

## **BIOLOGY**

Biology is a word derived from **two Greek** words i.e. “**Bios**” meaning **life** and “**logos**” meaning **knowledge**.

Therefore *Biology is a branch of science which deals with the study of life or living things*. All living things are called organisms.

### **BRANCHES OF BIOLOGY**

Biology as a science is very wide and has many branches which include the following;

- 1. Botany**, the study of plants.
- 2. Zoology**, the study of animals.
- 3. Anatomy**, the study of the structure of living things.
- 4. Nutrition**, the study of food and how living things feed.
- 5. Ecology**, the study of how organisms are related to their environment / surrounding.
- 6. Mycology**, the study of fungi.
- 7. Virology**, the study of virus.
- 8. Bacteriology**, the study of bacteria.
- 9. Entomology**, the study of insects.
- 10. Microbiology**, the study of microorganisms.
- 11. Physiology**, the study of process and functioning of the body parts.
- 12. Genetics**, the study of inheritance.
- 13. Taxonomy**, the study of classification of organisms
- 14. Ornithology**, the study of birds.
- 15. Ichthyology**, the study of fish.

### **WHY DO WE STUDY BIOLOGY? (IMPORTANCE OF STUDYING BIOLOGY)**

- To get knowledge on how to treat the sick
- To shape for our future careers such as doctors, opticians and nurses
- To get knowledge on how to manufacture drugs (pharmacists)
- To get knowledge on how to conserve the environment
- To know how our body functions.

### **CHARACTERISTICS OF LIVING THINGS**

A living thing is biologically known as an organism, for example man, plants, animals, birds, insects.

All living things share certain basic features called characteristics of living things.

- 1. Nutrition/feeding**

It's a process by which living things obtain food from the environment.

All living things take in food from which they obtain materials for energy production, body growth, and Repair.

Green plants make their own food while the rest obtain already made food from the environment.

## **2. Respiration**

This is the breakdown of food to release energy in the body using oxygen obtained from the environment.

## **3. Excretion**

Is the process by which waste products are removed from the body e.g. urea in urine, carbon dioxide, etc.

## **4. Reproduction**

This is the ability of an organism to give rise to new organisms similar to the parent.

## **5. Movement**

This is the ability of an organism to transfer its body from one place to another. They move in search for food, water, shelter, mates, and run away from predators.

## **6. Growth**

Growth is a permanent increase in size of an organism. It is followed by development.

## **7. Irritability / sensitivity**

It is the ability of an organism to respond to changes in its environment

### **DIFFERENCES BETWEEN PLANTS AND ANIMALS**

<b>Plants</b>	<b>Animals</b>
i) Have cell wall.	Lack cell wall.
ii) Have chlorophyll.	Lack chlorophyll.
iii) Movement is by growth of plant parts.	Movement involves the whole organism.
iv) They make their own food by photosynthesis.	Feed on already made food.
v) Respond to stimulus slowly since it involves growth.	Quick / immediate response to stimulus.
vi) Growth occurs throughout life	Growth is up to maturity and no further growth after.
vii) Growth occurs in particular plant parts	Growth occurs all over the body.

### **TOOLS USED TO STUDY BIOLOGY**

## 1. HAND LENS:

A normal hand lens is a convex lens mounted in a frame. It is placed a shorter distance of about 5cm from the eye and the object.

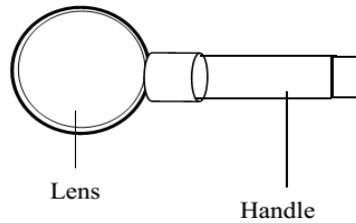

### Determination of magnification using a hand lens

Magnification refers to how much larger the object appears compared to its real size.

$$\text{Magnification} = \frac{\text{Size of image/drawing}}{\text{Size of object}}$$

### Example

Calculate the magnification of an object, which is 10cm tall whose image appears to be 20cm tall.

### Solution

Using the formula

$$\text{Magnification} = \frac{\text{Size of image/drawing}}{\text{Size of object}}$$
$$= \frac{20 \text{ cm}}{10 \text{ cm}}$$
$$= \times 2$$

*(Teacher should give more examples on calculations)*

## 2. MICROSCOPES

There are two types of microscopes i.e.

- The electron microscope which uses a beam of electrons.
- The compound light microscope.

### THE COMPOUND LIGHT MICROSCOPE

It is called so because it uses a beam of light to view objects and has more than one convex lens. It is used in hospitals, schools and some industries.

### Structure of a compound light microscope

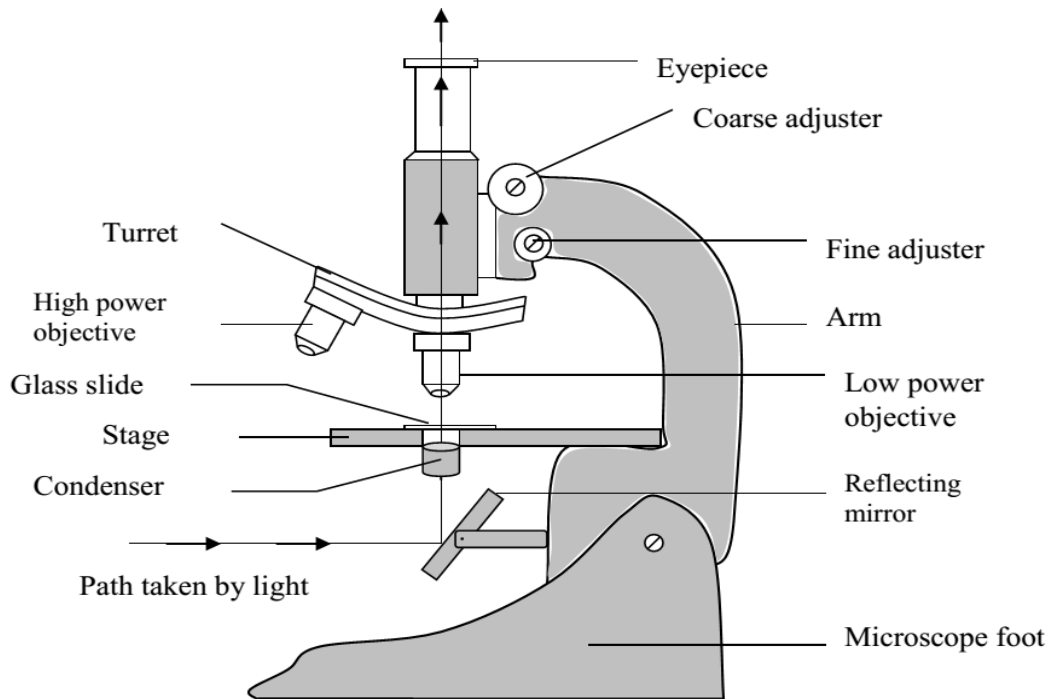

## FUNCTIONS OF THE DIFFERENT PARTS

### 1. Eye Piece:

- Enables one to view the specimen
- It magnifies the image from the objective lens.

### 2. Barrel:

- Provides support for the eye piece and objective lens.

### 3. Nose piece/ turret/:

- It holds the objective lenses in position
- Can be rotated to position a particular lens required for a particular magnification.

### 4. Stage:

- It is where a prepared slide is placed for observation.

### 5. Mirror:

- It reflects light from external source through the specimen.

### 6. Stand / Base:

- Supports instrument in on a flat surface.

### 7. Diaphragm:

- Regulates the amount of light passing through the specimen.

### 8. Condenser:

- Concentrates the light reflected by the mirror through the object / specimen on the stage.

### 9. Arm:

- Used for carrying the instrument.

**10.Clip:**

- Keeps the slide firmly on the stage.

**11.Coarse adjustment knob:**

- Used for focusing of the object under study.

**12.Fine adjustment knob:**

- Brings specimen into a sharp clearer focus (final focusing).

**13.Objective lens:**

- Magnifies the specimen under study. They are normally two or three. Low power (shortest), medium power and high power (longest).

**Care of a microscope**

The microscope is very delicate, expensive instrument which is very useful in the study of biology. Thus it should be handled carefully doing the following;

- It should be carried with both hands.
- Should never be dropped.
- Always kept in an upright position
- Only wipe the lens with soft lens tissue.
- It should always be kept in its special designed box.

**Determination of magnification of a microscope**

Magnification refers to how much larger the object appears compared to its real size.

Magnification = magnification of the eye piece lens X magnification of the objective lens.

**Example:**

If the eye piece is marked **x10** and the magnification of the objective lens is **x40**, what is the total magnification of a microscope?

Magnification = magnification of the eye piece lens x magnification of the objective lens.

$$=10 \times 40=400$$

The specimen was magnified *x400*

Let magnifying objective lens. (x4)

**Complete the table below**

Eye piece lens	Objective lens	Magnification
X15	X7	
X60		X240
	X17	X340

## THE CELL

The cell is the smallest basic unit of life.

Unicellular organisms are only made up of a single cell e.g. amoeba, paramecium.

Multicellular organisms are made up of many cells e.g. man, cows, bean plant, etc.

### THE ORIGIN OF NEW CELLS

New cells are formed from already existing cells by a process called cell division.

The already existing cell is called a parent/ mother cell; and the new cells formed are called daughter cells.

### Structure of an animal cell

### STRUCTURE OF A PLANT CELL

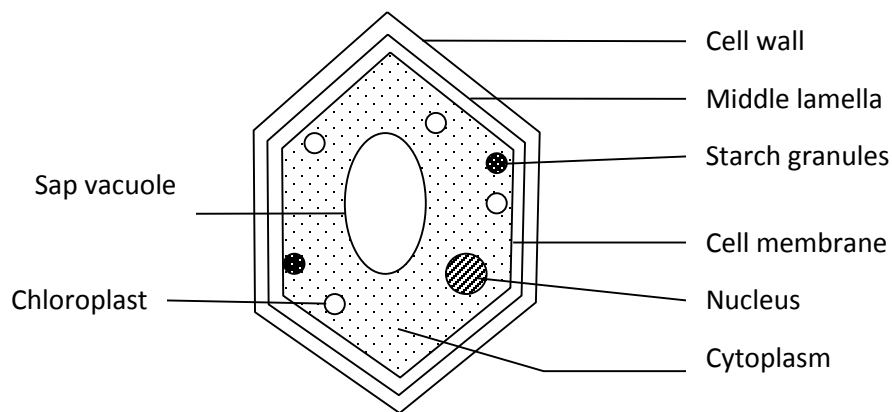

### CELL ORGANELLES

#### Parts of cell and their functions

#### 1. Cell Membrane

Is the outer living part of a cell and it is found in all cells.

Its semi permeable i.e. has tiny holes through which only very small molecules like water can pass through.

#### Functions

- It allows movement of materials of in and out of the cell.
- It regulates the shape and strength of a cell.
- Offers protection to the / inner parts of the cell.
- Binds protoplasm/ cytoplasm.

## **2. Cell Walls**

It is found in plant cells and it is made up of cellulose (a nonliving substance) which gives it its rigid tough nature.

### **Functions**

- It gives the plant cell its shape.
- Protects the inner parts of the cell cellular.
- Allows movement of materials in and out of the cell.
- It offers mechanical strength to the cell.

## **3. Nucleus**

It is surrounded by double membrane called the nuclear membrane.

### **Functions of a nucleus**

- Controls cell activities.
- Controls cell division
- Stores the genetic material of a cell
- Plays an active role in protein synthesis.

### **Functions of the nuclear membrane**

- Binds the nucleus
- Separates the nucleus plasma from the cytoplasm.
- Allows for the exchange of materials between the nucleus and the cytoplasm.

## **4. Cell Vacuole**

Contains a watery substance called cell sap and is surrounded by a single membrane called the tonoplast.

Each Plant cell possesses one large permanent central vacuole while each animal cell has many temporary vacuoles.

### **Functions**

- Stores waste materials before they are expelled.
- It is a temporary food store.
- Gives shape to the cell.

## **5. Cytoplasm**

It is a fluid material that contains many organelles e.g. mitochondria, nucleus etc.

### **Functions**

- Site for cell activities i.e. metabolic reactions.
- Site for storage of energy producing materials e.g. starch and glycogen.

## **6. Mitochondria**

It is the cell power house and its function is to release energy through respiration.

## 7. Chloroplast

Found in only plant cells

- Contains a green pigment called chlorophyll that traps sunlight for photosynthesis.

## 8. Golgi body

- Involved in cell secretions i.e. secretes enzymes.
  - It transports materials in cells.

## 9. Lysosome

It secretes hydrolytic enzymes i.e. breaking down enzymes e.g. help in destruction of old or worn out cells.

### COMPARING A PLANT AND ANIMAL CELL

#### Differences:

Plant cell	Animal cell
i) Regular in shape	Irregular in shape
ii) Has a cellulose cell wall.	Lacks a cellulose call wall.
iii) Has chloroplast.	Lacks chloroplast.
iv) Large vacuole centrally located.	Cell vacuole very small and positioned at the side.
v) Has a middle lamella.	Lacks a middle lamella.
vi) Nucleus is positioned at one side.	Nucleus centrally located.
vii) Store food as starch granules.	Store food as glycogen granules.
viii) Has a tonoplast around the vacuole	Has no tonoplast
ix) Has a Thin layer of cytoplasm	Has a thick layer of cytoplasm

#### SIMILARITIES:

##### Plant cell and animal cell

- Both have a nucleus.
- Both have mitochondria.
- Both have a Golgi body.
- Both have a vacuole.
- Both have a cytoplasm.
- Both have a cell membrane.

## **SPECIALISED CELLS**

These are cells modified to perform a particular function. They become suited or adapted for particular functions by modifying either their size, or shape, etc.

### **Examples of specialized cells in animals**

**i) Red blood cells in blood**

These transport oxygen in our bodies.



**ii) Sperm cells**

These fuse with the ovum to form a zygote during fertilization

**iii) Ovum or egg**

This is the female reproductive cell that fuses with a sperm to form a zygote.

**iv) White blood cells**

This defends the body against infections and diseases

**v) Platelets**

These are used for blood clotting.

### **Examples of specialized cells in plants**

**i) Root hair cells**

They are found in plant roots

They absorb water and mineral salts from the soil

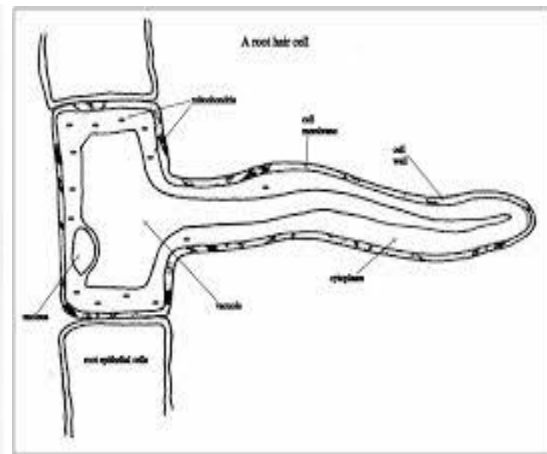
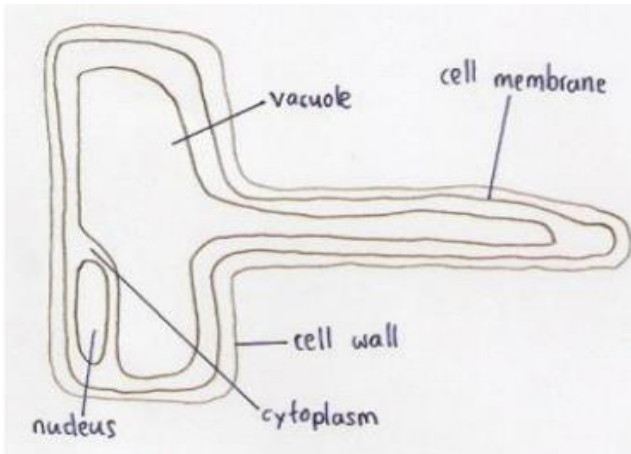

**ii) Palisade cells**

These are found in leaves of green plants  
They carry out the process of photosynthesis

**iii) Guard cells**

They are found in green leaves  
They control the opening and closing of stomata in leaves

**LEVELS OF ORGANISATION**

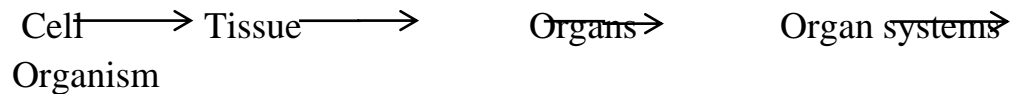

**TISSUE**

A tissue is a group of similar cells linked together to perform a particular function. A tissue may be made up of single type of cell or may comprise of different types of cells. E.g.

- i) Blood tissue made up of red blood cells, white blood cells and platelets. Blood transports materials in the body and offers protection.
- ii) Nervous tissue made up of nerve cells. It transmits impulses in the body.
- iii) Muscular tissue made up of muscle cells which cause movement of body parts
- iv) Photosynthetic tissue made of palisade cells for photosynthesis.

**ORGAN(S)**

An organ is a collection of tissues specialized in carrying out a specific function. An organ is made up of different types of cells grouped together as a unit eg

- i) eye for sight
- ii) Heart for pumping blood
- iii) Ear for hearing
- iv) Kidney for purifying blood
- v) Leaves for photosynthesis
- vi) Roots for absorbing water and mineral salts

## **ORGAN SYSTEM**

An organ system is a collection of different organs performing a specific function(s) e.g.

- i) nervous system (Brain, Spinal cord),
- ii) circulatory system (Heart, Lungs and Blood vessels),
- iii) Digestive system (gullet, stomach, small intestines).
- iv) Shoot system (leaves stems. flowers)
- v) Root system (roots)

## **ORGANISMS**

Is a collection of organ systems working together efficiently as a unit. E.g. man, cow, banana plant, etc.

## **CLASSIFICATION OF LIVING ORGANISMS**

Classification is the process of placing animals and plants into groups according to their similarities in structure, physiological processes and behavioral.

This involves collecting organisms, observing their structural characteristics and sorting them into groups known as *taxa*.

The branch of biology concerned with classification is called *taxonomy*.

The word taxonomy is derived from a Greek word taxis- meaning arrangement and nomia-meaning distribution.

## **LEVEL OF CLASSIFICATION**

The level of classification is called taxon. Plural –taxa. A taxon is a unit of classification made of similar organisms. The largest taxon is the kingdom and the smallest taxon is the species. All organisms have been put in seven major taxa and these include:

1. Kingdom
2. Phylum (phyla)
3. Class
4. Order
5. Family
6. Genus (genera)
7. Species

**Easy formula for seven taxa from highest to lowest**

Kings	Play	Cards	On	Fat	Green	Stools
K	P	C	O	F	G	S
(Kingdom)	(Phylum)		(Order)	(Family)	(Genus)	(Species)

**Kingdom**

A kingdom is the largest taxon, and all the other taxa (groups of living organisms) are placed in one the kingdoms. In modern classification system, there are 5 kingdoms:

1. Monera (bacteria)
2. Protoctista
3. Fungi (Mycota)
4. Plantae
5. Animalia

**Note:**

Viruses are not classified in any of the five kingdoms because they do not have all the characteristics of all living things. For example;

- ✓ They do not have cellular structures like cytoplasm, organelles.
- ✓ They use nuclear material and organelles of other living organisms to carry out their metabolic processes.
- ✓ They can survive out their host’s cell as inert organic crystals.

**Species**

A species is the smallest taxon which is made up of individuals that have almost the same characteristic features and can interbreed freely to produce viable off springs i.e. reproductively fertile off springs

**Examples of hierarchy system of classification**

	<b>Human</b>	<b>Honeybee</b>	<b>Maize</b>	<b>Meadow mushroom</b>
<b>Kingdom</b>	Animalia	Animalia	Plantae	Fungi
<b>Phylum</b>	Chordata	Arthropoda	Angiospermophyta	Basidiomycota
<b>Class</b>	Mammalia	Insect	Monocotyledoneae	Basidiomycetes
<b>Order</b>	primates	Hymenoptera	Commelinales	Agaricales
<b>Family</b>	Hominidae	Apidae	Poaceae	Agaricaceae
<b>Genus</b>	<i>Homo</i>	<i>Apis</i>	<i>Zea</i>	<i>Agaricus</i>
<b>Species</b>	<i>sapiens</i>	<i>Mellifera</i>	<i>mays</i>	<i>campestris</i>

### **Binomial system of nomenclature:**

Binomial nomenclature is the system of giving a scientific name to an organism.

The word binomial comes from two words bi- meaning two and nomial meaning name.

The first accepted classification and nomenclature was introduced by a Swedish scientist called Carl Linnaeus (1707 - 1778).

### **Rules of binomial system of nomenclature**

- ✓ Each organism should be given two Latin or Greek names which include generic (genus) name followed by specific (species) name.
- ✓ The generic name should start with a capital letter and a specific name starts with the small letter
- ✓ When written both names should be **underlined separately** or ***printed in italics***

### **Examples of some scientific name for common organisms**

Human – scientific name is *Homo sapiens*

Maize – scientific name is *Zea mays*

Assignment: write the scientific names of the following; honey bee, meadow mushroom and house fly.

### **Importance of classification**

- ✓ It is easy to study organism in a group since the members of a specific group resemble.
- ✓ It helps new organisms to be easily classified since they share certain characteristics with those in existence.
- ✓ It helps the scientist to easily identify organisms belonging to the same group.
- ✓ The use of scientific names enables to prevent confusion that would arise if the organism had different names used in different places.

## **KINGDOM: MONERA**

This basically comprises of bacteria which are prokaryotes





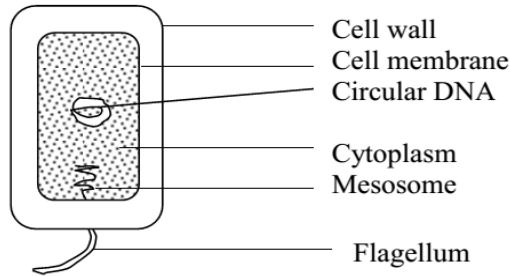

### **General characteristics**

- ✓ They are unicellular with cells occurring either alone or in colonies.
- ✓ The cells lack membrane bound organelles.
- ✓ The free living bacteria have flagella
- ✓ Some are parasitic and others are saprophytic
- ✓ The cell wall is covered with mucin
- ✓ They reproduce asexually by means of spores or binary fission.

## General structure of bacterium



Bacteria are grouped according to their shapes. There are four groups of bacteria

Shape	Type	Structure
<b>Coccus</b> Single spherical cells 	<b>Diplococcus:</b> These occur as a pair of spherical cells.	
	<b>Staphylococcus:</b> Spherical shaped occurring in a bunch or group	
	<b>Streptococcus:</b> Spherical cells in a chain	
<b>Bacilli:</b> These are rod shaped.	<b>Bacillus:</b> Single rod shaped bacterium.	
	<b>Diplobacilli:</b> A pair of rod shaped bacteria.	
	<b>Streptobacilli:</b> Rod shaped bacteria existing in a chain.	
	<b>Spherical spore bacilli:</b> These have spherical spore at the head e.g. clostridium tetani which causes tetanus	
<b>Vibrio:</b> Coma shaped	<i>Vibrio cholera</i> which causes cholera	
<b>Spirillus</b>	These are spiral shaped bacteria	

### **Economic importance of bacteria**

- i) Bacteria causes decay of dead plants and animals thus releasing nutrients for use by green plants
- ii) Rhizobium converts the nitrogen into nitrates in the soils
- iii) Bacteria manufacture vitamin B12 and k
- iv) Used in curing tea and tobacco, making silage /retting flax. Curing is process of treating and preserving tea / tobacco
- v) Bacteria destroys harmful organisms in sewage in the sewage treatment
- vi) Used in industrial processing of food like vinegar, cheese, and yoghurt
- vii) Symbiotic bacteria in ruminants help in digesting cellulose by secreting enzymes cellulose
- viii) Bacteria cause decay and food spoilage
- ix) Denitrifying bacteria converts nitrates in to free nitrogen in the soil.
- x) Some bacteria cause harmful diseases to man like anthrax.

### **KINGDOM: PROTOCTISTA**

Examples of protoctists are:

Amoeba, Euglena, Paramecium, Trypanosomes, Chlamydomonas, etc.

#### **Main features of Protoctista**

- i) They are unicellular organisms i.e. single celled organisms.
- ii) They have a true nucleus with a nuclear membrane.
- iii) They have double membrane organelles.
- iv) Some members locomote freely using either pseudopodia (false legs) in amoeba, cilia in paramecium or flagella in euglena and trypanosomes.
- v) They have varied forms of nutrition e.g. euglena and chlamydomonas make their own food by photosynthesis, amoeba and paramecium by phagocytosis and simple absorption of digested food by trypanosomes.
- vi) They live mostly in water or watery environments like wet lands.

### **PHYLUM PROTOZOA**

This is the main phylum of kingdom Protoctista. It has several classes but the most important are:

1. Rhizopoda e.g. Amoeba

These are free living organisms by means of pseudopodia or false legs

2. Ciliophora (ciliata) e.g. paramecium

These possess cilia all over the body for locomotion or movement.

3. Mastigophora e.g. trypanosomes.

These have a flagellum for locomotion.

### General characteristics of protozoans:

- ✓ They are unicellular.
- ✓ They are mainly found in fresh or marine water and in the soil.
- ✓ They are mostly free-living but some are parasites.
- ✓ They carry out locomotion by means of flagella, cilia or pseudopodia.
- ✓ Euglena have autotrophs and others protozoa-such as amoeba.
- ✓ They reproduce asexually by binary fission or multiple fission.

Examples of protozoa include Amoeba, Paramecium, Euglena, Trypanosome and plasmodium.

### 1. Amoeba

Amoeba is a free-living protozoa found at the bottom of ponds. It has temporary extensions called pseudopodia used for locomotion. The pseudopodia are also used for enclosing food particles which form food vacuoles. The food in vacuole is digested by phagocytosis.

The extra amount of water can be regulated by contractile vacuole.

### Structure of amoeba

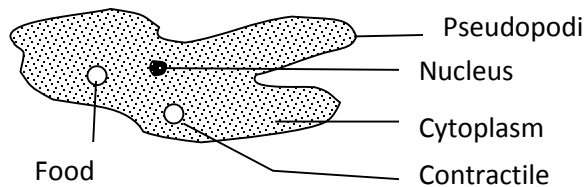

### Locomotion in amoeba:

Amoeba moves by means of pseudopodia (false legs) that are formed by the flow of cytoplasm (plasmosol and plasmogel) in the direction of movement but this is followed by the flow of other protoplasm in the same direction, as shown be:

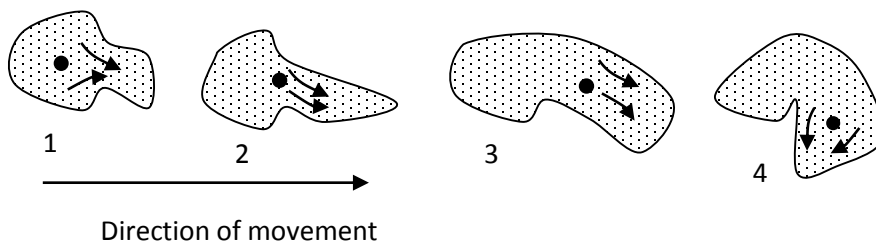

The movement of amoeba is mainly determined by factors e.g. water, food, poison, acidity, alkalinity, etc. and it will make amoeba move towards or away from such factors.

### Excretion in amoeba

Excess water is eliminated from its body by contractile vacuole. This collects the water and moves from cell membrane where it discharges its contents. The process is repeated and hence it is the means of osmoregulation by amoeba. Other by-products diffuse out of the cytoplasm through the cell membrane e.g. CO<sub>2</sub>.

### Feeding

Amoeba feeds on microscopic algae and bacteria. It captures the food by developing pseudopodia around the food and it engulfs it. The cytoplasm flows around the food. This one now forms the food vacuole.

Digestive enzymes are produced which break the food particles into soluble food substances. The products are utilized and amoeba moves away from undigested food remains. This is called **egestion**.

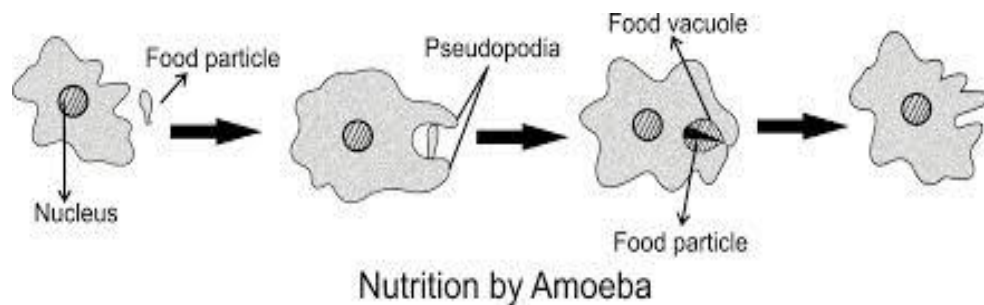

### Reproduction in amoeba

Amoeba reproduces by binary fission.

#### Binary fission in amoeba;

- i) An amoeba ready to reproduce stops moving and rounds off.
- ii) The nucleus then constricts and divides into two identical parts. This will be followed by nucleus complete separation as the cytoplasm begins to constrict so that the separation of the remaining parts into 2 can occur.
- iii) Two identical daughter amoebae forms and move apart to feed and grow into mature amoebae before they divide again.

Illustration

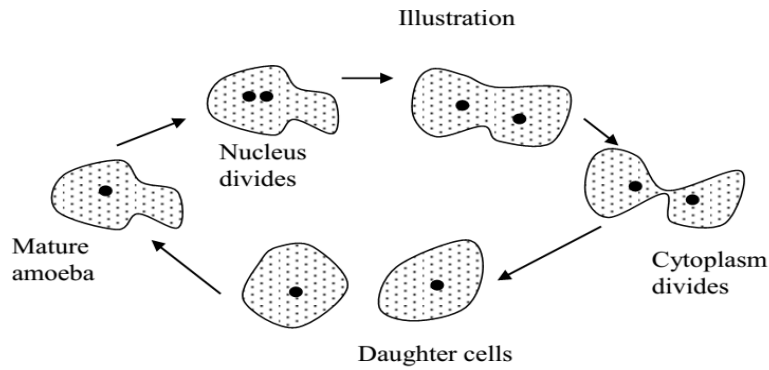

## 2. Paramecium

Paramecium uses cilia for movement and collection of food. It has special row of cilia that waft food particles into the hollow gullet. The food vacuoles move in a very definite path through it and egestion occurs at only one point near the region of ingestion.

### Structure of paramecium

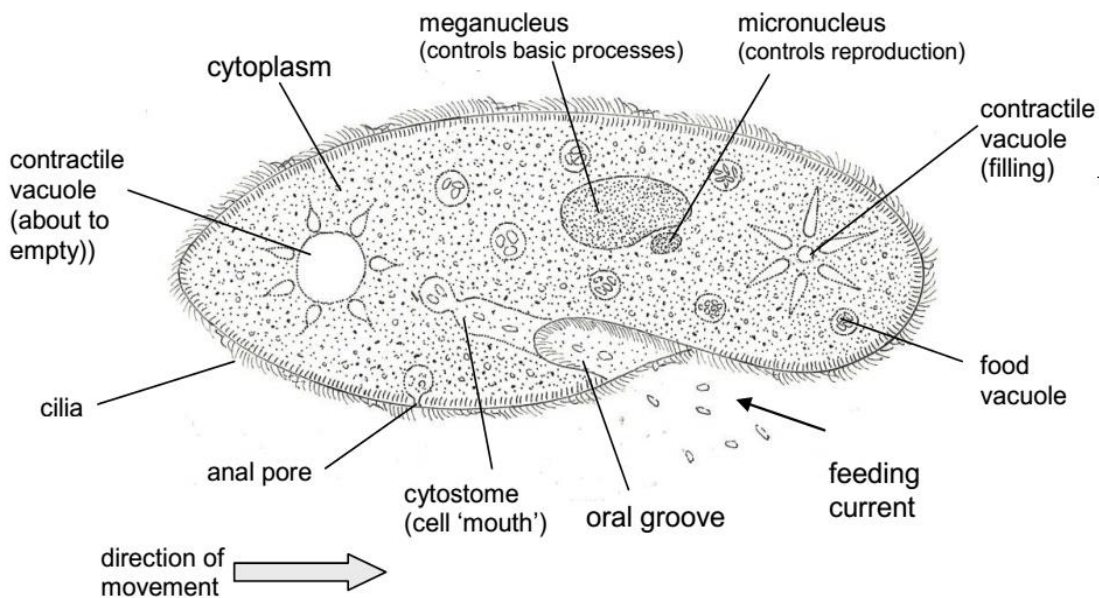

Unlike amoeba, paramecium has a distinct and permanent shape and certain areas of cytoplasm, (cell organelles), are specialised to carry out specific functions.

### 3. Euglena **No. 2**

This is commonly found in water and in soil. It is photosynthetic and moves by means of flagellum.

#### Structure of euglena

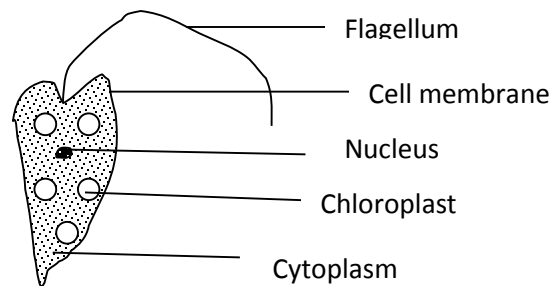

### **KINGDOM: FUNGI**

Kingdom fungi mostly have multicellular eukaryotic organisms such as mushroom and mould. Some are unicellular like yeast.

Other examples include toad stool, smuts, penicilium, mucor (grows on soil and dead plants), Rhizopus (common bread mould).

Rhizopus is saprophytic fungus which grows on decaying food like bread and fruits.

#### **General characteristics**

- ✓ Are multicellular except a few e.g. yeast.
- ✓ Fungi inhabit damp or aquatic plants
- ✓ They reproduce by means of spores. They have saprophytic or parasitic mode of nutrition.
- ✓ Have vegetative body called mycelium which consists of a network of hyphae.
- ✓ They have cell walls which consist of a material called chitin.
- ✓ They lack chlorophyll though majority are plant-like.

#### **Diagram of common bread mould (Rhizopus)**

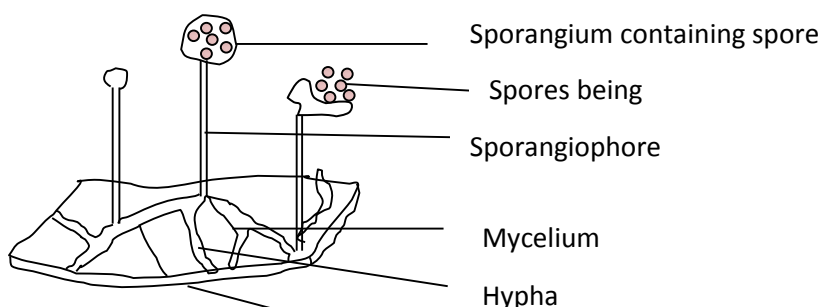

## Structure of a mushroom

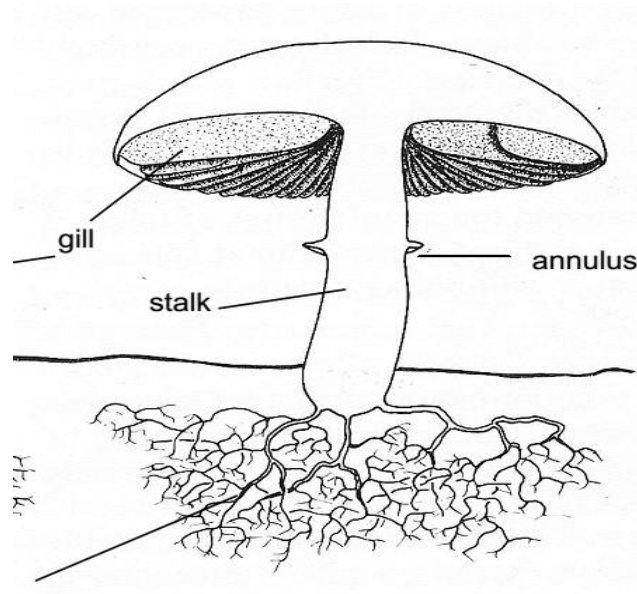

### Sexual reproduction

- i) Sexual reproduction involves the fusion of the male and female gametes to form a zygote.
- ii) During sexual reproduction, the two different hyphae face each other and become swollen. The nuclei from each tip develop.
- iii) The tips meet and form a cross wall.
- iv) The cross wall breaks and nuclei from different tips pair and fuse.
- v) A zygote is formed which develops a thick wall to form a zygospore.
- vi) The zygospore remains dormant under unfavorable conditions and germinates into a new mycelium in favorable conditions.

## Illustrations:

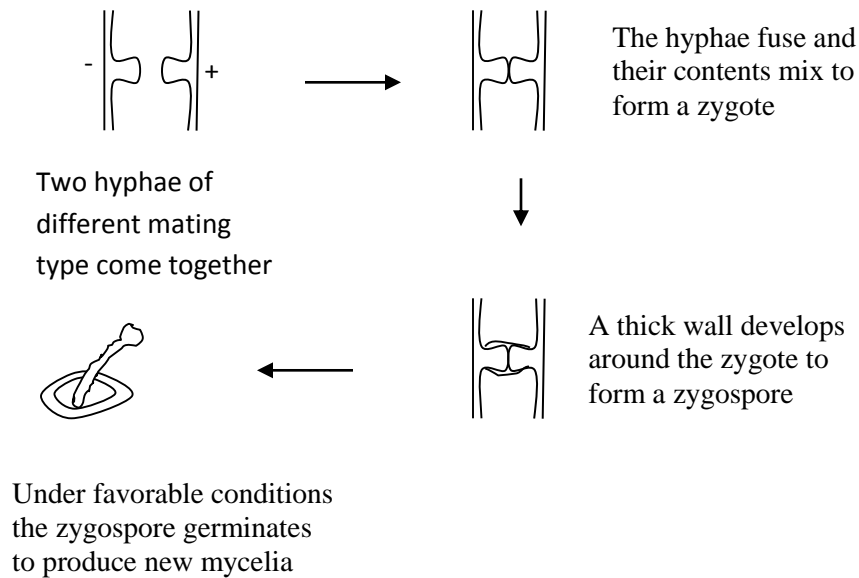

## Economic importance of fungi

- ✓ Fungi decay dead organic materials to release materials needed by green plants
- ✓ Yeast respiring anaerobically, provides alcohol for brewers and wine makers.
- ✓ Yeast cells are a source for vitamin **B** extract
- ✓ Fungi produce antibiotics e.g. penicillum.
- ✓ Fungi provide food e.g. mushroom also used in making cheese.
- ✓ Fungi can spoil food e.g. Rhizopus and penicillum on the bread, cakes, fruits and jam.
- ✓ Fungi causes plant disease e.g. rust, white bright and smut.
- ✓ Dry rot fungus attacks the timber of houses.
- ✓ Fungi causes diseases to man e.g. ringworm, athlete's foot.
- ✓ Fungi can be used by military to prepare biological weapons to be used in the war fare.

## KINGDOM ANIMALIA

Kingdom Animalia has several phyla each of which consists of a variety of organisms.

The phyla include

1. Porifera e.g. sponges

2. Coelenterata e.g. hydra
3. Platyhelminthes e.g. flat worms
4. Nematoda e.g. round worms
5. Annelida e.g. ringed worms
6. Mollusca e.g. snails
7. Echinodermata e.g. star fish
8. Arthropoda e.g. cockroach
9. Chordata e.g. man

### **General characteristics**

- i) Animals carry out locomotion
- ii) They have heterotrophic mode of nutrition
- iii) They are multicellular organisms.
- iv) Their body has a definite shape.
- v) They have cells without cellulose but contain true nucleus.

### **1. Phylum: Porifera – the sponges**

The phylum is made of many types of sponges. They have the following characteristics:

- i) Possess simple bodies which are hollow and sac-like.
- ii) They are marine dwellers
- iii) They are sedimentary or sessile organisms found attached to the rocks or coral reefs
- iv) Some can live in colonies or individually.
- v) They lack a nervous system.
- vi) They have only one opening in their bodies.
- vii) They have a body made up of two layers of cells i.e. ectoderm and endoderm.

### **2. Phylum: Coelenterata (Cnidaria)**

They include the following; the jelly fish, sea anemones, hydra and corals.

They have the following characteristics:

- i) They are multicellular organisms.
- ii) They are aquatic or marine organisms.
- iii) They have soft bodies which are sac-like with body cavity called enteron
- iv) They have radial body symmetry.
- v) They have a single body opening.
- vi) They have tentacles.
- vii) They possess specialized cells such the stinging cells used for defense or paralyzing their prey.
- viii) They have a ring of tentacles for capturing prey.

## Hydra structure

### 3. Phylum: Platyhelminthes (flat worms)

The phylum consists of organisms like flukes and tape worms. They have the following characteristics:

- ✓ They have dorso-ventrally flattened body
- ✓ They have bilateral body symmetry.
- ✓ They are damp, moist or aquatic dwellers.
- ✓ They are parasitic organisms.
- ✓ They have alimentary canal without mouth.
- ✓ The body wall has three body layers of cells (triploblastic) i.e. ectoderm (outer), mesoderm (middle) and endoderm (inner).
- ✓ The gut is branched to increase surface area over which digested food is absorbed.
- ✓ They are hermaphrodites; have both male and female organs in the same organism.
- ✓ They lack blood circulatory system and because of that, the gaseous exchange occurs by simple diffusion all over the body surface.

The phylum has 3 main classes;

- i) Turbellaria e.g. Planarians
  - ✓ They are free living flat worms that live in wet soils, fresh water and seas.
  - ✓ They have many simple eyes and cilia on the under surface of the body used for movement over stones and weeds.
- ii) Trematoda e.g. Liver fluke

- ✓ They live as endo parasites in cattle, goats and man.
- ✓ They have no cilia on their body and lack simple eyes
- ✓ They have suckers used for attachment on to the host.
- ✓ They suck digested food from the host.

iii) Cestoda e.g Tape worm

- ✓ They live as endo-parasites in the gut of man, muscles of goats, cows and pigs.
- ✓ They have suckers and hooks for feeding and attachment on to the host.
- ✓ They have elongated bodies consisting of segments called proglotids.
- ✓ They absorb digested food directly from the host.

#### **4. Phylum: Nematoda ( round worms)**

The phylum has the examples like hookworms, pin worms, guinea worms, whip worms and ascaris lumbricoides. They have the following characteristics:

- ✓ They have segmented bodies.
- ✓ They have elongated and cylindrical bodies pointed at both ends.
- ✓ They have closed circulatory system.
- ✓ They have gaseous exchange occurs all over the body surface.
- ✓ They have a complete digestive system with both mouth and anus.
- ✓ Some are parasitic and others are free living.

#### **5. Phylum: Annelida (ring worm)**

These are the ringed or segmented worms e.g. earthworms, leeches, rag worms, lugworms, etc. They have the following characteristics:

- ✓ The body wall has three body layers of cells (triploblastic) i.e. ectoderm (outer), mesoderm (middle) and endoderm (inner).
- ✓ They have true coelom.
- ✓ They have a closed circulatory system.
- ✓ They have gaseous exchange all over body surface.
- ✓ They have complete digestive system with both anterior (oral) and posterior (Anal) openings.
- ✓ They are hermaphrodites and reproduce sexually but they often promote cross fertilization.
- ✓ They are carnivorous and some live as external parasites.
- ✓ They have bodies divided into section called septae.

✓ Externally the body shows ring- like segments.

i) Earthworm

ii) leech

## **6. phylum: Mollusca**

The organisms are generally aquatic and live both on fresh water and marine. Examples include snails, slugs, octopus, squids, mussels and oysters. They have the following characteristics:

- ✓ They have soft and unsegmented bodies.
- ✓ Nearly all have shells with exception of octopus and squids.
- ✓ The foot is used for locomotion and attachment to the substratum.

i) Garden snail

## **7. Phylum: Echinodermata**

The organisms are sea dwellers. Examples are bristles star, sea urchin, sea lilies, sea star, star fish, sea cucumber. They have the following characteristics:

- ✓ They have unsegmented bodies.
- ✓ They have radial body symmetry.
- ✓ The bodies have five arms.
- ✓ The body wall has three body layers of cells (triploblastic) i.e. ectoderm (outer), mesoderm (middle) and endoderm (inner).
- ✓ They have feet for locomotion and capturing the food (feeding).
- ✓ They have spiny skin which is a hard plate.
- ✓ They have water vascular system instead of blood circulatory system.

Structure of star fish

## **PHYLUM ARTHROPODA**

Arthropoda has a wide variety of animals. These animals occupy a wide variety of habitats on land, sea and fresh water.

### **Main characteristics**

- i) They have a segmented body.
- ii) Presence of an exoskeleton that is shed periodically.
- iii) They have jointed limbs and appendages for feeding, locomotion, and irritability.
- iv) They have bilateral symmetry. This is the ability the body of an organism to be divided into two identical parts.
- v) They have an open circulatory system, where blood flows in open spaces.
- vi) They have a well-developed nervous system
- vii) They have a complete gut that runs from the mouth to the anus

**Note:** The exoskeleton is made up of chitin which is a fairly firm but flexible carbohydrate. The exoskeleton provides support to terrestrial arthropods. It also provides points of attachment for the muscles.

The exoskeleton prevents the desiccation of the body by secreting wax. The exoskeleton also protects the organism from mechanical injury.

The phylum comprises of classes **Crustacea, Chilopoda, Diplopoda, Insecta and Arachnida.**

### **1. Class: Crustacea**

Crustacea are organisms whose body is covered by a carapace. A carapace is a hard shell. Examples of members of the class Crustacea include crabs, crayfish, lobsters, prawns, woodlice and shrimps.

### **Distinguishing characteristics**

- ✓ Crustacea are mainly found in marine and fresh water. Thus, they occupy aquatic habitats.
- ✓ They breathe by means of gills through the body membrane.
- ✓ Their body is divided into two parts. Their head and thorax are fused to form a cephalothorax. The second division is the abdomen.
- ✓ They have a pair of compound eyes each on a raised stalk.
- ✓ They have two antennae and small short pair called atenules.
- ✓ They have four pairs of mouthparts namely: maxilla, mandible, labium and labrum.
- ✓ They have five pair of limbs that are modified for swimming.

## **2. Class: chilopoda**

Chilopoda is made up of centipedes. The centipedes are mainly found on land.



### **Distinguishing characteristics**

- ✓ Centipedes have a clearly defined head while the rest of the segments are similar.
- ✓ They have a pair of antenna

- ✓ They have one pair of mouthparts known as mandibles.
- ✓ They have simple and compound eyes, although some lack compound eyes.
- ✓ They have one pair of legs in each body segment.
- ✓ They carry out gaseous exchange by means of a trachea
- ✓ They feed on insects and worms.
- ✓ They occupy terrestrial habitats.
- ✓ Their body is flattened dorso-ventrally.
- ✓ They have one pair of poison claws.

### 3. Class: Diplopoda

Class Diplopoda is made up of millipedes. Millipedes are common on damp places.



#### Distinguishing characteristics

- ✓ Millipedes have a clearly defined head. All the other body segments are basically similar.
- ✓ They have one pair of antenna
- ✓ They have one pair of mouthparts, namely the mandibles.
- ✓ They have simple and compound eyes. In some cases, the millipedes may not have compound eyes.
- ✓ They have two pairs of legs in each segment.
- ✓ They carry out gaseous exchange through the trachea.
- ✓ They feed on plants.
- ✓ They inhabit terrestrial habitats.
- ✓ They have a cylindrical body
- ✓ They have the ability to coil when disturbed or not active.

**Note:** *class Chilopoda and Diplopoda used to be classified as class Myriapoda but now are classified into different classes.*

### 4. Class: Arachnida

Arachnida are terrestrial arthropods. Members of this class all have 8 legs. Examples of arachnids include spiders, ticks, scorpions and mites

### **Distinguishing characteristics**

- ✓ Arachnida have two body parts. The head and thorax are fused to form the cephalothorax or prosoma (cephalothorax). The abdomen is referred to as opisthosoma.
- ✓ They do not have antenna but have a pair of pedipalp which they use for sensory and defense purposes.
- ✓ They do not have mouthparts. However, they have one pair of appendages for sensing prey. This pair of appendages is known as chelicerae. Thus, they have a carnivorous mode of feeding.
- ✓ They have simple eyes.
- ✓ They have four pairs of walking legs.
- ✓ They carry out gaseous exchange by the lung book or trachea. A lung book consists of folds of ectoderm with slit-like openings on the surface of the abdomen
- ✓ Arachnids do not have wings.
- ✓ They inhabit terrestrial habitats.

### **5. Class: Insecta**

Insects are the most successful animals on earth since they possess an exoskeleton which reduces water loss from the body.

Insects are the largest group of arthropods.

They occupy every habitat on earth in such places as air, soil and water. However, they mainly inhabit terrestrial habitats. Examples of insects include grasshoppers, houseflies, butterflies, bees, and termites.

### **Distinguishing characteristics**

- i) Insects have three body parts, namely: the head, thorax, and abdomen.
- ii) They have one pair of antenna.
- iii) They have a pair of compound eyes. In some case, simple eyes are also present.
- iv) They have three pairs of walking legs on the thorax. One pair of walking legs per segment of the thorax.
- v) Most insects have one or two pairs of wings on the second and/ or the third segment of the thorax. Some insects have no wings.

- vi) They breathe by means of spiracles and carry out gaseous exchange in the tracheal system.
- vii) They undergo complete or incomplete metamorphosis with a larval stage.
- viii) Some insects such as ants are carnivorous while others such as grasshoppers are herbivorous.

They exhibit the longest level of organization in animals, i.e. social organization especially in bees, wasps and ants. They are the only invertebrates which can fly.

**Their success on land is attributed to:**

- i) Evolution of special organs for flight. The wings which enable them to diverse and colonize new areas.
- ii) Impervious exoskeleton made of chitin which has protected them from drying up in the terrestrial environment.
- iii) The small size has enabled them to tackle every place.
- iv) Excretion of toxic products as uric acid has enabled them to conserve water
- v) Tracheal system has enabled them to carry efficient gaseous exchange.
- vi) Disposition of legs enables them to maintain swift locomotion.
- vii) The compound eyes that provide wide field of view for food and enemies.
- viii) The modified mouth parts that suit a variety of food materials.
- ix) The high reproductive rate that ensures enormous number of offsprings is produced.

Some insects are directly beneficial to man these include pollinators like butterfly, moth and bees others are beneficial indirectly such as parasitic pest species.

Harmful insects include those that directly live on man as parasite like lice, flies, mosquitoes, tsetse flies.

**INSECT METAMORPHOSIS**

Metamorphosis is the gradual developmental change from the eggs to the adult stage.

It occurs in insects and amphibians. Insect metamorphosis is divided into two types.

### 1. Complete metamorphosis (holometabolous);

This is a gradual development change where the eggs hatch into larvae and the larvae change into pupa and finally the pupa change into an adult. It involves four stages.

#### Illustration of complete metamorphosis.

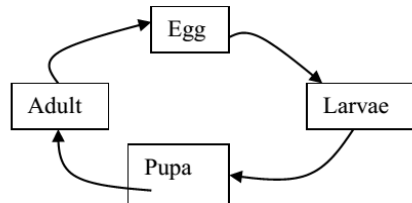

Insects, which undergo complete metamorphosis, include butterflies, mosquitoes, houseflies, tsetse flies, bees, wasps, and beetles.

### 2. Incomplete metamorphosis (hemimetabolous);

This is the gradual developmental change where an insect undergoes only 3 stages, when eggs hatch, they give rise to adult-like nymphs which latter change into adults. Insects showing this include locusts, grasshoppers, bedbugs, cockroaches, and termites.

#### Illustration of incomplete metamorphosis

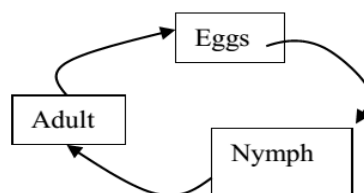

#### Some common orders of insects

Order	Characteristic feather of the order ( <i>the word ptera means wing</i> ).	Examples
Dictyoptera	Has hard outer wings	Cockroach, beetles, weevils.
Hymenoptera	Has membranous wings	Wasps, bees
Isoptera	Has similar wings	Termites
Lepidoptera	Has scale wings	Moths, butterflies

Diptera	Have two pairs of wings. The second pair is reduced into halteres for balancing.	Mosquitoes, houseflies
Orthoptera	Has long straight wings	Grasshopper, locusts, Preying mantis

## **CITRUS BUTTERFLY**

*(Papilio demodocus)*

The citrus butterfly is also referred to as lime butterfly because it feeds on lime and citrus.

### **Classification**

Kingdom	:	Animalia
Phylum	:	Arthropoda
Class	:	Insecta
Order	:	Lepidoptera
Family	:	Papilionidae
Genus	:	Papilio
Species	:	demodocus.

### **Characteristics of order Lepidoptera**

- ✓ They are small to large insects with entire covering of powdery scales on their wings. (lepis-scale and ptera- wing)
- ✓ Wings are fastened together.
- ✓ No anal cerci.
- ✓ metamorphosis is complete.
- ✓ Sucking proboscis straightened when feeding but coils underneath the head when not actively feeding.

### **Habitat**

Butterflies live in gardens and forests and where they can feed on nectar from flowers. They are active during day.

### **External features**

The butterfly has three body divisions the head, thorax, and abdomen.

## The head

- ✓ The head bears two large, bulging brown compound eyes.
- ✓ There are two simple eyes (ocelli) behind the compound eyes.
- ✓ Above eyes is pair of antenna. These are long jointed and lobbed at the ends. They are sense organs for touch and smell.
- ✓ The head also bears the mouth part specially adapted for sucking nectar. The sucking part is long, hollow and flexible tube called proboscis. This has a modified pair of maxillae which coils up when not in use.
- ✓ The mandibles, the labium and labrum are poorly developed and hardly used.

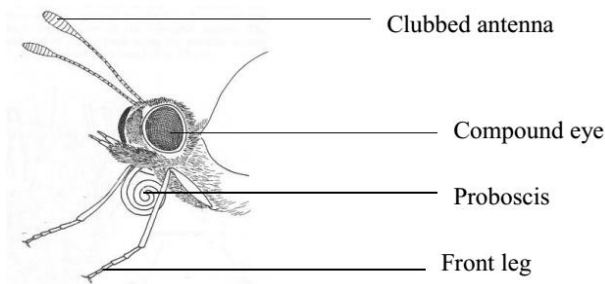

## The thorax

The thorax consists of prothorax, mesothorax and metathorax. These segments are covered by hairs and divisions are not clearly seen.

Each thoracic segment bears a pair of jointed walking legs.

The mesothorax and Metathorax in addition bear a pair of wings each which are large and membranous.

They are veined and covered by colored scales.

When the butterfly is flying, the wings are spread out but when at rest, the wings are raised and held vertically above the body.

## The abdomen

The abdomen has ten segments and each bears a pair of spiracles.

It is hairy and obscures the segmentation.

## Butterflies and moths

Butterflies and moths are both members of the Lepidoptera. Although they appear very similar, there are differences in their bodies and behaviour.

### Differences between a butterfly and a moth

Butterfly	Moth
It is diurnal i.e. active during day time	Nocturnal i.e. active during night
Wings are held upright at rest.	Wings are held horizontally at rest.
Small body	Fatter body
Body brightly colored	The body is dull
Antennae are clubbed or knobbed at the tip	Antennae are pointed at the tip and feathery
Pupate above the ground	Pupate in cocoons or in the soil

### The life cycle of a butterfly

A butterfly undergoes complete metamorphosis.

A female butterfly ready for reproduction produces a peculiar scent that attracts the male for mating.

During mating, the male butterfly deposits the sperms in the genital opening of the female. The eggs are then fertilized internally.

**The eggs** are laid singly or small batches on the under surface of young leaves of citrus plant. This protects them from damage by heat of sun or rain. The eggs are tinny, spherical, white or greenish-white in colour.

**The eggs hatch into larvae (caterpillars) after about 3 days.**

The newly hatched caterpillars are small and black. They have powerful mandibles for feeding, first, the egg shell and later young leaves. The young caterpillar has horn- like body with head, thorax, and abdomen. The thoracic segments bear each a pair of true walking legs and abdomen bearing a pair of claspers on the last segment.

The caterpillar moults four times in three weeks before changing to a fully mature caterpillar which majorly feed on leaves.

**The caterpillar then pupates into pupa.**

The fully developed caterpillar stops feeding and finds a suitable place usually a vertical twig to pupate. It spins a silk pad on the twig and attaches its claspers to it. It then spins its thorax and suspends itself in a slanting position with anterior end pointing upwards. The caterpillar then moults for its last time and changes into pupa (chrysalis). The pupa is inactive i.e. it does not feed nor move.

During pupa stage- there is internal reorganization of tissues involving the formation of wing, compound eyes, proboscis and reproductive organs. This lasts for about 7-10 days after which the pupa case split along the dorsal region. After about 1 hour while the wings expand and dry, the adult butterfly emerges ready to fly away, feed, mate and lay more eggs.

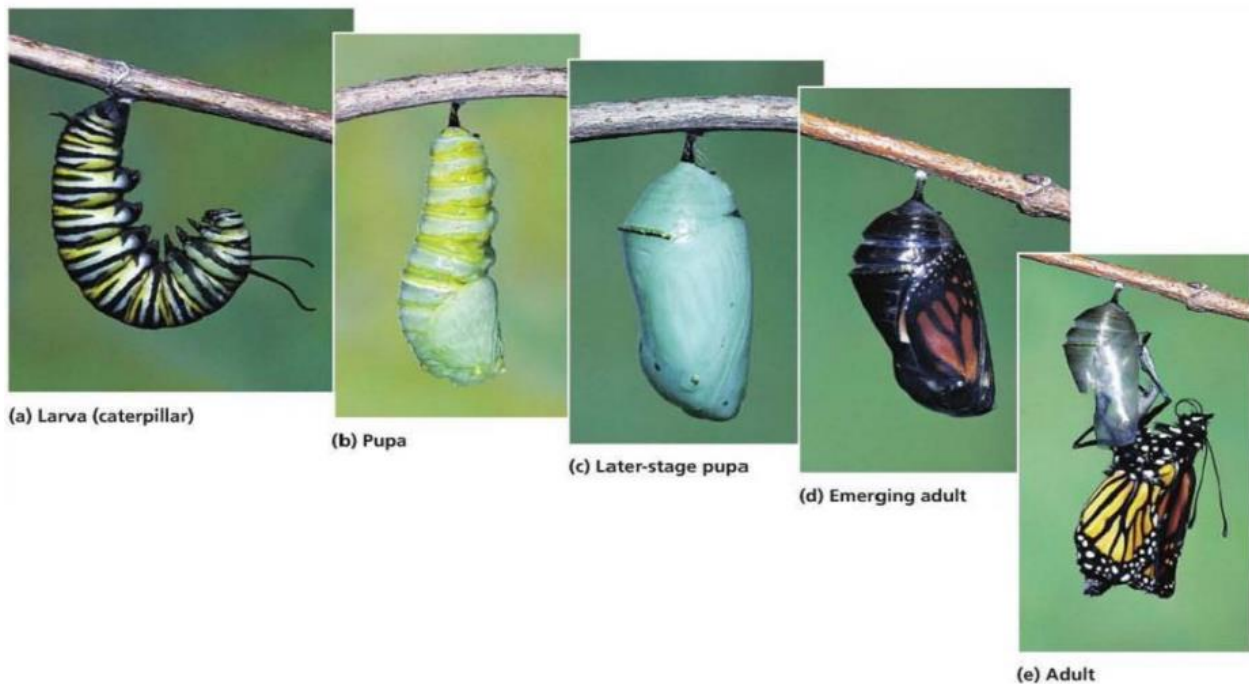
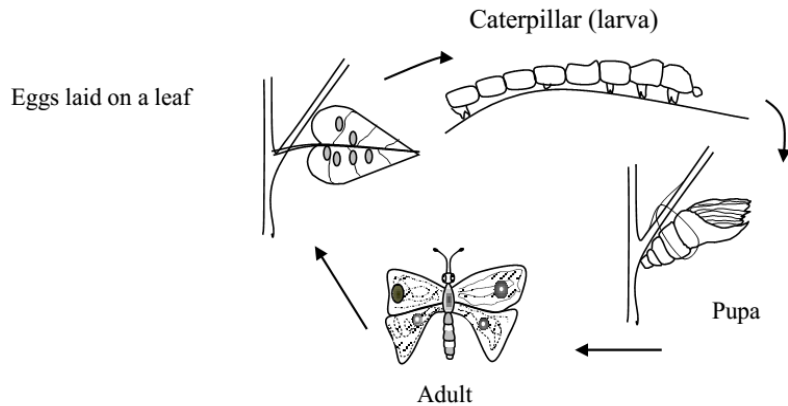

### **Economic importance of citrus butterfly**

- i) From the cocoons of butterfly, silk threads are obtained for making silk clothes.
- ii) The larvae spoil the leafy vegetable with fecal drops such as dodo.
- iii) The scales may be respiratory hazards when inhaled.
- iv) The caterpillar stage of a butterfly is significantly destructive on vegetables including crops such as cabbages, maize, millet sorghum etc. . . .
- v) Some caterpillars feed on insects thus help in destroying insect pests.
- vi) Butterflies can also be used as decorations because of their beautiful colour patterns (ornamental purpose) used in art industry.

vii) The butterflies also are of much importance to the farmers in pollinating flowers of the crops.

### **Control measures against butterflies**

- i) Apply environmental friendly insecticides
- ii) Use of biological control methods
- iii) By hand picking of the infected leaves and burning or burying them. This destroys the eggs and some leaves.

## **COCKROACH**

(*Periplaneta americana*)

The common species of cockroach in the tropics is *Periplaneta americana*. This is most active at night, during day it hides in dark places and crevices of walls.

### **Classification**

Kingdom : Animalia  
Phylum : Arthropoda  
Class : Insecta  
Order : Dictyoptera  
Family : Blattidae  
Genus : *Periplaneta*  
Species : *americana*

### **Characteristics of order: Dictyoptera**

- ✓ The mouth parts are of the biting type
- ✓ presence of broad membranous outer wings
- ✓ long and thread- like antennae
- ✓ possession of the anal cerci
- ✓ presence of long and tough tegmina
- ✓ Metamorphosis is incomplete.

### **Habitat**

Cockroaches live in dark, dirty and damp warm places e.g. pipes that carry sewage. During day they live in crevices of walls, cupboards, underneath drawers and in boxes.

They are active at night thus referred to as nocturnal.

### **Adaptation of a cockroach to its environment**

- i) Cockroaches have dorso-ventrally flattened bodies to fit in narrow places.

- ii) Its body is dark brown to camouflage well against a dark background.
- iii) They are smooth and greasy to escape easily from predators.
- iv) It has one pair of long antennae for feeling and smelling the area around their body.
- v) The shape and disposition of the legs enables swift running in confined spaces where flight is impossible.
- vi) Since they are omnivorous, they survive on a wide variety of food materials.
- vii) Their nocturnal emergence renders them less liable to capture.
- viii) Sensitivity of anal cerci to air, movements in crevices ensures a considerable measure of safety for the eggs, with this further protection of the tough oothecal coat.
- ix) They have spines on their legs for defence.

**NB:**

Other insects belonging to the order Dictyoptera include locusts, crickets, praying mantis and grass hoppers etc.

**External features:**

The adult cockroach is about 4cm long.

It is dorsal- ventrally flattened body with brown colour.

It has a hard thick exoskeleton made of chitin.

The body is made up of three main divisions, each segment of thorax and abdomen consists of dorsal plate tegmen (plu:-terga) a ventral plate, sternum (plu-sterna) and two internal plates, pleura.

**Dorsal view**

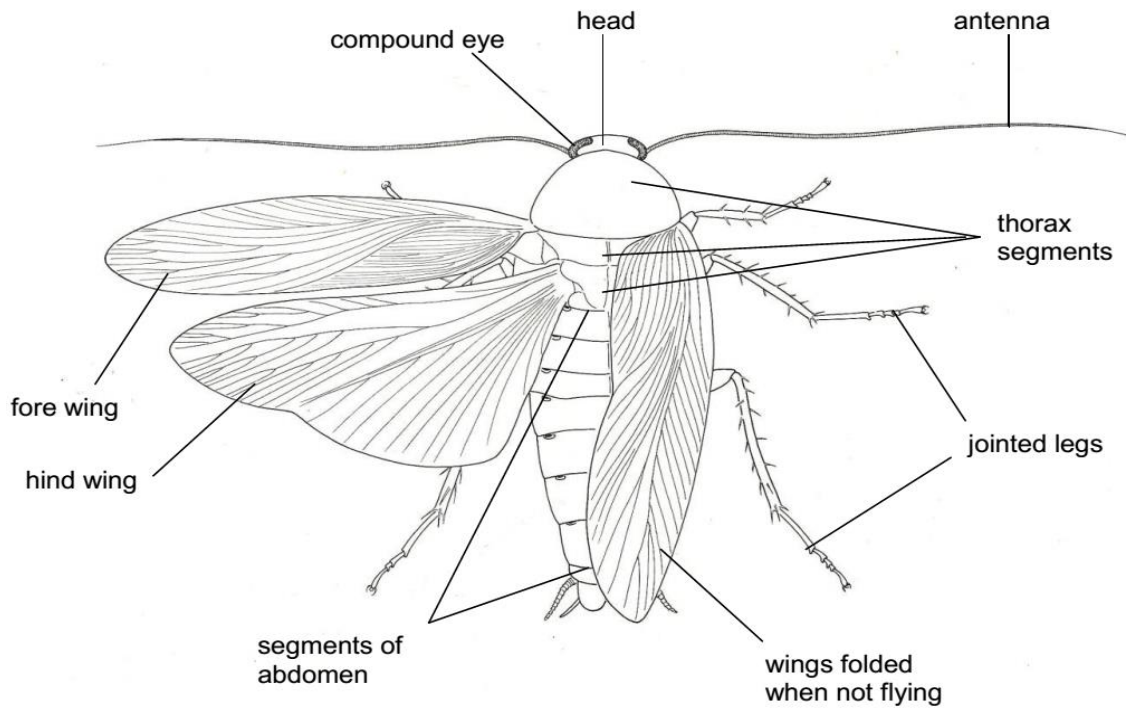

### The head

- ❖ The head is small and pear-shaped.
- ❖ It bears a large kidney- shaped pair of compound eyes.
- ❖ In front of each compound eye lies a long thread- like segmented antennae (feelers). These are sensitive to touch, smell and vibrations.
- ❖ The head has biting and chewing mouth parts – mandibles for cutting and crushing food, maxillary palps for holding food, a labrum (upper lip) and labium (lower lip).
- ❖ The head is connected to the thorax by short neck.

### Mouth parts of a cockroach

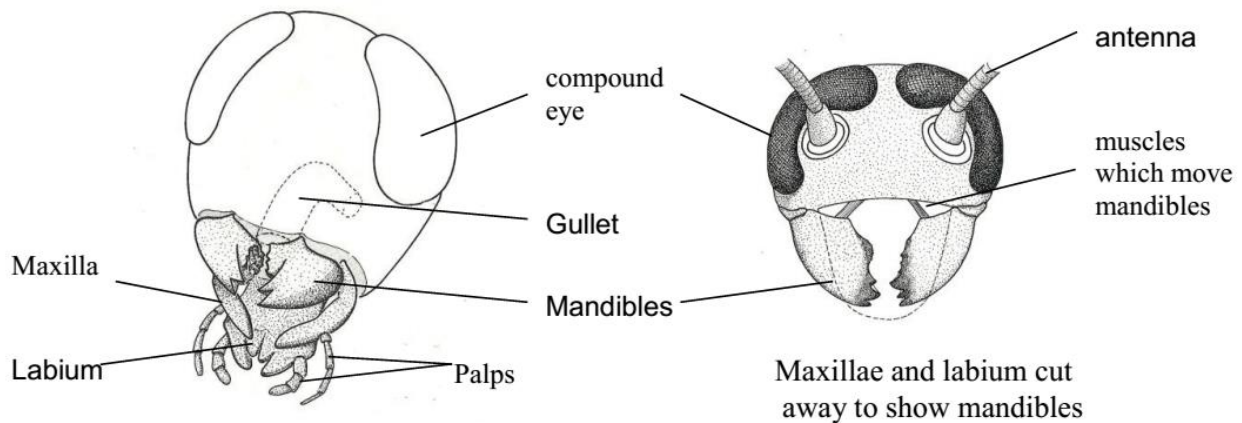

### The thorax

- ❖ The thorax consists of three segments: the prothorax, the mesothorax and the metathorax.
- ❖ Each of the segments bears a pair of jointed legs on its ventral surface. They end in a pair of sharp claws with a soft hairy pad, the arolium (plural: arolia) between them
- ❖ The prothorax is the largest of the thoracic segment
- ❖ The paired wings are attached to dorsal surface of mesothorax and metathorax.
- ❖ The anterior (fore) wings are narrow, brown leathery and still and are called elytra or tegmina. They are not used for flight but for covering and protection of broad, membranous posterior (hind) wings when at rest.

### The fore wing

### The hind wing

### The hind leg

#### Structure of the hind leg

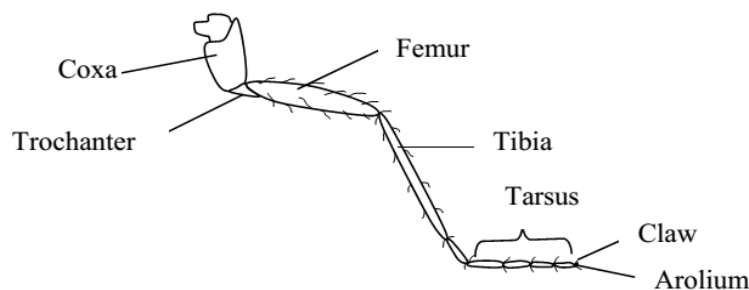

#### The abdomen

This is made up of 10 segments. Only seven are easily seen because tergum of seventh segment covers 8<sup>th</sup> and 9<sup>th</sup> segment

The flat, broad tergum of the 10<sup>th</sup> segment bears a pair of jointed sensory structures, the cerci in males, another additional pair of short structures styles.

There are 10 pairs of oval openings called spiracles at the side of the body, 2 on thorax and 8 in abdominal segment

### Identification of a cockroach's sex

In males, there is a pair of slender **styles** that are used to hold and manipulate the female during copulation.

In females, there is a pair of boat shaped structures called the **podical plates** used for holding eggs.

### Differences between a male and female cockroach:

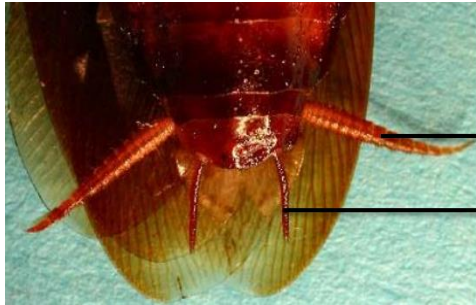
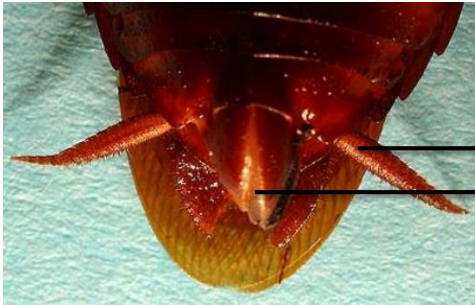
Male	Female
1. Has a narrow abdomen	Has a broader abdomen
2. Lack ootheca	Has ootheca which develops after fertilization.
3. Has rod-shaped structures called styles on the 9 <sup>th</sup> abdominal segments.	No styles on the 9 <sup>th</sup> abdominal segment.
4. No podical plates.	Has podical plate for carrying eggs.
Drawing:	Drawing:
 <p>Cerci</p> <p>Style</p>	 <p>Cerci</p> <p>Podical plate</p>

### The life cycle of a cockroach

A cockroach undergoes incomplete metamorphosis.

After mating, the fertilized eggs are stored in an egg-case called ootheca.

This is hard, chitinous structure 1cm long containing eggs in rows of eight

The female carries ootheca for a number of days before depositing them in dark obscure places. Within a week, it turns dark brown.

After six weeks, the eggs hatch out into young, wingless and colorless cockroaches called nymphs. After 2 weeks they turn brown like adult but wingless.

The nymph grows and undergoes ecdysis, about 7 times and every two ecdysis, the nymphs are called instars. After the last ecdysis, the nymph becomes adult cockroach which has a life span of about 2 months.

### Economic importance of cockroaches

- i) They destroy clothes, books, shoes, furniture and spoil food.

- ii) They spread disease causing germs such as cholera, dysentery etc. especially those in latrines
- iii) They contaminate food if not properly covered.
- iv) They dirty places with their faeces as they move around especially when many.
- v) They are food to some organisms like birds.
- vi) They are used in biological studies as specimens.

### **Control of cockroaches**

- i) Improve personal and public hygiene.
- ii) Use of environmentally friendly insecticides like doom, etc.
- iii) Use of biological control methods.
- iv) Polish the walls of the house to close the small crevices.

## **THE GRASSHOPPER**

### **Classification:**

Kingdom; Animalia

Phylum; Arthropoda

Class; Insecta

Order; Orthoptera

### **Characteristics**

1. They have well developed mandibles for feeding on solid food.
2. They have a pair of long antennae.
3. They have two pairs of straight wings.
4. They have a pair of compound eyes.
5. Females have an ovipositor for depositing eggs in the soil.

### **Life cycle of a grasshopper**

*The grasshopper undergoes incomplete metamorphosis.*

After mating, the females lay eggs in a warm moist sand following rain. It pushes its ovipositor and part of the abdomen down into the sand and makes a burrow where it deposits its eggs. In 10-20 days depending on temperature and moisture

the eggs hatch into adult-like nymphs, which make their way to the surface. As the nymphs grow, they shed their cuticle 5 times. The stage between each moult is called an instar. Each instar lasts for 4-5 days except for the 5<sup>th</sup> instar, which lasts for 8 days. The nymphs feed on leaves and stems of vegetation. After the 5<sup>th</sup> instar, the nymphs change into adults. The adults become mature after five weeks and start laying eggs and the cycle repeats.

### **Economic importance of grasshoppers**

1. They are eaten as food.
2. They are a delicacy to many cultures.
3. They feed on vegetation and act as pests.
4. They are used for study purposes.

### **THE HOUSE FLY** *(Musca domestica)*

#### **Classification**

Kingdom : Animalia  
Phylum : Arthropoda  
Class : Insecta  
Order : Diptera  
Family : Muscidae  
Genus : Musca  
Species : *domestica*

Scientific name is *Musca domestica*.

#### **Characteristics of order Diptera**

- ✓ They have a pair of wings
- ✓ the second pair of wings (hind wings) form halteres or balancers
- ✓ Antennae are short
- ✓ mouth parts are either suctorial and sometimes piercing too
- ✓ the cerci are too reduced or absent
- ✓ metamorphosis is complete
- ✓ many are important vectors

Examples of members in the order include mosquitoes, housefly, tsetse fly etc

## Habitat

House flies live in filthy or dirty places such as toilets, dust bins, manure heaps, e.t.c.

## External features

The body of the housefly is divided into three main parts, head, thorax and abdomen.

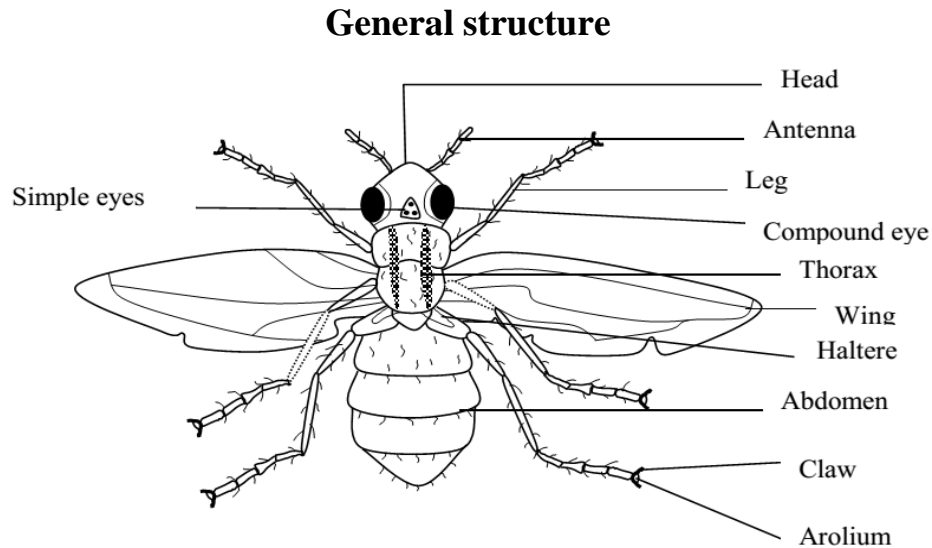

## The head

- ❖ The head bears three simple eyes (ocelli) arranged in triangle and on each side is a large or prominent compound eye.
- ❖ The antennae are short with three joints with last having spine hair.
- ❖ The labium (upper lip) is modified into proboscis for sucking, which is expanded at the distal end to form a funnel shape.

## Structure

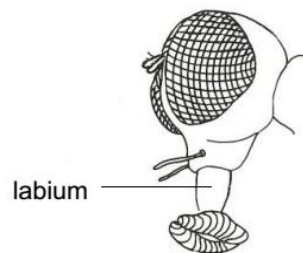

## Life cycle of a housefly

*The housefly undergoes complete metamorphosis.*

After mating, the female housefly lays eggs in batches. The eggs are laid on rotting matter such as meat or faeces, where it is warm and moist. This provides the conditions for the eggs to develop.

After about 8-24 hours, the eggs hatch into larvae. The larvae (maggots) are white and conical shaped. The maggot has a small head which is not easily visible. The head bears a mouth with two hook-like teeth. These are used for feeding on decaying matter in which the larva finds itself. The hook-like teeth also helps the larva move through the decaying matter. The larva has no legs but has pads with short spines that help in movement. Spiracles are present only on the 2<sup>nd</sup> and the last segment. They are used for breathing. The larva has no eyes but sensitive to light. It prefers dark, moist, and warmer regions of the decaying matter. It grows by shedding its outer layer (cuticle).

After 5 days and shedding its cuticle twice, the larva is about 1cm long. It then moves to a drier region of the meat or faeces and pupates.

The puparium is cigar shaped. The cuticle hardens, darkens and becomes brown to form the puparium or pupa case. This forms a protective covering as internal reorganization of tissues takes place inside.

After the puparium bursts open, the adult fly emerges.

The wings expand and harden and after a few hours, the fly flies away.

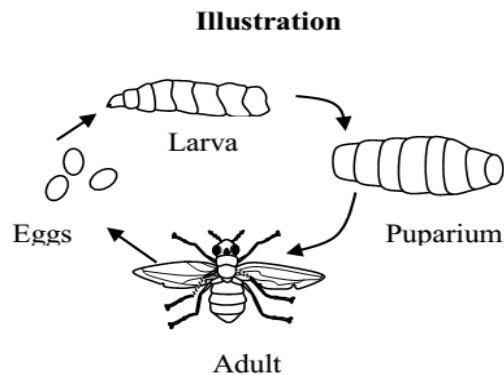

### **Economic importance of house flies**

- i) They feed on faeces and manure heaps, hence help in garbage disposal.
- ii) They are vectors of diseases i.e. spread or transmit diseases such as dysentery, cholera, red eyes, trachoma, etc.
- iii) It is a source of food for some organisms such as chameleons.
- iv) They are specimens for study purposes.

### **Control of house flies and prevention of diseases they spread**

- i) Spraying with an insecticide such as pyrethrum to kill the adult.

- ii) Proper disposal of faeces in latrines with covers, so that flies cannot get to the waste to lay eggs.
- iii) Washing hands with soap and clean water after visiting the latrine and before eating or preparing food.
- iv) Disposing of wastes in such a way that flies cannot reach them. E.g. burning or burying them.
- v) Covering or storing food properly so that flies cannot settle on it.

## **THE MOSQUITO**

The mosquitoes are majorly found in the tropics and are best known for carrying disease germs

They belong to the order Diptera and the important three genera are:

1. Anopheles that are vectors of malaria
2. Culex which are vectors of dengue fever and
3. Aedes, the vector of elephantiasis and yellow fever.

### **Classification**

Kingdom : Animalia  
Phylum : Arthropoda  
Class : Insecta  
Order : Diptera  
Family : Culicidae  
Genus : Anopheles  
Species : *Anopheles, Aedes and Culex*

### **Structure of mosquito**

Mosquitoes are slender, long-legged insects and like all other Dipterans, they have proboscis, a pair of wings and a pair of halteres.

Male mouth parts are for sucking but the female mouth parts are for piercing and sucking.

When the female mosquito bites someone, she pierces the skin with the stylets and inserts the sucking and salivary tubes. Saliva is secreted into the wound and prevents the blood from clotting and blocking the tubes mean while the labium bends back.

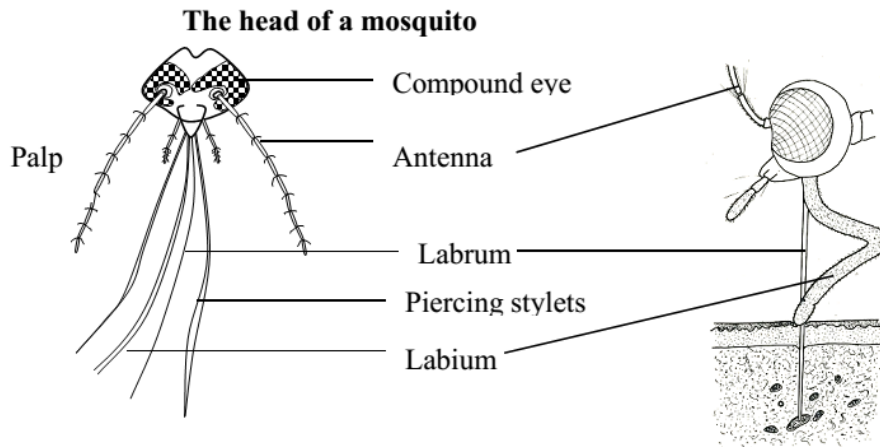

When the female bites, it pierces the skin with the stylets and inserts the sucking and salivary tubes. Saliva is secreted into the wound to prevent the blood from clotting and blocking the tube. The mosquito then sucks blood from which it obtains its nutrients.

### **Features on the thorax**

- ✓ The thorax is large and easily visible.
- ✓ It has the usual three segments bearing a pair of long slender legs.
- ✓ The mesothorax bears a pair of membranous, transparent wings while the metathorax bears a pair of halteres used in balancing and also sensory in function.
- ✓ Has a pair of spiracles on each segment.

### **Features on the abdomen**

- ✓ The abdomen is long and slender.
- ✓ It has 10 segments but only 8 are seen.
- ✓ It has a pair of spiracles on each segment.
- ✓ The last segment bears the external genitalia

### **Mode of life of a mosquito**

- ✓ Hates light and like resting in dark places during day and comes out to feed at night
- ✓ They feed mainly within late evening and early morning (day and dawn)
- ✓ Male mosquitoes feed on plant juices and nectar while the female feed on blood.

### **Life cycle of a Mosquito**

It begins with mating and internal fertilization and is a complete metamorphosis. The difference however are observed for both Anopheles and Culex mosquitoes

Mosquitoes eggs are laid in still water (swampy pools, water collected in old pots/ tins, in axils of leaves, blocked drains or gutters), and the earliest stages of life take place in water.

The eggs are boat shaped and those of *Culex* species stick together to form raft. Those of *Anopheles* are laid singly each with air float.

The larva consists of a head, thorax and abdomen. It swims through water, tail first by wriggling its abdomen. *Culex* larva uses Siphons for obtaining oxygen whereas *Anopheles* uses spiracles, located on the eighth abdominal segment on both types of larva.

The pupa differs from the larva in being fairly active. It is comma-shaped with two tail fins at the end of the abdomen. It breathes atmospheric oxygen through a pair of trumpets on the thorax.

After few days the pupa skin splits and adult emerges. It rests on pupa case while the wings unfold and harden and then flies away.

### The life cycle of mosquito

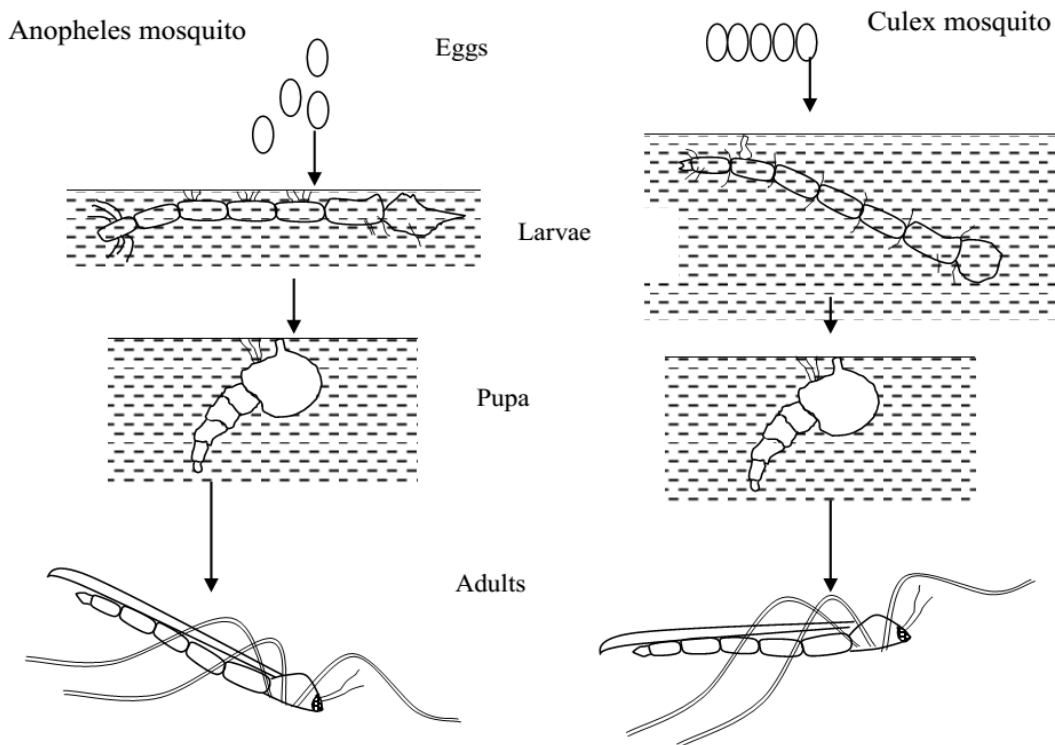

### Economic importance of mosquitoes

They carry malarial parasites which cause malaria. These germs are carried by a female anopheles. The disease causing parasite is referred to as *plasmodium*. The four types of plasmodia are;

1. *Plasmodium malariae*
2. *Plasmodium vivax*
3. *Plasmodium ovale*
4. *Plasmodium falciparum*

### **Symptoms of malaria**

- ✓ A Person with malaria has very high fever.
- ✓ Headaches.
- ✓ Sometimes vomiting.
- ✓ Pain in the joints and sometimes the general body.
- ✓ There is alternate cold and shivering spells as well as hot sweating.
- ✓ Loss of appetite.
- ✓ Anemia.
- ✓ Enlarged liver and spleen.

Malaria may cause convulsions and sometimes death in children and abortions in pregnant women due to destruction of red blood cells by the parasites.

### **Control of spread of malaria**

Of these diseases malaria is probably becoming the most serious and is increasingly becoming a killer of such great as AIDS. This is mainly because the parasites causing it are becoming resistant to drugs like chloroquine which in the past have been very effective at old malaria.

As things stand now, effective control of the mosquito is as much prerequisite to control malaria as it is to combat the disease.

#### **Appropriate measures include;**

- ✓ Destroying the breeding places where larvae develop from by draining or applying a film of oil over the water surface to prevent oxygen reaching the mosquito larva.
- ✓ Burning or burying all empty containers to prevent water from collecting during the rainy season.
- ✓ Clearing bushes around homestead. Mosquitoes like to rest and breed on them during the rainy season.
- ✓ Biological control which involves the introduction of fish into water bodies which feed on the larvae and pupa.
- ✓ Mosquitoes can be killed by spraying with insecticides using special sprayers.
- ✓ Removal of small water containers such as old tins, bottles, and drainage channels, so as to reduce on breeding sites.

- ✓ protecting our bodies from mosquito bites by using mosquito nets at night as well as wearing clothes which cover both legs and arms in the evening
- ✓ Parasites development in the human body can be controlled by taking modern prophylactic drugs regularly.
- ✓ Applying mosquito repellent cream to the body.

*Aedes species carry a virus which causes Dengue. It also carries germs which cause yellow fever.*

*The Culex species carry filarial worms which cause elephantiasis. It is not a killing disease but causes discomfort due to large swelling of the legs and/ arm.*

### Differences between

Anopheles	Culex
i) Eggs are laid singly	Eggs are in rafts
ii) Eggs have air floats to keep buoyant	Eggs have air float
iii) Eggs are boat shaped	Eggs are cigar shapes
iv) Larva lies parallel to the water surface	Lies at an angle to the water surface
v) Larva has a pair of spiracles for breathing	Larva has siphon for breathing
vi) Adult at rest lies at an angle to the object	At rest lies parallel to the object

## THE HONEY BEE

*(Apis mellifera)*

### Classification

Kingdom : Animalia  
 Phylum : Arthropoda  
 Class : Insecta  
 Family : Hymenoptera  
 Order : Hymenoptera  
 Genus : Apis  
 Species : *Apis mellifera*

### Characteristics of order hymenoptera

- ✓ Insects are social in behaviour.
- ✓ Parthenogenesis is complete
- ✓ After castes present are queens, drones, workers and soldiers
- ✓ Mouth parts modified for biting and sucking

- ✓ Metamorphosis is complete
- ✓ Antennae are short

Examples include bee swarms, ants, gall wasps

Generally, bees are social insects and live in colonies (large numbers) in bee hives. They show division of labor among the castes for instance;

**The queen** produces other bees.

**The drone** fertilizes the queen.

**The workers** have a number of duties among which include collecting food and cleaning the hive.

### **External features on the honey bee especially worker include:**

- ✓ The head is not fixed on the thorax and therefore it is free to move (mobile).
- ✓ The compound eyes are prominent. In addition to these are simple eyes which are three in number.
- ✓ The antennae are short and segmented.
- ✓ The mouth parts are a modified proboscis which is curved at the distal end. It is used for lapping during feeding and also used for construction, the glossa also modified for sucking.

The features on the thorax include pairs of legs which differ in various aspects as shown below.

#### **The fore leg**

The fore leg has a pollen comb located at the end of the tibia. This is used for cleaning pollen off the head.

#### **The middle leg**

These legs possess a hair like structure, prong at the distal end of the tibia. The prong is used for scooping pollen grains out of the pollen basket on the hind leg.

## Hind leg

The leg is hairy with pollen baskets, which are responsible for carrying pollen grains.

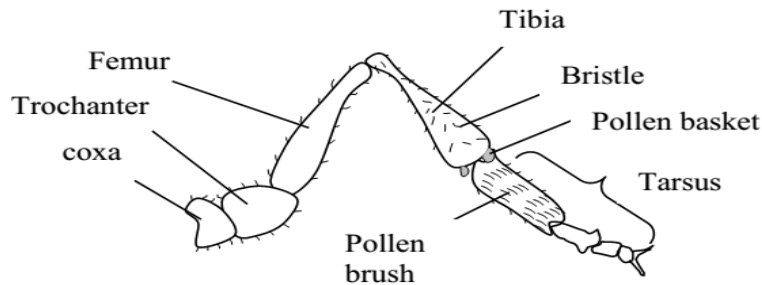

These have pollen baskets on their tibia which are used for carrying the collected pollen grain to the hive. They also possess tufts of hairs on the tarsus called **pollen brush** which are used for cleaning pollen off the body into the basket on the other leg.

### Wings:

There are two pairs of membranous and transparent wings. The hind wings are smaller than the fore wings and are interlocked with the latter by means of hooks.

### Abdomen:

Features on the abdomen include the first abdominal segment usually being fused with the metathoracic segments. The last segment of abdomen has the stinging device. They have flexible segments which allow the bee to bend, stretch, and expand during breathing and stinging.

The abdomen has six segments four of which contain wax glands.

### 1. The Worker bees:

These are sterile females. They occur in large numbers within the colony. They perform most of the work in the hive and that is why they are called workers.

The roles of workers include;

- ✓ They collect food for other bees in the hive.
- ✓ They guard the hive and protect other bees.
- ✓ They protect the hive.

## 2. The drone bees:

These are male bees. They are larger than workers and are usually very few in the hive. Their role is to fertilize the queen after which they are stung to death by workers.

## 3. The queen.

This is the fertile female bee. It is usually one in the hive. Its work is to produce all the other bees in the hive.

### Life cycle of a bee

Like a butterfly, a bee undergoes complete metamorphosis and differs in length after the larva stage depending on what the larva is fed on. Therefore food will determine the caste to be developed. This is summarized below

#### Workers take 21 days

Egg → Larva → Pupa → Adult  
3 days                      6 days                      12 days

The larva here is fed on bees' milk (royal jelly) for 3 days followed by a mixture of honey and pollen.

#### Queen takes 16 days

Egg → Larva → Pupa → Adult  
3 days                      6 days                      7 days

Here the larva is fed on royal jelly for 3 days and after on a mixture of pollen grain. Generally the queen bee is the only female in the bee hive and therefore the only capable one to lay eggs.

Also it is the largest caste, each bee hive has only one queen. She mates only once in her life time with only one drone. The eggs produced are of two types, both fertilized and unfertilized.

The fertilized one develops into queens and workers while unfertilized ones develop into drones. Note that in fertilized eggs, the type of food fed to the larva determines whether the caste will be queen or worker.

The queen does not do any work in the bee hive. It is fed and nursed by the workers. It has a sting she uses to kill other developing queens so as to remain the only queen in the hive.

The old queen leaves the hive just before the new queen hatches from the pupa and goes away from the hive with a few drones in a swarm.

The drones are the only male bees in a hive. They result from unfertilized eggs of the queen. Only one of the drones and queen go out on a nuptial flight, like the queen, the drone does not do any work in the hive. They are fed by the workers. But in case of food shortage, some of them are killed by workers i.e. stung to death.

The workers on their side do not lay eggs because they are infertile females. They are the smallest in size among the bees but are the most humorous in the hive. They perform the following duties among others.

- i) Cleaning the bee hive by eating away dirt and rubbish.
- ii) Feeding the old grubs (larva) on honey and pollen.
- iii) Packing and storing honey and pollen in the cells of the honey comb.
- iv) Feeding the young grubs on their milk produced by their own salivary glands.
- v) Producing wax from their wax glands.
- vi) Field work to collect food and pollen.
- vii) Guarding the bee hive against any enemies.

### **NB**

The wax produced is used for building the honey combs in which the honey is stored and eggs are laid.

The wax is usually formed of sweat after they have eaten too much honey.

### **Economic importance of bees**

- ✓ Source of honey which is a rich food (carbohydrate)
- ✓ Pollinate plants most of which provide food for man.
- ✓ Provide wax used in industry to make candles, varnish, shoe polish etc.
- ✓ Their honey is a drug for many diseases like cough.
- ✓ They are useful specimen for biological studies.
- ✓ The worker bees stings inflict irritation on our bodies.

### **WHY INSECTS ARE BIOLOGICALLY SUCCESSFUL**

Insects are mainly terrestrial arthropods that have specialized features and behaviours. These features have enabled the insects to live almost in any part of the world. There are approximately 70,000 different species of insects.

1. Insects have a high rate of fertility and reproduction. They lay many eggs at once such that when some are destroyed, many survive and develop into adults.

They increase in number very rapidly because their life cycles are short. i.e. they take few months or days.

2. Their bodies are covered with waxy cuticle made of chitin which does not allow water to pass through hence reducing dehydration of insects in different environments.
3. Insects have a wide range of modification in their mouth parts that are adapted to feeding on different foods. E.g. the adult butterflies feed on nectar while the caterpillars feed on plant leaves. This reduces competition for food.
4. Some insects have developed wings for flying and all have legs for walking, thus enables the insects to disperse successfully, easily escape from enemies (predators) and as a means of looking for food.
5. Possession of exoskeleton and some have fore wings hardened to provide mechanical support.
6. Majority are small in size. Hence they take in little food, occupy small space and escape easily from enemies. Others have variable shapes to fit their mode of life in the locality they live in e.g. cock roaches' body is dorsal-ventrally flattened for easy passage in narrow path ways (crevices).
7. Some insects have a variety of colours for camouflage and some spots that have false aggressive and warning appearance to predators e.g. false eyes on the wings of butterflies.

## **PHYLUM: CHORDATA**

Chordate refers to animals which possess a notochord.

### **Main characteristics**

- ✓ The presence of a notochord during the early stages of development.
- ✓ They have bilateral symmetry.
- ✓ The body is composed of head, trunk and usually a tail at some stage of development.
- ✓ Possess a hollow dorsal nerve cord.
- ✓ They have pharyngeal clefts.
- ✓ They limbs originate from different body segments.

This phylum mainly consists of the vertebrates and they are divided into 5 classes.

The 5 classes include the following;

1. **Pisces** (fishes) e.g. tilapia and the Nile perch,
2. **Amphibia**, e.g. frogs and toads
3. **Reptilia** e.g. snakes, lizards, crocodiles
4. **Aves** - birds
5. **Mammalia** e.g. man and whale

## CLASS: PISCES

This class contains fish.

### Characteristics of organisms in class Pisces

- ✓ They live in water
- ✓ They have a streamlined body
- ✓ They scales on their skin
- ✓ They breathe using gills
- ✓ They have fins for swimming.
- ✓ They have eggs that are fertilized outside the body (externally)
- ✓ They are ectothermic – they rely on external conditions to maintain their body temperature.

The fish is further sub divided into two sub classes, namely chondrichthyes and osteichthyes.

### Sub class: chondrichthyes

Chondrichthyes are also referred to as Elasmobranches. These are cartilaginous fish. They include sharks, rays, dogfish and skates.

### Subclass: Osteichthyes

Osteichthyes are also known as teleosts. Teleosts are bony fish.

Examples of bony fishes include tilapia and herring.

The figure below shows a tilapia fish

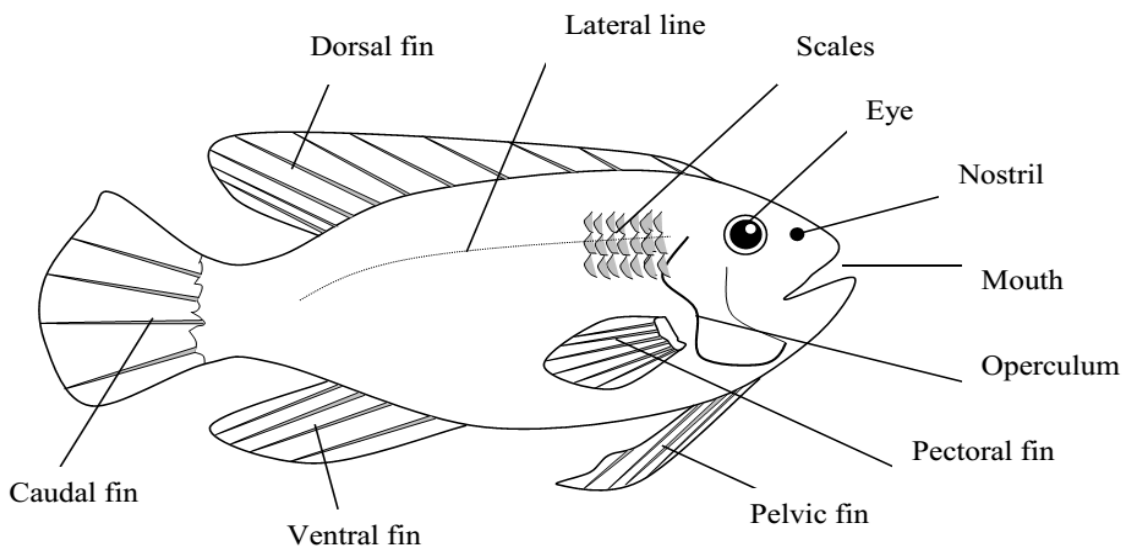

### Differences between bony and cartilaginous fish

Bony fish	Cartilaginous fish
Have a bony skeleton	Have a cartilaginous skeleton
Have smooth, overlapping, round-shaped scales	Have scales that are not round shaped-rough skin.
Have opercula (gill covers) covering their gills.	Have no opercula, but have gill slits.
Have homocercal tails ( in 2 equal parts)	Have heterocercal tails (in 2 parts of unequal size)
Swim forwards and back wards	Can only swim forwards
Have a gas-filled swim bladder that controls buoyancy.	Have no swim bladder

### CLASS: AMPHIBIA

This class includes the newt, salamander, toad and frog. The word amphibian comes from two greek words: amphi- (both) and bios (life). This means that amphibians spend part of their life (as larvae or tadpoles) in water, and part of their life as adults on land. Amphibians live on land but require water for breeding.

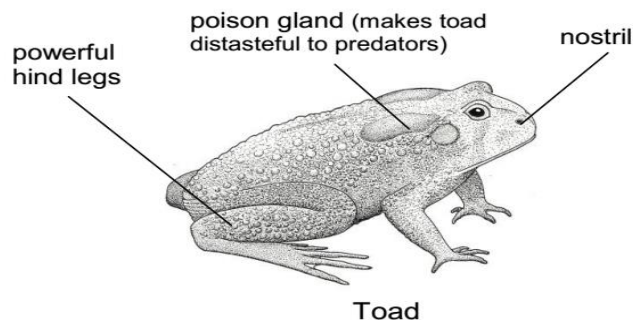

### Distinguishing characteristics

- ✓ Amphibians have a soft moist skin without scales.
- ✓ They have a bony skeleton.
- ✓ They have two pairs of pentadactyl limbs. A pentadactyl is one which has five digits
- ✓ They have visceral clefts at the larval stages which are used as gills for gaseous exchange. Adult amphibians use lungs for gaseous exchange.
- ✓ Amphibians have middle and an inner ear but no external ear. However, they have a tympanic membrane also called the ear drum
- ✓ The egg of amphibians are laid in water and fertilized externally.

- ✓ An amphibian has a three-chambered heart with two auricles and a ventricle.
- ✓ They are poikilothermic / ectothermic.

### **CLASS: REPTILIA**

Reptiles are mainly terrestrial with the exception of the turtle which lives in water. Examples of reptiles include the lizard, snake, crocodile, tortoise and turtle.

#### **Distinguishing characteristics**

- ✓ Reptiles have dry skin with horny scales
- ✓ Their skeleton is made up of bones
- ✓ Most reptiles have pentadactyl limbs
- ✓ Some reptiles have a middle and inner ear. Snakes have no middle ear.
- ✓ Reptiles do not have an external ear.
- ✓ They use lungs for carrying out gaseous exchange
- ✓ Their eggs are fertilized internally and laid on land. Some snakes give birth to live young ones
- ✓ Some reptiles have a three-chambered heart; two auricles and one ventricle. Others have four chambered heart for example crocodile.
- ✓ Reptiles are poikilothermic.

### **CLASS: AVES**

Aves refer to birds. There exists a wide variety of birds. Examples of birds include eagle, ducks, flamingo, heron, dove etc.

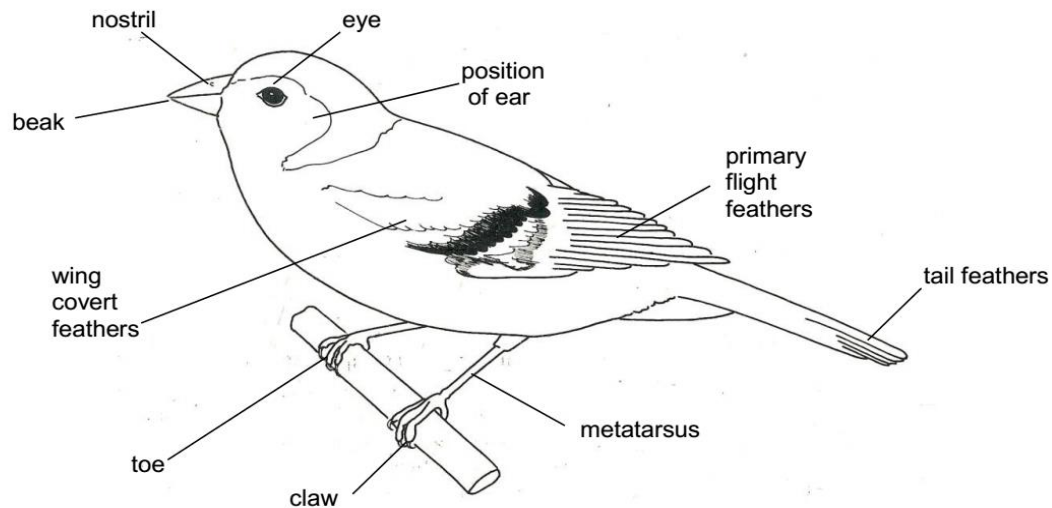

#### **Distinguishing characteristics**

- ✓ The skin of birds is covered by feathers, except the legs which are covered by horny scales. The feathers keep the bird warm and also used for flight.

- ✓ They have skeleton is made of hollow bones. The hollow and light bones reduce weight and enable flight.
- ✓ They have two pairs of pentadactyl limbs. The fore limbs modified into wings for flight while the hind are feet for walking or swimming.
- ✓ They have middle and inner ear but no external one. However, they have tympanic membrane.
- ✓ They use lungs for gaseous exchange.
- ✓ They have beak for feeding.
- ✓ They have internal fertilization. They lay eggs in calcareous shells.
- ✓ Their hearts have four chambers.
- ✓ They are ectothermic.
- ✓ They show parental care.

### **CLASS: MAMMALIA**

Mammals comprise a wide variety of animals. They mostly occupy terrestrial habitats except few which occupy aquatic habitats. Examples of terrestrial mammals are cows pigs, goats, monkeys, rats, lions etc. and the aquatic mammals are seals, dolphins and whales.

#### **Distinguishing characteristics**

- ✓ The skins of mammals are covered by hairs or fur.
- ✓ The skin has sweat glands called sebaceous glands.
- ✓ They have an endoskeleton made up of bones.
- ✓ They use lungs for breathing or gaseous exchange.
- ✓ They have two pairs of pentadactyl limbs.
- ✓ They have an external, middle and inner ear.
- ✓ They have four types of teeth for feeding.
- ✓ They have four chambered heart.
- ✓ They have muscular diaphragm which separates the thoracic organs from the abdominal organs.
- ✓ Their brains are well developed thus intelligent.
- ✓ They are homoeothermic.
- ✓ They have internal fertilization.
- ✓ They have mammary glands.
- ✓ Give birth to live young ones except the platypus.

#### **Class Mammalia is divided into 3 sub classes;**

##### 1. Monotrema

These are the egg laying mammals. They include the spiny anti eaters, and the duck billed platypus.

##### 2. Metatheria

These are the marsupials which keep their immature young ones in the pouch where they continue to grow. They include the Kangaroos, Wallaby, Koala bear, etc.

### 3. Eutheria

They have placenta. They give birth to fully developed young ones and suckle the mammary glands. They include man, rats, cows, goats, etc.

## **KINGDOM: PLANTAE**

The kingdom Plantae comprises a variety of plants.

### **General characteristics**

- ✓ They are mostly green in colour thus carry out photosynthesis
- ✓ They are multicellular.
- ✓ They exhibit; limited movements such as opening and closing of petals etc.
- ✓ Their cells are surrounded by cellulose cell wall.
- ✓ They respond slowly to external stimuli and do not move from one place to another.

The kingdom is sub divided into three divisions, Bryophyta, Pteridophyta, spermatophyta and the algae.

## **ALGAE**

They include;

1. Green algae(chlorophyta) e.g. spirogyra and chlamydomonas
2. Brown algae(phycochyta) e.g focus and laminaria
3. Red algae(rhodophyta)e.g chondrus

### **Characteristics of algae**

- ✓ Commonly found in fresh and marine water.
- ✓ They are single-celled, colonial or filamentous.
- ✓ They are autotrophs.
- ✓ They have wide range of pigments, liked brown, green, blue, red and yellow.
- ✓ They have a thallus body which is not differentiated into leaves, item or roots
- ✓ They are non-vascular organisms.
- ✓ They reproduce asexually by fragmentation and binary fission. Few algae reproduce sexually by conjugation.

### **Spirogyra**

## Characteristics of spirogyra

- ✓ It is filamentous green algae found in fresh water of slow flowing water in ponds, streams, and lakes
- ✓ It grows in length and its always one cell thick.
- ✓ Each cell is capable of living an independent life
- ✓ Each cell has one spiral chloroplast from one end to another
- ✓ Small protein bodies called pyrenoids are present on each ribbon like chloroplast and are used to store starch
- ✓ The nucleus is in the center to control the activities of the cell
- ✓ There is a gelatinous sheath(mucilage) around the cells that gives them slimy nature that is useful for protection

## Reproduction in Spirogyra

### 1. Asexual reproduction

The vegetative reproduction is common and consists of part of the filament breaking off and continuing to live as a separate plant. It can also be called fragmentation.

### 2. Sexual reproduction

Spirogyra reproduces by conjugation between filaments lying side by side as follows;

- The opposite cells of the two different filaments lying side by side develop a swelling or an out-growth which begins to grow towards each other.
- On touching they dissolve to form a conjugation tube and at the same time the contents change into gametes.
- The gametes from one cell (male gamete) migrate through the conjugation tube to another cell (female) gamete.
- The two gametes fuse to form a zygote which develops a thick resistant wall and becomes a zygospore.
- When the conditions are favorable, the zygospore germinates and grows into another filament.

### Illustration

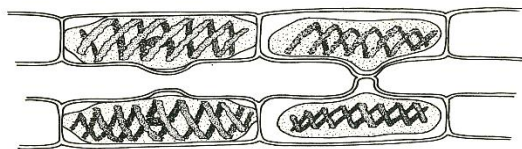

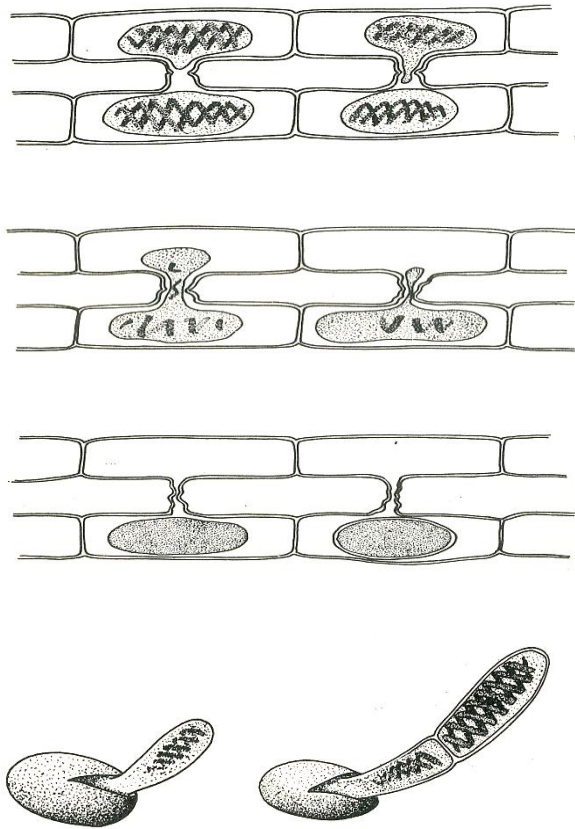

### **Economic importance**

- ✓ Algae are used in the manufacture of gar
- ✓ They provide food for humans and fish.
- ✓ When they die, they sink at the bottom of the sea bed on which they can turn into oil.
- ✓ During photosynthesis, they release oxygen that is necessary for the respiration of animals that live in water.
- ✓ They are used in the manufacture ice cream, cosmetics, and plants.
- ✓ They pollute water, i.e. producing foul smell.
- ✓ They clog water pipes in hindering the flow of water

### **DIVISION: BRYOPHYTA**

The division is comprised of liverworts and moss plants.

#### **Main characteristics**

- ✓ They have simple leaves and rhizoids that are root-like structures. They are used mainly for anchorage.
- ✓ Plants lack vascular bundles thus depend on diffusion for movement of materials.
- ✓ They are photosynthetic.

- ✓ They are found in sheltered and wet areas.
- ✓ Their life cycle consists of the two generations which alternate a gametophyte and sporophyte generation

Examples are mosses and liverworts which belong to 2 classes; musci and hepatica respectively.

### **DIVISION: TRACHEOPHYTA**

These show alternation of generations. The sporophytes differentiate into roots, stems and leaves with lignified vascular tissues that are used for conducting water and food.

This division is divided into 2 sub-phyla:

1. Pteridophyta
2. Spermatophyta

#### **Pteridophyta**

This is made up of ferns. Ferns are commonly found in shaded places which are damp with cool temperature. Some ferns grow on trees as epiphytes.

The body of a sporophyte fern is divided into leaves, stems and roots. The leaves are called fronds while the stems are rhizomes. The spore forming structures are called sporophyta which occur on the underneath (side) of a frond in clusters called sori.

#### **Main characteristics**

- ✓ The sporophyte is the dominant generation while gametophyte generation is short lived.
- ✓ The rhizomes grow horizontally below the soil surface.
- ✓ Ferns have well-delivered conducting tissues i.e. vascular bundles. The xylem also supports the plants.
- ✓ They have the adventitious roots which anchor the plants into the soil and absorb materials.

### **DIVISION: SPERMATOPHYTA**

The spermatophyta comprises of well-developed plants which are adapted to a variety of habitats. The habitats include terrestrial and aquatic. The seed are either contained inside the ovary wall or exposed.

#### **General characteristics**

- ✓ The body is divided into leaves, stem and root system
- ✓ Plants have complex and well developed vascular tissues.

- ✓ The supporting tissues like xylem, sclerenchyma and collenchyma, are found in leaves, stem and roots. Turgid parenchyma cells also provide support.
- ✓ Reproduce sexually.
- ✓ Sporophyte generation is greatly reduced and short-lived( flower)

**The division is subdivided into two sub divisions:**

### **Gymnospermae (cone bearing plants)**

These are commonly found in high lands/ altitudes areas. They show xerophytic characteristics such as sunken stomata, needle-like leaves, thick waxy cuticle to prevent or reduce rate of transpiration.

Examples include pines, cypress, cedar tree, cycads, jacaranda, and bougainvillea.

Gymnospermae refers to plants whose seeds are not enclosed.

### **Main characteristics**

- ✓ They are non-flowering plants.
- ✓ Their seeds are found in the cone scale.
- ✓ Have needle like leaves which reduce the rate of transpiration.
- ✓ Found in high altitudes and can carry out photosynthesis at low temperatures.

### **Angiospermae (flowering plants)**

These are flowering plants where seeds are enclosed in the ovary of the fruits.

### **General characteristics**

- ✓ They are flowering plants
- ✓ Their seeds are enclosed in the ovary from where the fruits develop
- ✓ The reproductive organs are found within the flower

These are sub divided into two classes. Monocotyledonae and dicotyledonae.

### **Monocotyledonae**

These are mainly grass family. Examples include wheat, rice, barley, star grass, sorghum, maize, millet sugarcane etc.

### **Distinguishing characteristics**

- ✓ Seeds have one cotyledon
- ✓ Have fibrous root system
- ✓ Have parallel veins in their leaves
- ✓ Leaves are generally narrow and long.

- ✓ Vascular bundles are scattered in the stem cross section
- ✓ Lack vascular cambium, i.e. no secondary thickening of the stem.
- ✓ Flowers are held on an inflorescence.
- ✓ The floral parts are in threes or multiples of threes.

### **Dicotyledonae**

These include herbs, shrubs and trees. Herbs are non woody plants so turgidity of cells supports them. Shrubs and trees have stems with supporting tissues such as xylem.

Examples include beans, jacaranda, hibiscus, etc.

### **Distinguishing characteristics**

- ✓ Have seeds with two cotyledons
- ✓ They have tap root system.
- ✓ Have network (reticulate) venation.
- ✓ Leaves are generally broad and short.
- ✓ Vascular bundles are radially arranged in the stem cross section.
- ✓ Have vascular cambium for secondary thickening.
- ✓ The floral parts are in fours or fives or in their multiples.

### **Question**

State the differences between monocotyledonous and dicotyledonous plants.

## **FLOWERING PLANTS**

These are plants that bear flowers. A typical flowering plant is composed of 2 systems:

- ❖ Root system
- ❖ Shoot system

The two systems are made up of two categories of organs i.e.

**Reproductive organs:** these produce fruits and seeds. They are directly involved in the reproduction of the plant.

**Vegetative organs:** these are not directly involved in the reproduction. They include roots, stems and leaves.

### **Structure of a flowering plant**

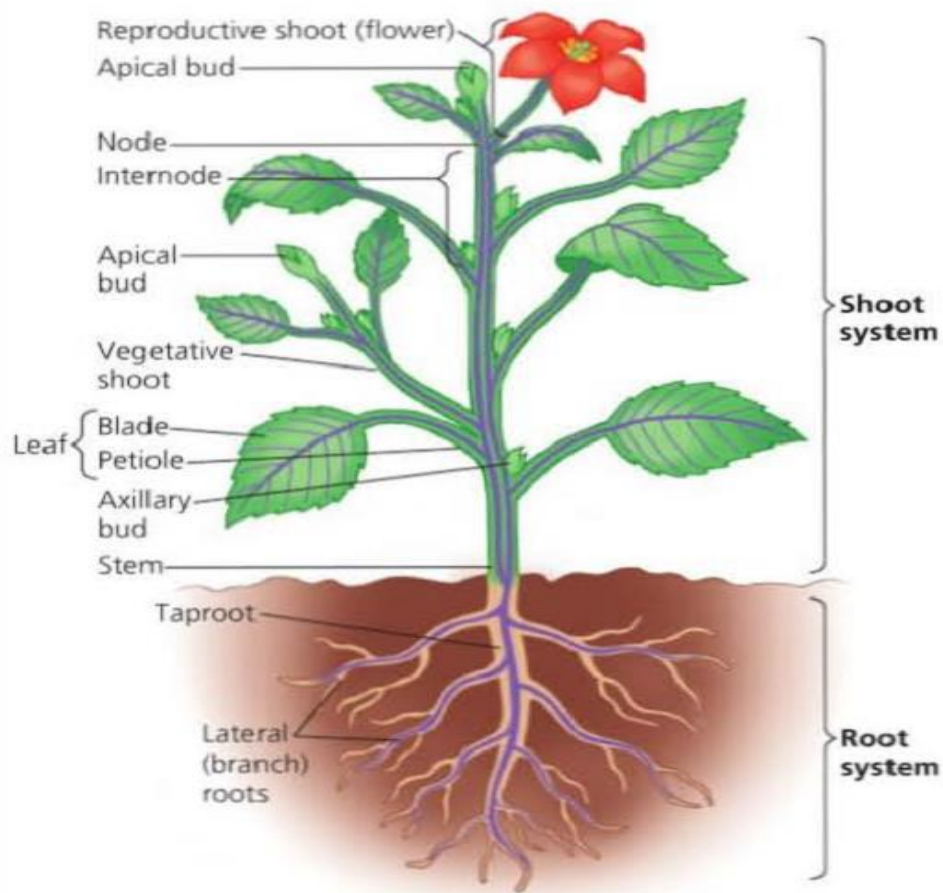

## ROOTS

A root is a descending portion of the axis of the plant and develops from the radical of the embryo during germination.

### KINDS OF ROOTS

There are 3 main kinds of roots;

#### 1. Primary roots

These are the first roots to grow out of a seed as an extension of the radicle.

#### 2. Secondary roots

These grow laterally from the primary roots

#### 3. Adventitious roots

These are roots that grow from the stems or leaves and not as branches from either primary or secondary roots. They are almost of the same size.

## TYPES OF ROOTS

### 1. Tap root system

*This consists of a main root growing straight down wards from the radicle. It gives rise to side roots called lateral roots. Tap root system is a characteristic of dicotyledonous plants.*

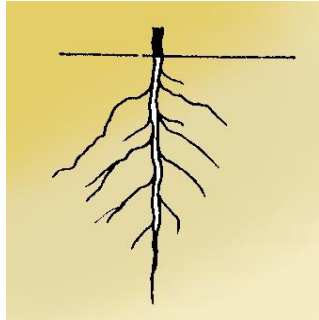

### 2. Fibrous root system

*This is the root system without a main root and all roots arise from the same point of the base of the stem. The roots are almost of the same size and a characteristic of monocotyledonous plants.*

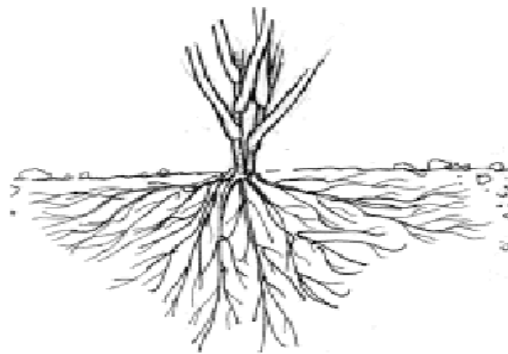

### Functions of roots

- i) They anchor the plant firmly in the soil.
- ii) They absorb water and mineral salts from the ground to the plant.
- iii) They conduct the absorbed water and mineral salts up to the stems and leaves.
- iv) In some plants, roots are modified into root tubers which store food e.g. cassava.
- v) Some roots are modified for breathing e.g. white mangrove.

## MODIFIED ROOTS

### 1. Storage roots

These are thick fleshy and succulent roots. *They contain stored food like sugar and starch. The roots are modified as root tubers e.g. carrots, cassava and sweet potato roots.*

### 2. Breathing roots

These are found on some plants growing in swampy areas e.g. *white mangrove*. Its roots grow up through the mud to the air. The root parts above the mud are spongy and absorb air from the atmosphere. The main root of such plants bears branch roots.

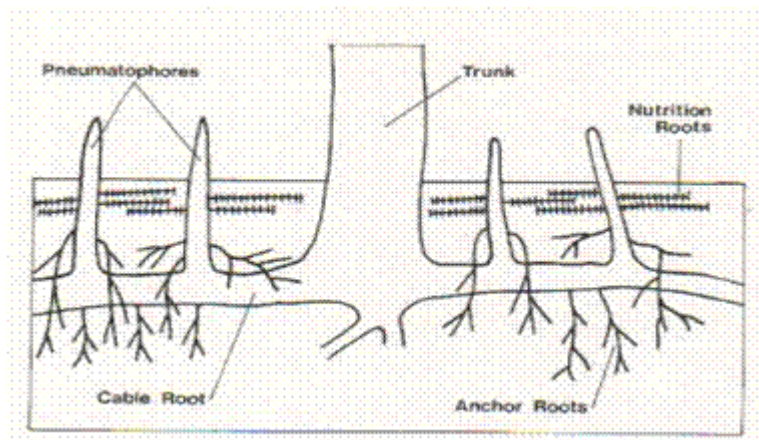

### 3. Stilt roots

These roots develop from the main stem in certain plants such as *red mangrove* which grow in muddy areas. *Stilt roots provide additional support to the plant.*

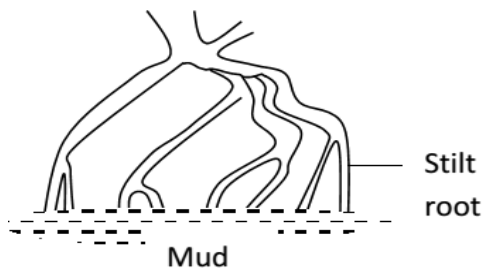

### 4. Prop roots

These are found growing on plants such as *maize, sorghum and sugar canes*. They develop from the nodes of the stem close to the soil surface. ***They provide extra support by holding the plant firmly to the soil surface.***

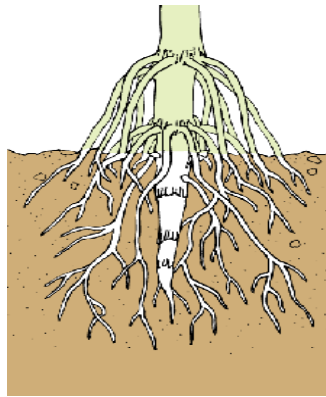

### 5. Buttress roots

These are large thick roots growing from the base of certain stems e.g. *Mvule trees, silk cotton*, etc. ***They provide extra support to the plant by anchoring it firmly in the soil.***

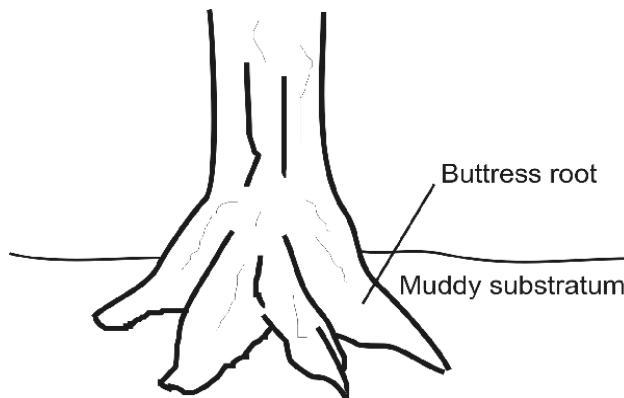

### 6. Clasping roots

These are roots growing from the nodes of climbing stems such as *figs (mituba trees), vanilla and orchids*. They secrete a sticky substance which dries up in air. ***This helps such plants to cling on to other plants for support.***

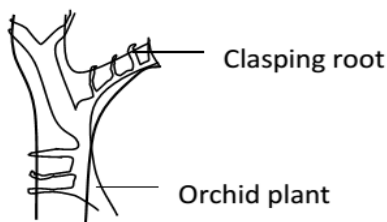

## 7. Epiphytic roots

These grow on certain plants called epiphytes. Epiphytes are plants which grow and get support from other plants. These roots hang freely in the atmosphere.

*They absorb moisture from the atmosphere.*



## 8. Sucking roots

These are roots found growing on certain parasitic plants e.g. *figs (mituba)*. They grow from the stem and penetrate the host plant. *These roots absorb water, mineral salts and organic food compounds from the host plant.*

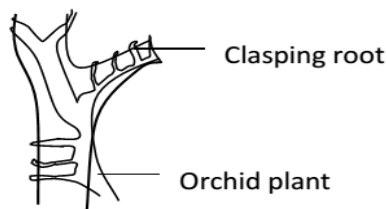

## INTERNAL STRUCTURE OF A ROOT (LONGITUDINAL SECTION)

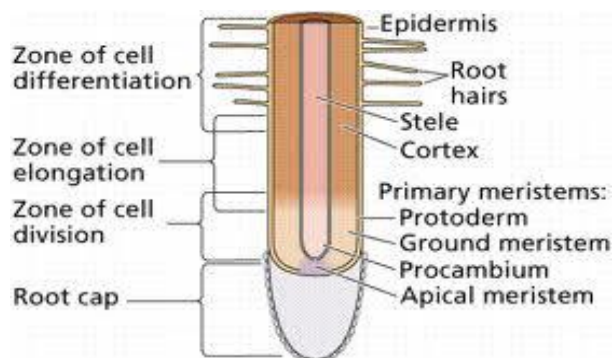

In a longitudinal section through the growing end of a root, its parts are divided into 4 main zone or regions:

- 1) Root cap
- 2) Region of cell division (meristematic region)

- 3) Region of cell elongation
- 4) Region of cell differentiation (maturation)

**1) Root cap**

*This is found at the tip of the root* and is made up of loosely arranged cells. It protects the tender apex of a root from mechanical damage as it makes its way through the soil. It's absent in aquatic plants.

**2) Region of cell division**

This is the growing apex of the root lying just behind the root cap. The *cells in this region undergo repeated divisions* to form new root cap and new cells that increase the length of the root.

**3) Region of cell elongation**

This is the region lying just above the region of cell division. The cells in this region absorb water and develop vacuoles, the cells being elastic, elongated and enlarged. This causes an overall growth in the length of the root.

**4) Region of cell differentiation**

This is also called the region of absorption. The characteristic feature of this region is the development of root hairs; these are fine, delicate, unicellular hair like extensions of epidermal cells (periferous layer). They absorb soil water and dissolved mineral salts from the soil. The cells in this region acquire specific shapes and functions thus they are said to be differentiated or specialized.

**NB:** the region behind the zone of differentiation is the oldest part of the root. It has permanent tissues and is covered by a layer of cork which prevents the evaporation of water from the roots.

**Transverse section of a root**

**1. Monocot root**

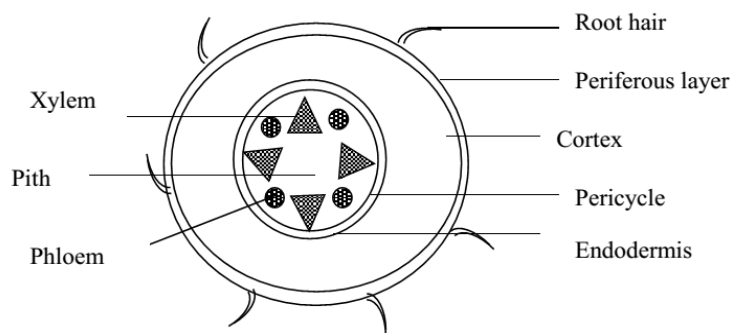

**2. Dicot root**

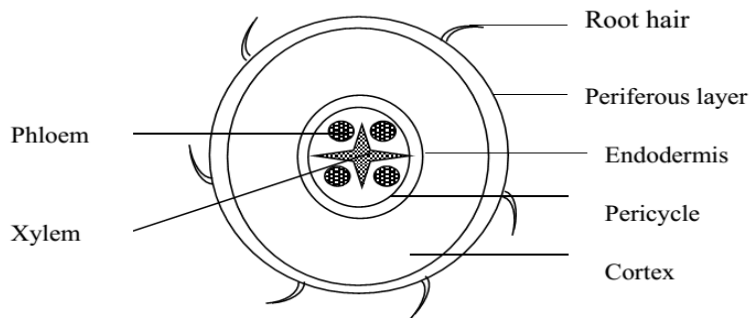

## The transverse or cross section of most young roots has two regions

- The outer cylinder (cortex)
- The central cylinder (stele)

### 1) Cortex

*This is the outer most layer of a root which is wide, composed of many smaller layers of thin walled cells called parenchyma (for strengthening the root).*

It is surrounded by the outer layer within thin walled cells called periferous layer through which root hairs rise.

The periferous layer has no cuticle but the cells forming it have cellulose cell wall.

This allows water and mineral salts to be absorbed from the soil by root hairs.

As the root grows older, the cells die and periferous layer is replaced by cork cells which prevent water loss from the roots.

The inner most layer of the cortex is called endodermis. The endodermis is made of a layer of barrel shaped cells which are thickened so as to allow free movement of water. The endodermis is a ring around the central cylinder (stele).

### 2) Stele

*This is made of a pericycle, vascular tissue and pith (in case of monocots).*

The pericycle is the outermost layer of the stele. It's made up of thin walled cells. It surrounds the vascular tissues of the root and it produces lateral roots.

The vascular tissues are composed of xylem and phloem and may contain cambium and pith tissues.

*Xylem is the water conducting tissue through which water and mineral salts pass from the soil upwards to the stem and leaves.*

***Phloem** is the food conducting tissue that carries manufactured food from the upper parts of the plant mainly leaves and distributes it to various parts of the root.*

**Cambium:** *causes secondary thickening of the root.* It adds all secondary xylem cells on its inner side and secondary phloem cells on its outer side by continuous cell division during growing season.

**Pith:** *is a small area in the centre of the monocot root. It is composed of parenchyma cells for strengthening the root.* It's normally absent in most roots because the centre is normally occupied by the xylem. It also stores food and water for the plant.

### Differences between transverse section of monocot and dicot roots

Dicot root	Monocot
1. Has no pith.	Has pith.
2. Can form a ring of cambium.	Cannot form a ring of cambium.
3. The xylem is star-shaped occupying the central part.	The xylem and phloem alternates forming a ring.

### STEMS

This is the ascending portion of the plant axis that develops from the plumule of the embryo. It has the following characteristic features;

- i) It bears leaves at the nodes.
- ii) It has nodes and internodes.
- iii) It has buds in the axills called axillary buds.
- iv) It has flowers or fruits.
- v) Its terminal bud is located at the tip of the stem.

**NB:** the axill is the angle between the leaf and the stem.

### Functions of stems

#### a) **Primary functions**

- i) They hold leaves in the best position for receiving enough sun light needed in the process of photosynthesis.
- ii) They conduct water and mineral salts from roots to leaves and manufactured food from leaves to other parts.

- iii) They hold flowers and fruits in good position so that they can be easily pollinated or dispersed.
- iv) When stems are young, they carry out photosynthesis thus making food for the plant.
- v) Stems have lenticels (pores) that facilitate gaseous exchange.

### **b) Secondary functions**

- i) Some stems may specialize in storing food and water e.g. stem tubers like corms, Irish potatoes, rhizomes and sugar cane.
- ii) Protect a plant against browsers by forming thorns, spines or prickles.
- iii) Vegetative reproduction or propagation through the stem cuttings e.g. cassava and sweet potatoes.
- iv) They support the plant by climbing stem tendrils e.g. *pasum* pea (wild pea).

## **TYPES OF STEMS**

### **1) Erect stems**

These can support themselves in an upright position. They may be woody or herbaceous.

**Woody stems:** These have a high content of lignin and are hard. They are found in shrubs and trees.

**Herbaceous stems:** These contain no or less woody materials e.g. tomatoes, rice. The herbs are shorter than grass.

### **2) Weak stems**

These can't support themselves upright but either creep or climb for support.

### **3) Underground stems**

These are modified stems which remain permanently underground. They are often swollen and serve as food storage organs.

**NB:**

- Annual herbs only live for one year
- Bi – annual herbs live for two years
- Perennial herbs live for many years

## **MODIFICATION OF STEMS**

## Weak stems

### 1. Twinning stems (twinners)

These are stems that grow ascending spirally around a support. They are usually long and slender e.g. Dutch man's pipe and lianas.



### 2. Climbing stems

These are stems that grow clinging to the support of other plants by means of tendrils. Tendrils are thin wire-like spirally coiled branches of certain stems. They may be modified at axillary buds e.g. in passion fruit plants or terminal buds.

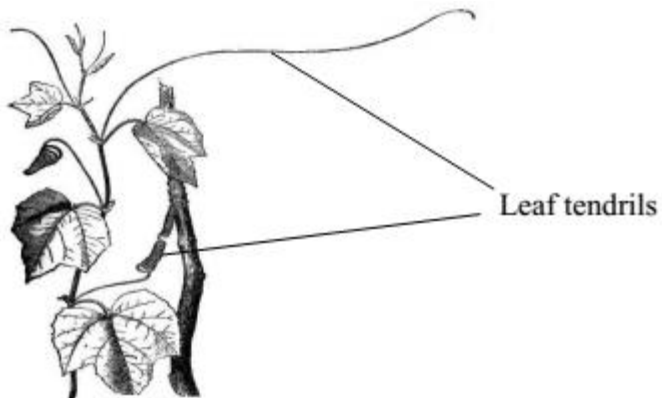

### 3. Creeping stems (creepers)

These are long thin stems which grow along the surface of the ground, giving off roots at certain intervals of the nodes. Four types of creeping stems are;

#### a) Runners

This is a slender trailing stem lying flat on the ground possessing long internodes. A runner arises as an axillary bud and creeps some distance away from the mother plant and grow into another plant e.g. oxalis.

## **b) Offset stems**

This is a horizontal thickened short stem. It originates from the axil of the leaf and grows flat on the ground. It produces many leaves above and a cluster of roots below e.g. water hyacinth and water lettuce.

## **4. Sucker**

A sucker is a creeping stem that grows obliquely upwards, directly giving rise to a leafy shoot. E.g. banana, pineapple, sisal plant, etc.

## **Underground stems**

There are four types of underground stems namely:

- 1) Rhizome
- 2) Corm
- 3) Stem tuber
- 4) Bulb

### **1. Rhizomes**

This is a horizontal thick underground stem having adventitious roots growing from the lower side of the nodes. It has terminal buds which develop into aerial shoots. It bears buds in axils of the reduced brown leaves called scale leaves.

Rhizomes store a lot of food for the plant. Some also act as organs for vegetative propagation e.g. ginger, canary, couch grass and Solomon's seal.

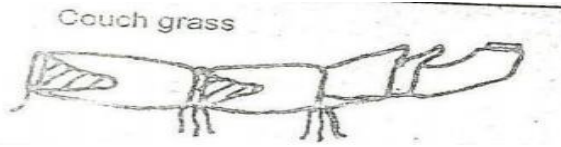

## 2. Stem tuber

This is a short, fleshy underground stem swollen with large amounts of stored food. It has scale leaves and axillary buds which form the “eyes” e.g Irish potato, yams.

## 3. Stolon

A stolon is a horizontally growing stem that roots at the nodes and develops buds that grow into new plants. E.g. straw berry.

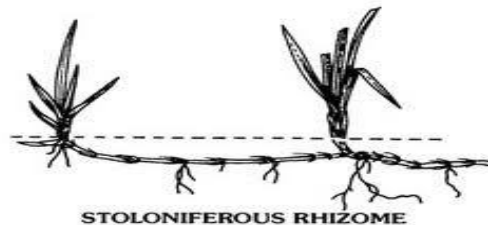

## 4. Bulb

A bulb is short conical-shaped underground stem comprising of thick fleshy leaves arranged in concentric circles. The thick fleshy leaves store food for the plant and are protected by outer dry brown leaves called scale leaves.

A terminal bud lies at the top of the stem and give rise to the aerial shoot. Axillary buds are situated between the leaf bases. Onions, garlic, tuberose, etc. are bulbs.

### Structure of a bulb (onion)

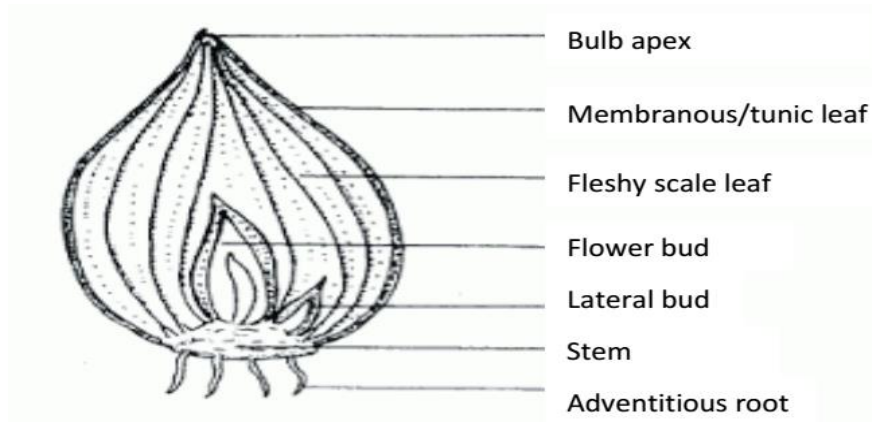

## 5. Corm

A corm is a swollen fleshy underground stem that grows in a vertical direction. It is round-shaped and somehow flattened from the top to bottom. It has a terminal bud lying at the top of the stem and has scale leaves arising from the nodes. Its roots grow randomly from the stem. Examples of corms are cocoyams, crocus, and yams.

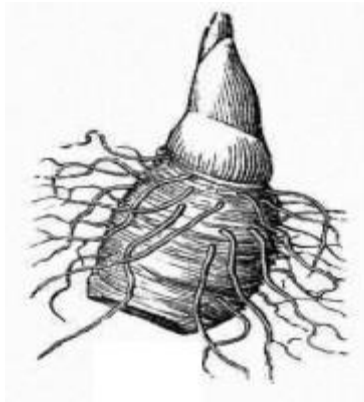

## INTERNAL STRUCTURE OF STEMS

### Transverse section of a dicot stem

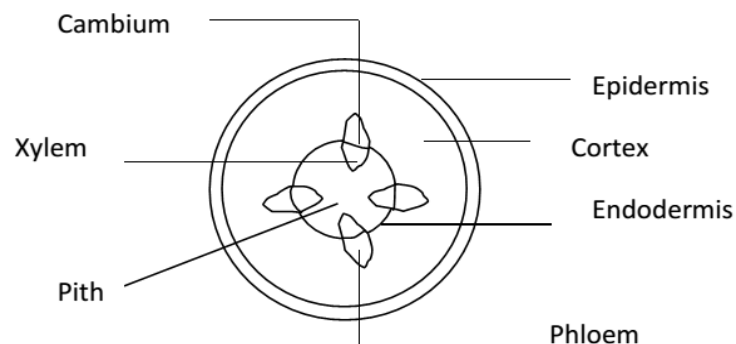

## Transverse section of a monocot stem

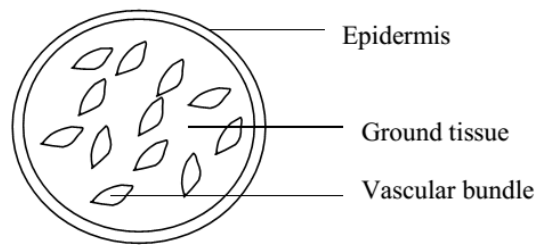

**Internally stems have 3 main tissues;**

### 1. Epidermis

It comprises of a single layer of cells which are brick-shaped. The outer wall of these cells is thickened by cutin, a waxy material which forms the outside skin of a stem called cuticle.

- ❖ It protects the stem against water loss.
- ❖ It also protects the inner tissues of the stem from mechanical injury.
- ❖ It prevents entry of bacteria and germs into stem.

### 2. Cortex

This is the part of the stem between the epidermis and the vascular bundles. It's made up of collenchyma, parenchyma and endodermis.

#### i) Collenchyma

This is the outer tissue of the cortex. It's 3 or more cells thick. The cells are small, tightly packed and thickened at their corners. They offer mechanical support, hence strengthening and giving rigidity to the stem.

#### ii) Parenchyma

This is made up of large thin walled cells. These cells have air spaces between them called intercellular spaces. The spaces provide passage for water vapour and gases in the stem. Parenchyma cells offer support to the stem when filled with water and store some food.

#### iii) Endodermis

This is a single layer of rectangular shaped cells. It contains starch usually, and its main function is storage of food.

### 3. Vascular bundles

These are conducting or transporting tissues of a plant. They consist of xylem and phloem. The phloem lies externally and the xylem lies internally in each bundle.

## **Phloem:**

The phloem conducts and transports manufactured food. It is made up of three main cells:

### **i) Sieve tubes**

These are cylindrical tubes arranged end to end in long rows. Their cross-walls have many fine pores forming a sieve plate. They conduct manufactured food in the stem.

### **ii) Companion cells**

These are smaller than the sieve tubes. They are filled with a dense cytoplasm and have nucleus. They control the activities of the sieve tubes.

### **iii) Phloem parenchyma**

It stores some food in the stem. They are the first to be formed in the vascular bundle.

## **Xylem:**

Xylem is water and mineral salts conducting tissue. It comprises of 2 types of cells i.e. vessels and tracheids. These cells have their walls thickened with a substance called lignin.

The xylem also provides mechanical strength to the stem due to the presence of lignified dead cells.

The lignified dead cells formed between the endodermis and phloem is termed as sclerenchyma.

### **Differences between dicot and monocot stems**

<b>Monocot stem</b>	<b>Dicot stem</b>
Lack cambium	Has cambium. The cambium is responsible for secondary growth or thickening of the stem.
The vascular bundles are scattered within the stem.	The vascular bundles are arranged in form of a ring.
Lack a distinct cortex and pith.	Has a distinct cortex and pith. The pith is wide.
Its cortex has several layers of parenchyma cells.	Its cortex has a few layers of parenchyma cells.

## LEAVES

A leaf is a thin flattened structure which grows from the nodes of a stem or its branches and has a bud in its axil. Leaves are generally green although some are red or brown. The leaf is made up of 3 main parts;

### External structure of a leaf

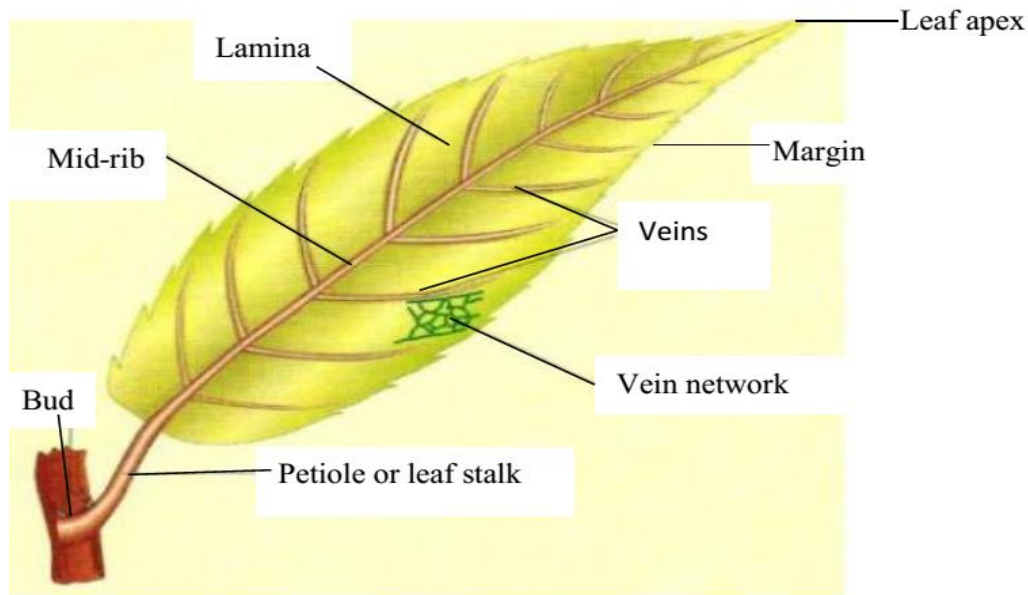

### The monocot leaf

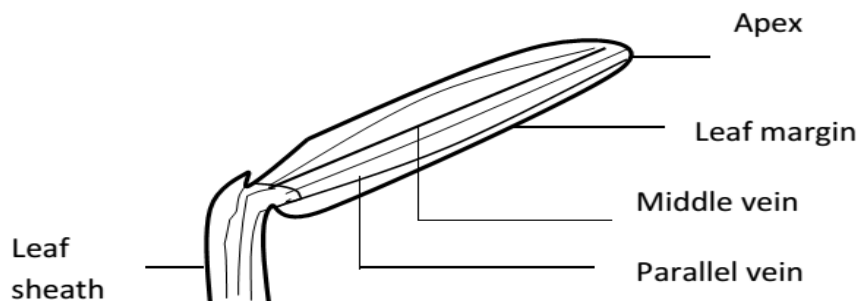

**Leaf base;** this is the part which attaches the leaf to the stem.

**Petiole;** this is the part which connects the leaf base to the leaf blade. Leaves with a petiole are called *petiolate* and those without are called *sessile*.

The *leaf stalk* is a characteristic of dicots while a *leaf sheath* is found in monocots. The leaf stalk/sheath can be hairy or smooth.

**Lamina;** this is the expanded and flattened portion of the leaf consisting of veins and midrib.

**Texture of lamina;** the lamina may be hairy or smooth. It may be hard or soft.

## VENATION

The arrangement of veins in the lamina of a leaf is called venation. Two broad types of venation are;

### 1. Network venation

In network venation, the veins in the lamina branch while intersecting to form a network. It's a characteristic of dicots.

### 2. Parallel venation

In this venation, the veins run side by side without branching. This is a characteristic of monocotyledonous plants.

## LEAF COMPLEXITY

Leaves can be classified according to whether the leaf lamina is completely divided or not divided. Two broad types are:

- ✚ Simple leaves
- ✚ Compound leaves

### 1. Simple leaves

A simple leaf has a single lamina which isn't divided up into leaflets e.g. Avocado, mango, orange, hibiscus, pawpaw, cassava, etc.

Cassava and pawpaw leaves are partly divided. The lobes are not considered to be leaflets because the divisions do not reach down the midrib. They are simple digitate i.e.

#### Simple leaf of a mango



#### Simple leaf of cassava

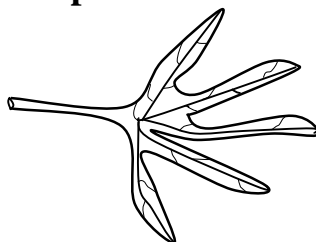

A swelling at the base of the leaf stalk is called *pulvinus* e.g. beans and cassava. Some leaves have it while others do not have it.

## 2. Compound leaves

A compound leaf has a lamina which is completely divided into leaflets. They resemble leaves but are not leaves because the axillary buds are absent in the axis of leaflets e.g. beans, oxalis, cassia, etc.

### Types of compound leaves

#### i) Compound pinnate leaves

These are compound leaves with leaflets arranged either in pairs opposite one another or alternately along the midrib called rachis of the leaf. If the terminal leaflet is present, the leaf is said to be *imparipinnate* and if the terminal leaflet is absent, the leaf is said to be *paripinnate*.

#### Imparipinnate

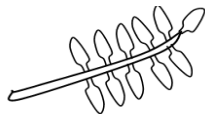

#### Paripinnate

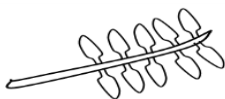

#### ii) Compound bipinnate leaves

These are compound leaves with 2 orders of leaflets. Leaflets are further divided up to form leaf-like structures called pinnules e.g. jacaranda.

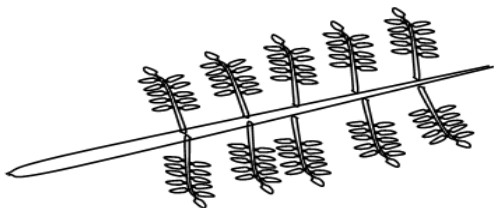

#### iii) Compound digitate leaves

These are compound leaves with leaflets radiating out from the end of the petiole-like fingers of the hand.

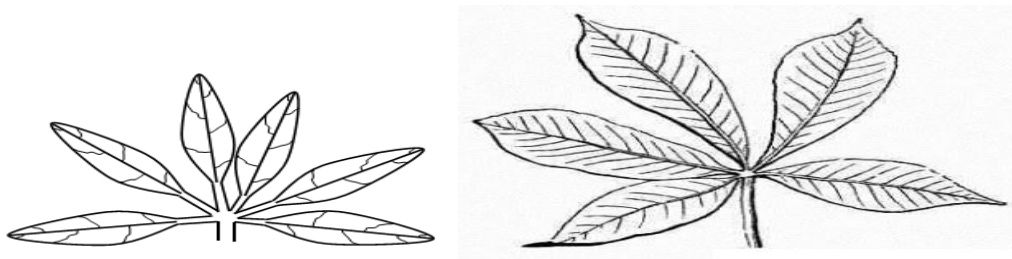

#### iv) Compound trifoliate leaves

These are compound leaves with only 3 leaflets. They include soya beans, oxalis and straw berry.

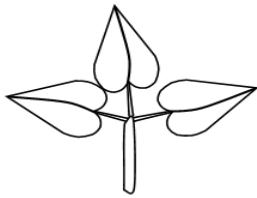

**NB:** stipules (foliar appendages) are attached to the leaf base or petiole e.g. in beans, hibiscus and cassia.

### INTERNAL STRUCTURE OF A LEAF

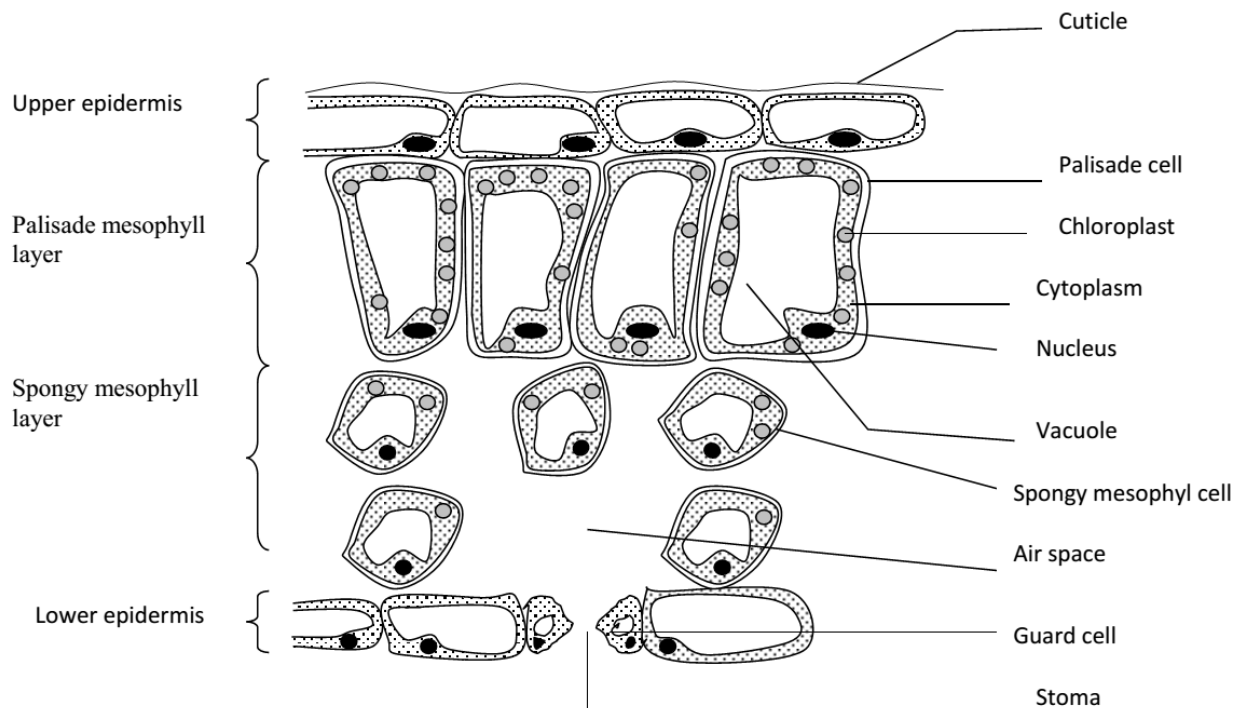

#### 1. Epidermis:

This is the outer most layer of a leaf. It acts as a skin covering the whole leaf surface. It's covered by a transparent water porous layer of cutin called cuticle.

This cuticle allows light penetration into the leaf and prevents excess water loss from the leaf surface.

The epidermal tissue is divided into 2 according to the location on a leaf i.e. upper and lower epidermis. The upper epidermis is a single layer of brick-shaped cells covered by a thick cutin in case of terrestrial plants or land plants.

In most plants, it does not possess stomata and if present are few. This is so as to control the amount of water loss during transpiration process.

The major function of this epidermis is to prevent evaporation of water from the leaf cells and protection of the inner cells.

The lower epidermis is usually made up of one layer of cells and contains numerous openings called stomata. These stomata are protected by 2 guard cells. In water plant e.g. water lily or hyacinths, stomata are few on this side of the leaf. Some chloroplasts are present in this layer of cells.

### **Stomata**

These are small openings found in the epidermis of a leaf. They are surrounded by 2 guard cells. Plants growing on land have more stomata located in the lower epidermis than in the upper epidermis. ( the reverse is true for aquatic plants)

The function of the stomata is to allow entry and exit of important gases like O<sub>2</sub> and CO<sub>2</sub> into the leaf.

The stomata also regulate the loss of water vapour from the plant i.e. they control transpiration.

### **Structure of the stomata**

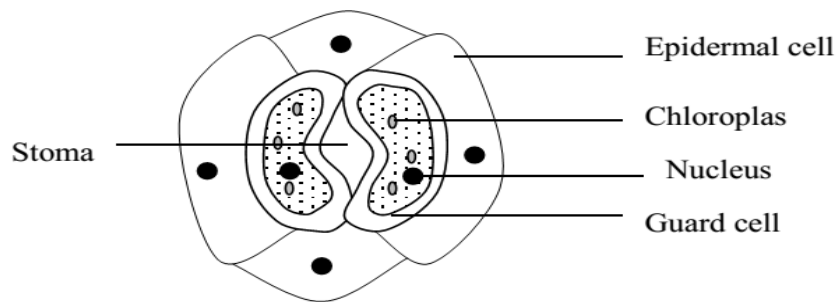

### **2. Mesophyll:**

This is located between the upper and the lower epidermis. It's differentiated into two layers. i.e.

### **i) Palisade layer**

It's found just below the upper epidermis. It's made up of cylindrical shaped cells. The cells are closely packed together without air spaces. The palisade cells contain many chloroplasts which are the major sites for photosynthesis.

Chloroplasts are small and made up of proteins. They contain chlorophyll which gives green plants their colour. The chlorophyll absorbs sun light energy that is used in the process of food manufacture (photosynthesis).

### **ii) Spongy mesophyll layer**

It's found under the palisade layer. It consists of cell called spongy cells which are irregularly arranged. These cells are not closely arranged, and therefore have large intercellular air spaces between them. The air spaces are connected with each. There is also the sub-stomatal air chamber where the gases collect before moving out of a leaf. Spongy cells contain fewer chloroplasts than the palisade cells hence they manufacture food.

### **3. Vascular tissue**

These are vascular bundles consisting of veins. Each vein has a phloem for transporting manufactured food and the xylem for conducting and distributing water and mineral salts. The veins also provide mechanical support to the leaf lamina.

## **ARRANGEMENT OF LEAVES ON A STEM**

Arrangement is the insertion of leaves on the stem. Leaves develop at the nodes in the stem and are arranged in different ways.

### **1. Alternate**

This is when one leaf only arises from each node and the nodes are at different levels and the successive nodes are at different nodes.



### **2. Opposite**

This is when two leaves arise from nodes that are opposite each other and are at the same level.



### **3. Whorls**

This is where more than 2 leaves arise from each node.



## **TYPES OF LEAF MARGINS**

Leaves can be classified according to the leaf margins.

### **1. Entire margin**

The margin is smooth and without indentation of any kind. E.g. mango leaves.

### **2. Serrate margin**

The margin is with indentations pointing towards the apex.

### **3. Dentate margin**

The margin has indentations pointing towards the petiole.

### **4. Crenate margin**

The margin has round indentations.

### **5. Lobed margin**

The margin has relatively few and shallow indentations.

## **Types of leaf shapes**

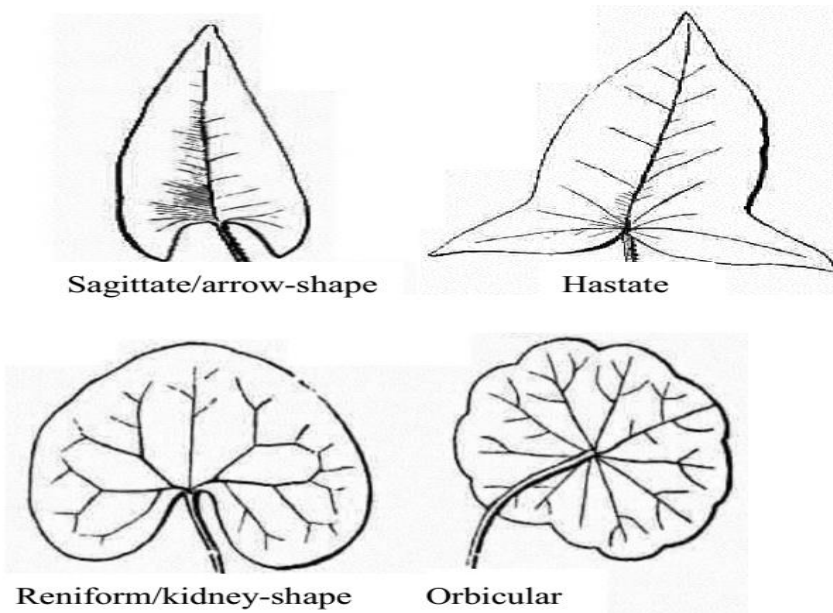
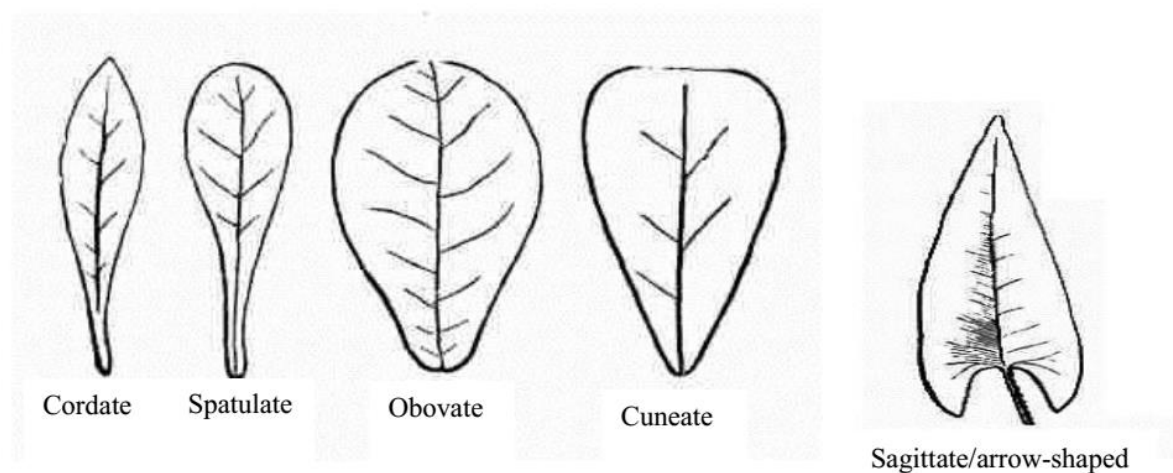
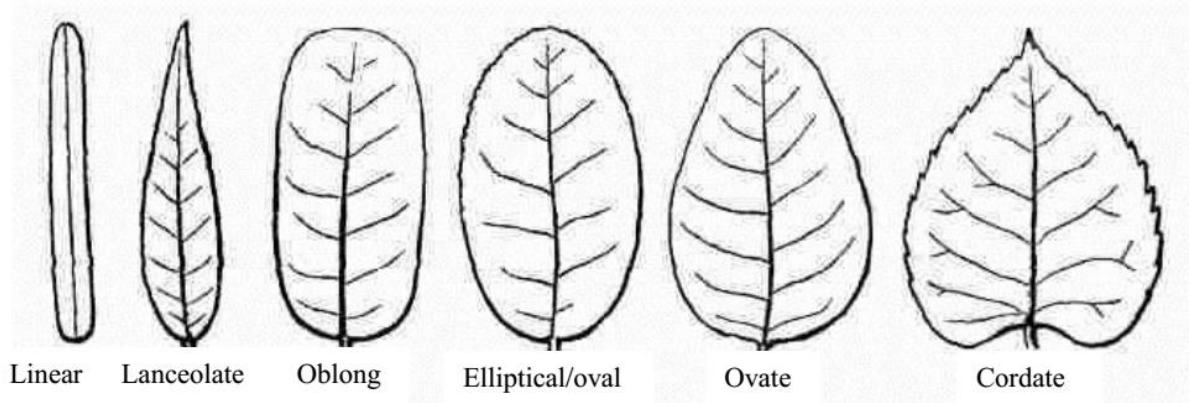

### Functions of leaves to plants

#### a) Primary functions

- The major function is to manufacture food for the plant during photosynthesis.
- Leaves have stomata which allow exchange of gases i.e.  $O_2$  and  $CO_2$ .

- Leaves facilitate transpiration which sometimes helps the removal of excess water within the plant.

#### **b) Modified or secondary functions**

- They store food and water for the plant e.g. the thick fleshy leaves of onions.
- Some plant leaves are useful in vegetative reproduction e.g. bryophytes.

### **Modification of leaves**

Leaves of some plants have become modified to perform other functions other than photosynthesis.

#### **1. Leaf tendrils**

These are slender wire like coil structures used as climbing organs in climbers for support. The leaf may be partly modified into a tendril.

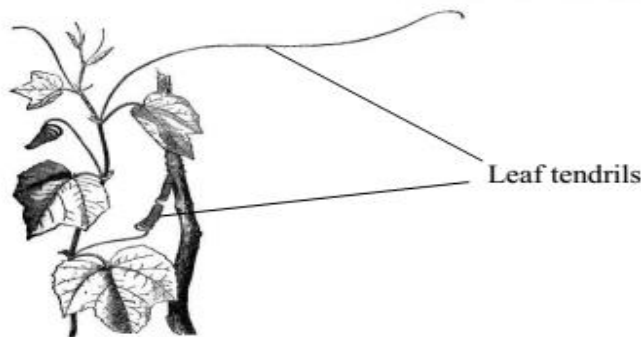

#### **2. Leaf spines**

These are sharp pointed structures of certain plants modified for defense.

#### **3. Scale leaves**

These are thin, dry membranous structures usually brown in colour and sometimes colourless. Their main function is to protect the axillary bud from mechanical injury and drying out. They are commonly found on underground stems. E.g. scale leaves of onions, rhizome and garlic.

#### **4. Insectivorous leaves**

These are modified leaves whose function is to capture and digest insects. Such plants are called insectivorous plants. Pitcher plants grow in soil with a deficiency of nitrogen/nitrates. They obtain nitrogen from insects. E.g. Venus fly trap, butter wort, sundew, bladder wort, nepenthes, and the pitcher.

#### **5. Bryophyllum leaves**

Leaves have series of buds at the end of vein. These buds grow into new plants (plantlet) when the leaf is mature.

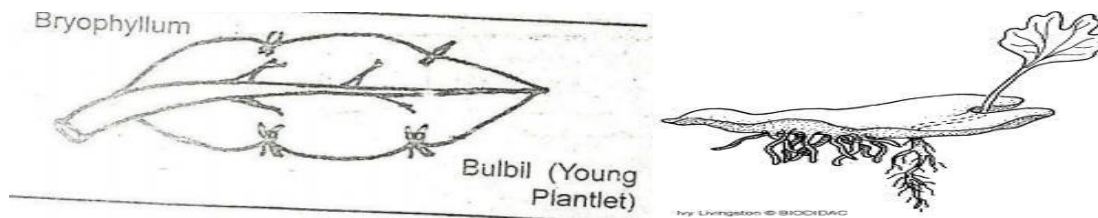

## THE FLOWER

The flower is part of the shoot specialized for reproduction. Most flowers have male and female reproductive organs though some are of a single sex. A group of flowers is called an *inflorescence* e.g. maize flower.

### General structure of a flower

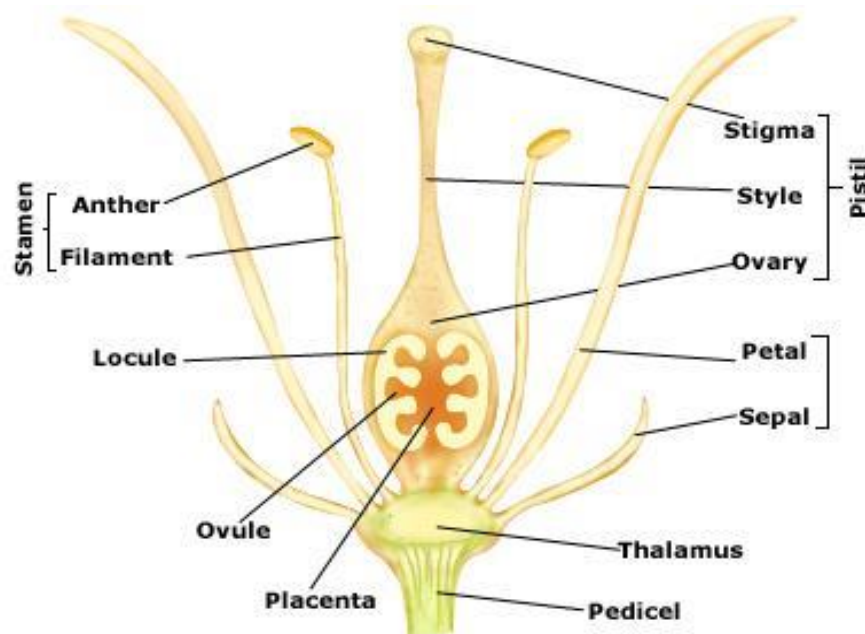

### Structure of a hibiscus flower (external structure)

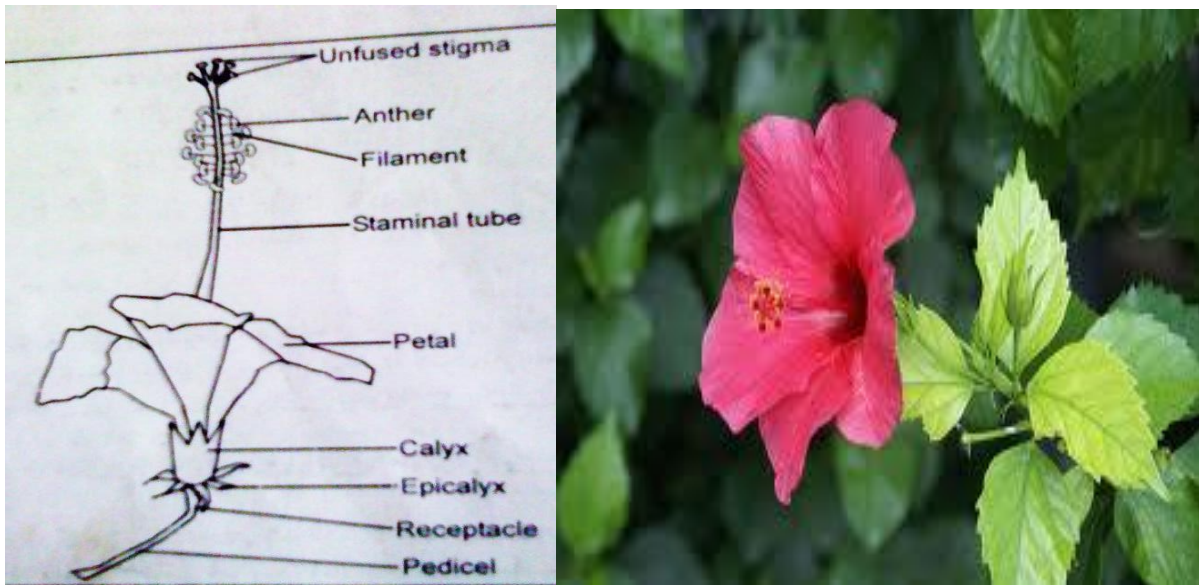

**Internal structure of a hibiscus flower**

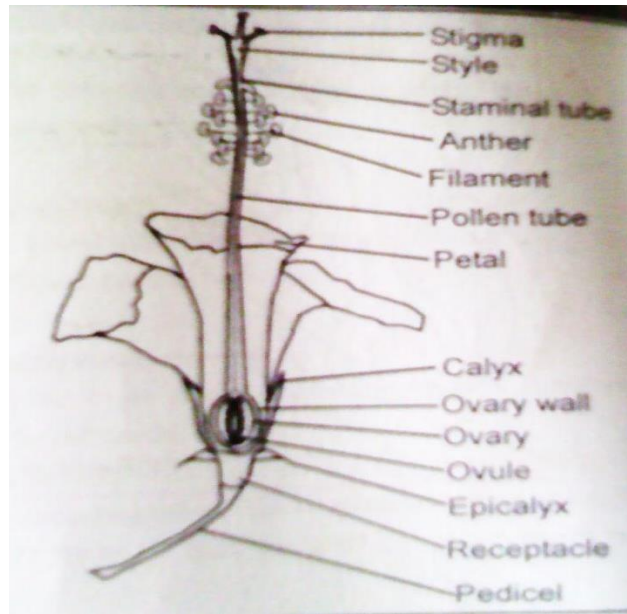

*When petals, calyx, epicalyx and the sheath of the staminal tube have been removed, this is shown in the diagram*

***Spikelet of the male maize flower***

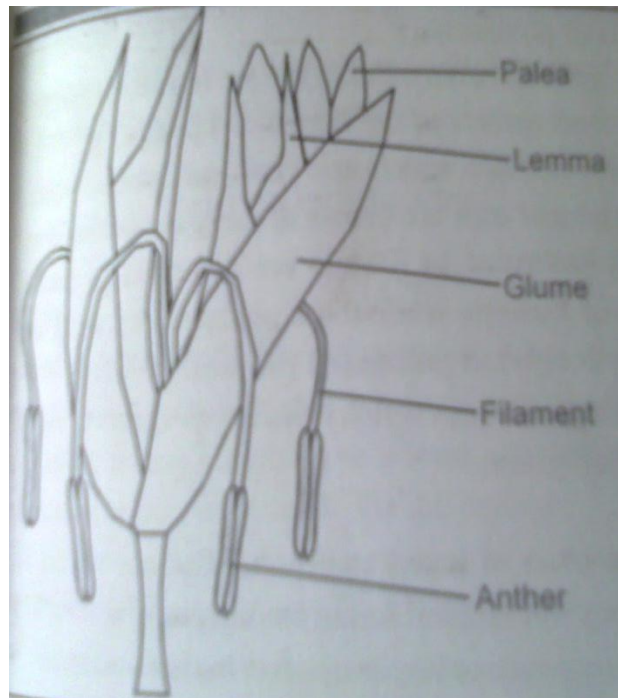

### *Single grass flower*

Grass and male maize flowers grow in groups along the same axis. The flowers are in pairs and each pair is called a *spikelet*. The whole individual flower is called a *floret*. These flowers have no petals or sepals instead they have green leaf-like structures called *bracts*. The outer and larger bract is called *lemma* and the inner smaller one is called *palea*. At the base of each spikelet is a pair of modified leaves called *glumes*.

## Parts of a flower

The floral parts are arranged in rings, spirals or whorls with short internodes. The end of a flower stalk may be expanded to form a receptacle. The stalk of the flower where floral parts grow is called pedicel.

The four floral whorls are

- Calyx
- Corolla
- Gynoecium
- Androecium

The calyx is the outer most floral whorls of the flower made up of sepals. The calyx protects the inner whorls of a flower during the bud stage.

The corolla is the second floral whorl of a flower made up of petals. Most flowers have scented petals to attract insects for pollination e.g. hibiscus, crotalaria, coffee, morning glory, etc. the calyx and corolla are collectively known as Perianth.

Androecium is the male part of the flower consisting of stamen. Each stamen is made up of filament and head called anther. Anthers contain pollen grains which develop to form male reproductive cells called gametes.

N.B: an infertile or sterile stamen is called staminode.

Gynoecium (pistil) is made up of female reproductive parts called carpels. The pistil occupies a central position in the flower. Each carpel is made up of;

- ✓ Ovary which contains ovules or female gametes.
- ✓ Style which connects the ovary to the stigma
- ✓ Stigma which receives the pollen grains

The wall of the ovary develops into the pericarp of the fruit. Nectaries are swellings often at the base of the ovary or on the receptacle which produce a sugary solution called nectar.

## Types of pistils

Three main types of pistils are:

### 1. Monocarpous

This is a pistil with only one carpel e.g. morning glory and cow pea.

## **2. Syncarpous pistil**

This is a pistil with carpels fused together e.g. hibiscus and isolanum.

## **3. Apocarpous pistil**

This is a pistil with several carpels which are not fused i.e. as distinct carpels e.g butter cap and Bryophyllum.

### **Types of ovaries**

The two types of ovaries include the following

#### **1. Superior ovary**

Is the one that arises above the other floral parts e.g. hibiscus, cassia, commelina, mimosa pudica, etc.

#### **2. Inferior ovary**

Is the one which arises below the rest of the floral parts e.g. morning glory.

### **Hypogenous**

The gynoecium is situated at the apex of the receptacle and other whorls arise below it. The sepals and petals are inserted independently below gynoecium. Hypogenous flower has superior ovary.

### **Terms used**

**Complete flower:** A flower having all the four whorls or floral parts i.e. calyx, corolla, stamen and pistil.

**Incomplete flower:** A flower lacking one or more of the four floral parts.

**Perfect flower:** Is a flower with both male (stamen) and female (pistil) parts.

**Imperfect flower:** A flower lacking either stamen or pistil.

**Unisexual flower:** Has only one of the sexual parts i.e. staminate; when the flower has stamens only. Pistillate (carpellary) when it has carpels only.

**Staminode:** sterile stamen.

**Bisexual (hermaphrodite) flower:** is one that contains both male and female organs or parts.

**Monoecious plant:** Is one that has the pistillate and staminate that are born on the same plant but at different points on the plant e.g. maize and castor oil plants.

**Dioecious plant:** is one that bears either pistillate or staminate flower only e.g. pawpaw.

**Dichogamy:** Is a condition in which the male and female parts of a flower mature at different times. There are 2 types;

- **Protandry:** when the anthers mature before the stigma.
- **Protogyny:** where by the stigma matures before the anthers.

**Regular (actinomorphic) flower:** a flower which can be divided symmetrically (equally) in different planes.

**Irregular (zygomorphic) flower:** is one which can be divided into 2 similar halves in only one plane.

**Polysepalous:** is when the sepals are borne free or are separate and are distinct from each other.

**Gamosepalous:** is when the sepals are fused or joined together.

**Petaloid:** Sepals resembling petals and have the same colour.

**Gamopetalous:** Are petals which are wholly joined or fused together e.g. morning glory, sweet potatoes.

**Sepaloid:** They are petals which resemble sepals and are green in colour.

**Septum:** Is an internal dividing wall or partition within a syncarpous ovary.

**Locules:** Is an internal compartment of an ovary of fruits.

*Simple flowers may be borne on a common flower stalk called peduncle while individual flowers may be borne on a pedicel.*

## POLLINATION

Pollination is the transfer of pollen grains from the anther to the stigma of a flower. There are two types of pollination.

1. **Self-pollination.** This is the transfer of pollen grains from the anther to the stigma of the same flower or between two flowers on the same plant.
2. **Cross-pollination.** This is the transfer of pollen grains from the anthers of one flower to the stigma of another flower on a different plant but of the same species.

### **Agents of pollination**

These are things that aid the process of pollination. The agents of pollination include.

Animals, Water, Wind and Artificial pollination

There are however two major agents that is wind and insects. Pollination can therefore be described as wind pollination and insect pollination.

### **Characteristics of insect pollinated flowers**

- i) They have brightly coloured petals to attract insects.
- ii) They have a scent to attract insects
- iii) They have large conspicuous petals, which act as landing sites for insects.
- iv) They have sticky pollen grains, which stick to the insects body.
- v) They have sticky stigmas, which hold pollen grains.
- vi) They produce few sticky pollen grains.
- vii) They produce heavy pollen grains.
- viii) They produce nectar from nectarines to attract insects.

### **Characteristics of wind pollinated flowers.**

- i) They have dull coloured petals.
- ii) They have small petals.
- iii) They produce light pollen grains, which can easily be carried by wind.
- iv) They do not produce nectar
- v) They have feathery stigmas to trap pollen grains carried by wind.
- vi) They produce a lot of pollen grains.
- vii) They have no scent
- viii) They have long stamens and pistils hanging outside the petals to release and receive respectively pollen grains easily.

### Differences between insect and wind pollinated flowers.

<b>Insect pollinated flower</b>	<b>Wind pollinated flower</b>
Have brightly coloured petals	Have dull coloured petals
Have a scent	Have no scent
Produce nectar from nectarines	Produce no nectar
Have large petals	Have small petals
Produce few pollen grains	Produce a lot of pollen grains
Have sticky stigmas	Have feathery stigmas
Produce heavy pollen grains	Produce light pollen grains
Have short pistils	Have long pistils
Have short stamens	Have long stamens

### Characteristics of flowers pollinated by nocturnal insects

Nocturnal insects are those insects, which are active at night. Flowers pollinated by such insects have the following characteristics.

1. They have light coloured petals mainly white and pink.
2. They produce a strong scent.
3. They open their petals at night and close them during daytime.

### Modifications of flowers to prevent self-pollination

1. **Protandry.** This is a situation where stamens ripen before the stigma such that when pollination occurs, the pollen grains cannot germinate on the immature stigma.
2. **Protogyny.** This is a condition where the stigma ripens before the anthers.
3. **Dioecious condition.** This is a condition where a plant bears either pistillate or staminate flowers but not both.

4. **Self-incompatibility.** This is where pollen grains from the same flower fail to fertilize the stigma of that flower.
5. **Structure of the flower.** Sometimes the carpel is taller than the stamens of the same flower and in some flowers the corolla covers the stamens preventing self-pollination.

## FERTILIZATION IN PLANTS

This is the fusion of male and female gamete to form a zygote. Fertilization in plants is internal taking place inside the ovary in the structure called embryo sac.

### The process of fertilization in plants:

1. Pollen grain lands on the stigma of a flower of the same species.
2. On the stigma, pollen grain absorbs water, nutrients and then germinates to form a pollen tube which grows through the style under the control of the tube nucleus at the tip.
3. Pollen grain has two nuclei i.e. generative nucleus and pollen tube nucleus. The generative nucleus divides mitotically to form two male nuclei which lie behind the pollen tube nucleus.

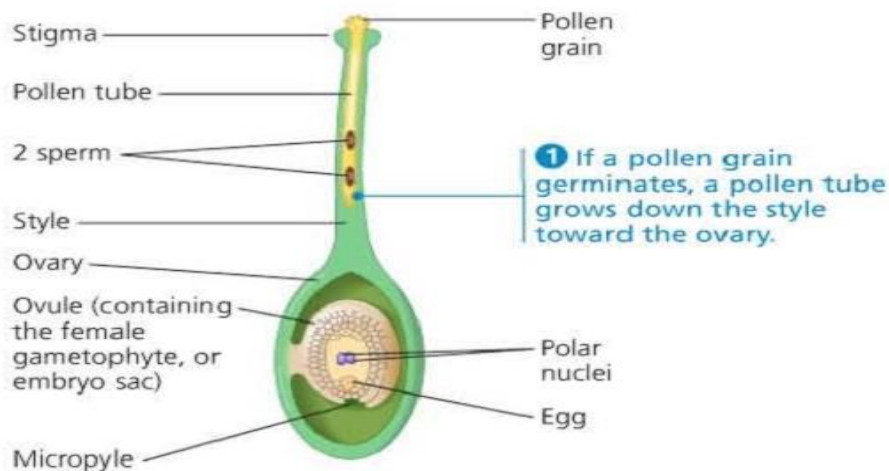

4. The pollen tube enters the ovary and the tip of the pollen tube breaks. The pollen tube nucleus disappears.

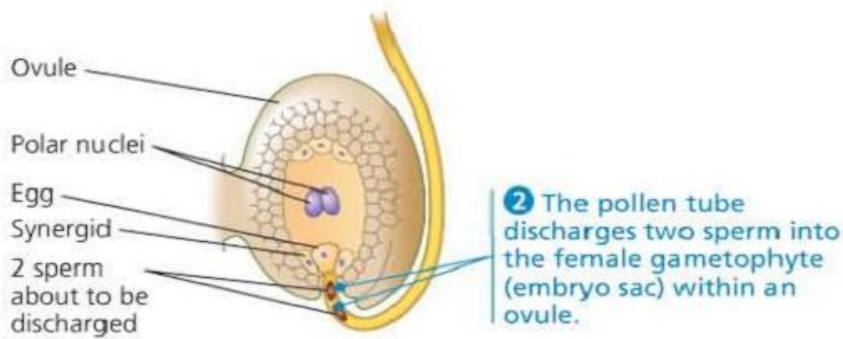

5. One of the male nucleus fuse with the egg nucleus to form a zygote which divides mitotically to form embryo.
6. The other male nucleus fuses with two polar nuclei to form a triploid endosperm which develops into endosperm. This is called double fertilization.

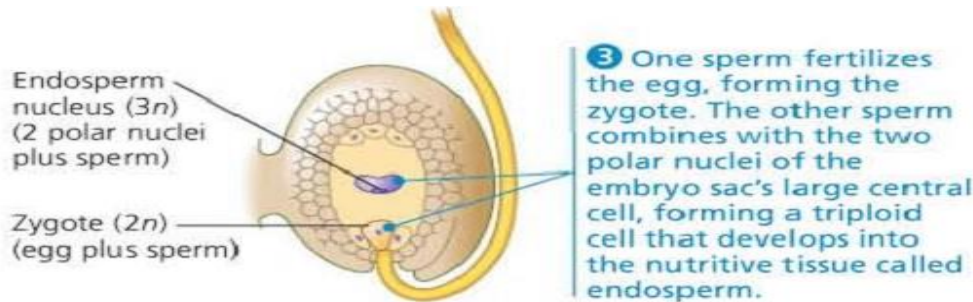

### Events after fertilization

1. The zygote divides mitotically followed by growth and development resulting into an embryo.
2. The triploid endosperm divides mitotically to form good solid organs called endosperm.
3. The ovules develop into seeds.
4. The integuments become the seed coat.
5. The ovary develops into a fruit and ovary wall develops into a fruit wall which protects the seeds.
6. Petals, stigma, style and stamen wither and fall off while the calyx may wither and fall off or may remain in shriveled form.

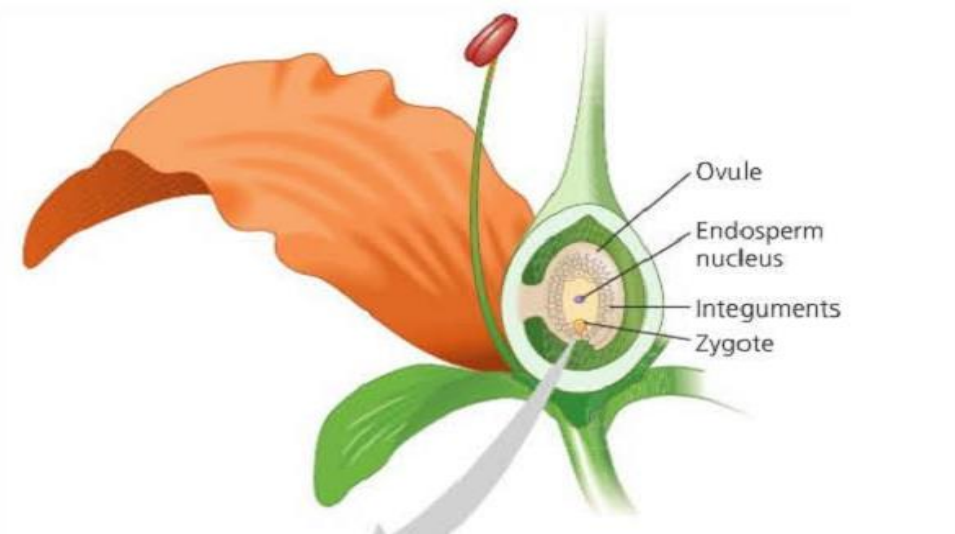

## SEEDS

A seed is a fertilized mature ovule. It has one scar called hilum which is a spot where it was attached to the pod inside a fruit.

### Types of seeds

1. **Monocotyledonous seeds:** These contain only one seed leaf or cotyledon. E.g. cereals like maize.
2. **Dicotyledonous seeds:** These contain 2 cotyledons e.g. legumes like beans, peas and G. nuts.

### External structure of a seed (dicot seed)

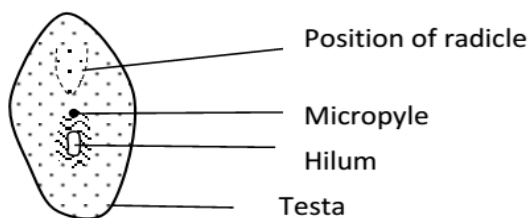

### Internal structure of a dicot seed

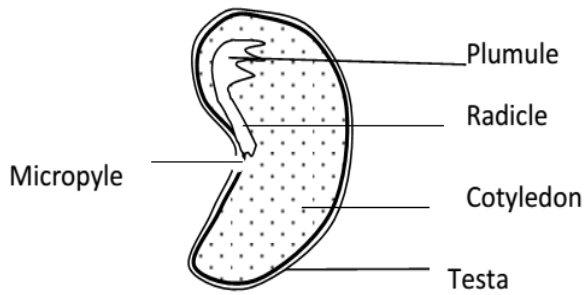

### External structure of a monocot seed

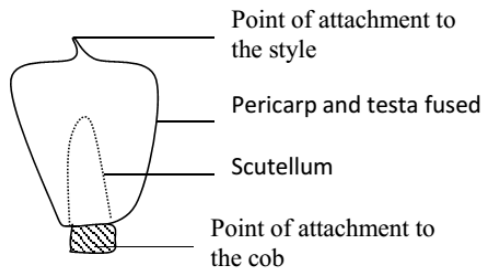

### Internal structure of a maize seed

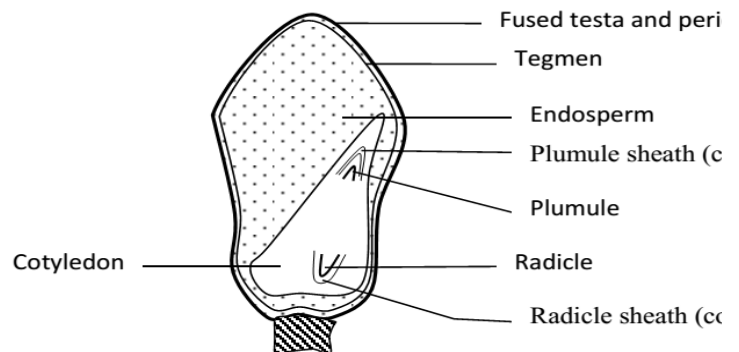

#### i) Testa

It is a protective covering of the embryo of the seed formed from the integuments. It is usually hard and dry. It protects it from fungi, bacteria and insects.

#### ii) Tegmen

It is the inner membrane of the seed coat and its also used for protection.

#### iii) Micropyle

It is a narrow opening into the seed through which water, mineral salts and oxygen enter during germination.

#### iv) Radicle

It is a seed root (embryo root) which develops into primary root of the plant. A developing root has a root cap which bores through the soil particles and protects the newly formed cells at the root tip from mechanical damage.

#### v) Hilum

It's a scar of attachment left by the stalk of the ovule to the ovary wall.

#### vi) Endosperm

Stores food especially starch for the embryo.

#### vii) Scutellum or cotyledon

Digests and absorbs food stored in the endosperm. It provides food to the whole seed.

**viii) Coleorhiza**

It is the radicle sheath that offers protection to the radicle.

**ix) Coleoptile**

It is the plumule sheath that offers protection to the plumule.

**x) Cotyledon**

These contain stored food like starch, proteins and liquids for the initial growth of the embryo during germination.

## **FRUITS**

A fruit is a fully grown fertilized ovary containing one or more seeds. A fruit has 2 scars, one where it was attached to the receptacle and the other, the remains of the style or stigma.

During a fruit formation, the wall of the ovary becomes a fruit wall called pericarp. In some fruits such as banana and pine apple, the fruits develop without fertilization. Such fruit are said to be *parthenocarpic* fruits. Therefore *parthenocarpy is the development of fruits without fertilization.*

### **Classes of fruits**

**True fruits:** develop only from the ovaries of a flower e.g. beans, tomatoes, etc.

**False fruits:** develop from the association of ovaries and other floral parts such as receptacle. Examples include; pineapples and apples.

### **Classification of fruits**

There are 3 groups of fruits namely;

- ❖ Simple fruits
- ❖ Aggregate fruits
- ❖ Multiple fruits

#### **Simple fruits**

These are formed from one flower in which the pistil consists of either one carpel (monocarpic) or of several fused together (syncarpous) e.g. legumes, g, nuts, peas, tomatoes, mango, beans, etc.

## **Aggregate fruits**

These are formed from one flower in which the pistil consists of several free carpels (apocarpous) e.g. apples and rose.

## **Multiple fruits**

These are formed from several flowers and the ovaries become fused after fertilization e.g. jackfruit and pineapple.

## **SIMPLE FRUITS**

There are either dry or succulent according to whether the pericarp becomes dry or juicy as the fruit ripens.

### **Types of simple fruits**

Simple fruits are further divided into three categories.

1. Dry indehiscent fruits
2. Dry dehiscent fruits
3. Succulent fruits.

### **Dry indehiscent fruits**

These are fruits with a dry pericarp that does not split up (dehisce) to release seeds. This category contains five types of fruits. These are Achene, Nut, Caryopsis, Cypsela and Samara.

**The table below shows the different types of dry indehiscent fruits.**

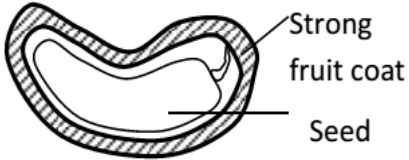
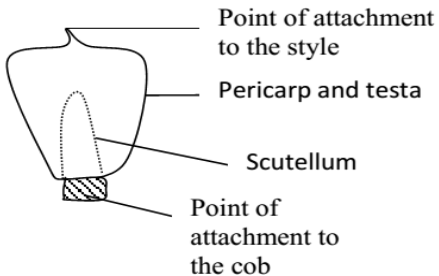
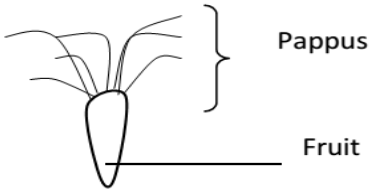
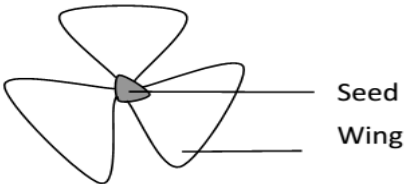

<b>Type of dry indehiscent fruit</b>	<b>Description</b>	<b>Illustrative diagram</b>

<p>Achene</p>	<p>This is a one seeded fruit covered by a dry pericarp, which does not split open, e.g. sunflower. The achene is the simplest fruit.</p>	<p><b>An achene of sunflower.</b></p> 
<p><b>Nut.</b></p>	<p>This is similar to an achene but the pericarp is hard and tough, e.g. cashew nut.</p> <p>Note; coconuts and groundnuts are biologically not nuts.</p>	<p><b>Section through a cashew nut</b></p> 
<p><b>Caryopsis.</b></p>	<p>This is an achene-like fruit in which the testa and pericarp are fused. These are mainly found in grasses and maize.</p>	<p><b>Caryopsis of maize.</b></p> 
<p>Cypsela</p>	<p>This is a fruit similar to an achene in which the inferior ovary has a pappus of persistent calyx. It is common in composite fruits, e.g. tridax and <i>bidens pilosa</i></p>	<p><b>Cypsela of tridax.</b></p> 
<p><b>Samara.</b></p>	<p>This is a fruit similar to an achene in which the pericarp is extended to form one or more wings, e.g. in jacaranda and African rose wood.</p>	<p><b>Samara of jacaranda.</b></p> 

## Dry dehiscent fruits

These are fruits with a dry pericarp that splits (dehisces) to release seeds. The fruits split at particular lines of weakness known as sutures. These fruits are categorized into the following different groups depending on the number of splits that occur on the pericarp. These fruits include, Follicles, Legume, Capsule and Schizocarp.

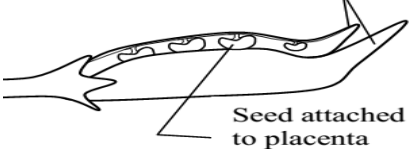
**The table below shows the different types of dry dehiscent fruits**

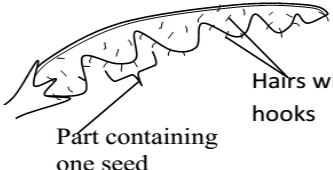
<b>Type of dehiscent fruit</b>	<b>Description</b>	<b>Illustrative diagram</b>
Follicle	This is a dry fruit with many seeds and splits open along one suture, e.g. Sodom apple	<p><b>Sodom apple.</b> Split/suture in fruit wall      Seeds</p> 
<b>Legume.</b>	This is a dry fruit with many seeds and splits open along two sutures, e.g. beans, peas, flamboyant and Barbados pride.	<p><b>Legume of a bean</b> Fruit wall split up and down Seed attached to placenta</p> 
<b>Capsule</b>	This is a dry fruit with many seeds and splits open along many vertical slits. It is formed from an apocarpous flower, e.g. Dutchman's pipe, balsam, cotton, e.t.c.	
<b>Schizocarp.</b>	This is a dry several seeded fruit, which breaks up into separate parts each containing one seed, e.g. desmodium, sweet hearts	<p><b>Schizocarp of desmodium.</b> Hairs with hooks Part containing one seed</p> 

	and some cassia.	
--	------------------	--

### Succulent fruits

These are fleshy fruits. They are either entirely fleshy or have part of it fleshy. They are further divided into 2 types.

#### 1. Drupes.

These are fruits with only one seed and only part of it fleshy (epicarp and mesocarp). The endocarp is fibrous and hard, e.g. mango and avocado.

#### Longitudinal section through a mango

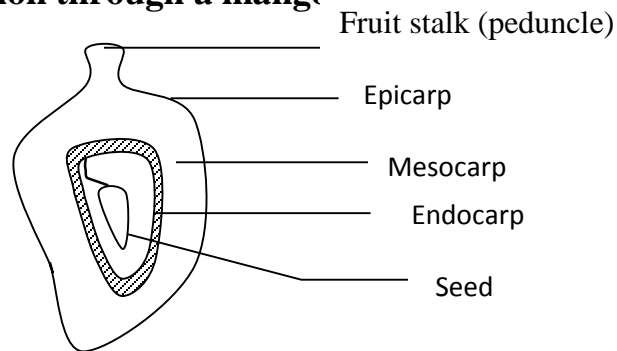

#### 2. Berry.

This is a fruit with many seeds and the whole of it fleshy, e.g. tomatoes, guavas, oranges, bananas etc.

#### A berry of an orange (T.S).

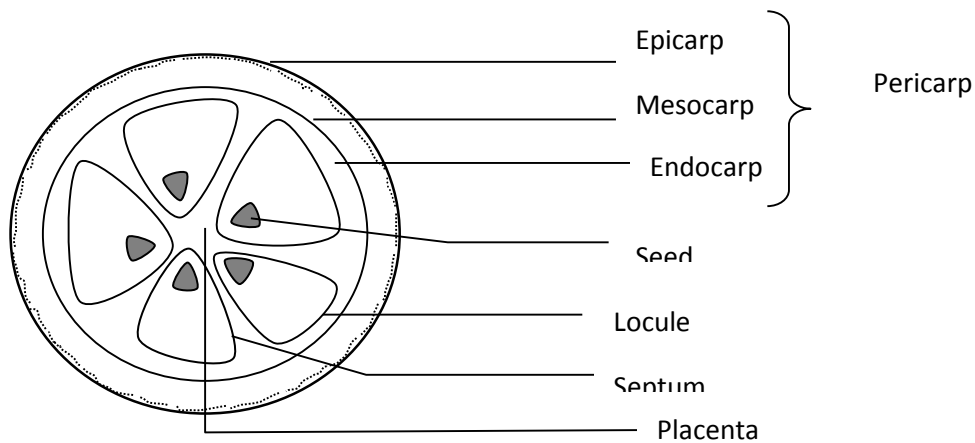

#### 3. Pome

This is a succulent fruit in which the outer fleshy (normally edible) part develops from the calyx and receptacle. The ovary forms a papery aore containing seeds e.g. apple and pears.

### PLACENTATION

This is the distribution of the placentae in the ovary or the arrangement of the seeds on the placenta within the ovary.

There are five types of placentation as shown in the table below.

<b>Type of Placentation</b>	<b>Description</b>	<b>Example</b>
Marginal	Ovules are situated at or near the margin of the ovary	Beans, peas, cassia
Axile	Ovules centrally located in the ovary with ovary divided into many chambers.	Orange and tomato
Central	Ovary is one chambered and ovules centrally located	Soap wort,
Parietal	Placenta is found on the inner wall of the fruit and the ovules are attached on the inner wall	Passion fruits pawpaw, cocoa
Free central	Ovules located on the projection from the base of a one chambered fruit	Green pepper
Basal	Ovule found on a placenta that arises from the base of the ovary, fruit usually single seeded	Mango, avocado.

### FRUIT/SEED DISPERSAL

This is the scattering or spreading/displacement of fruits and seeds from their parent plants. In some plants, only seeds are dispersed while in others, fruits are dispersed with seeds.

### **Importance of dispersal**

- i) It helps to prevent overcrowding among plants of the same species.
- ii) It reduces competition between member plants of the same species.
- iii) It helps to minimize the spread of epidemic diseases especially in seedlings if they are crowded.
- iv) It helps plants to colonize new areas which may even be better for the species survival.
- v) It enhances the chances of survival and continuity of the plant species.

### **Agents of dispersal**

They include;

- 1) Water,
- 2) Wind
- 3) Animals
- 4) Self-dispersal/ explosive mechanism

Fruits and seeds possess specialized structure to aid their dispersal and are adopted to specific mode of dispersal.

### **Characteristics of fruits/seeds dispersed by wind**

- i) They are usually small, light and dry which enables them to easily be carried or flown by wind.
- ii) Some fruits like elm and tecoma have wing like structures that increase their surface area. This helps in delaying the fall of seeds and fruits and increases chances of being blown away.
- iii) Some fruits like tridax and clancletion have parachute-like hairs called pappus which enables them to fleet and fly by wind.
- iv) Some seeds like silk cotton possess thread-like structures called floss which increase surface area enabling the seeds to float in air.
- v)

### **Characteristics of fruits/seeds dispersed by water**

- i) They are usually light and contain air space inside which reduces their relative density and enable them float on water easily like the coconut.
- ii)

### **Characteristics of fruits/seeds dispersed by animals**

- i) Some fruits such as tomatoes, oranges and mangoes are usually large and brightly coloured especially when ripe. This helps to attract animals.
- ii) Some fruits when ripe are scented e.g. jack fruit. This helps to lure/attract animals.
- iii) Some usually possess edible parts which are succulent / juicy and the only part of the fruit that is eaten and the rest containing the seeds is thrown away e.g. mango and avocado.
- iv) In some fruits, such as guavas, tomatoes, pepper and pawpaw. The whole fruit is eaten and the seed passed out in the faeces because of their resistance to digesting i.e. are indigestible.
- v) Some fruits e.g. *Biden pilosa* and *desmodium* possess hooks and sticks in the hair of passing animals. They stick in the fur of animals or on clothing of people.

### **Self-dispersal**

#### **a) explosive mechanism**

This happens with dry dehiscent fruits. The pericarp splits open along the sutures to release the seeds. This is made possible due to the tension that is built during the process of drying. E.g. legumes, capsule or follicles

#### **b) ribbon fruits**

These are succulent, may drop freely from the parent plant. The pericarp then rots, bearing the seeds that are enclosed within a hard protective testa so that it can begin germinating.

## **SEED GERMINATION**

This is the growth and development of an embryo of a seed into a seedling or a young plant under favorable conditions.

### **Types of germination**

#### **1. Epigeal germination**

This is where the cotyledons appear above the ground due to the rapid elongation of the hypocotyl e.g. beans, cotton, sun flower, etc.

#### **2. Hypogeal germination**

Is where the cotyledons remain below the ground and the radicle emerges due to elongation of the epicotyl e.g. maize, mango and black jack.

NB: During germination, the seed absorbs water mainly through the micropyle which makes the cotyledon swell and split the testa. This process is called imbibition. The radicle comes out of the testa faster followed by the plumule.

### **Conditions necessary for germination to occur**

#### **a) Environmental or external factors**

- i)** Water
- ii)** Oxygen
- iii)** Suitable temperature

#### **b) Internal conditions**

- i)** Viability of the seeds
- ii)** Amount of food in the seeds
- iii)** Enzymes
- iv)** Absence of germination inhibitors e.g. poison

### **1. Water**

Water is needed for the following:

- It activates the enzymes within the seed to hydrolyze the stored food.
- It makes the seed swell, soft and the testa to bursts.
- It dissolves the stored food.
- It is a medium in which all the chemical and enzymatic reactions proceed.
- It is a medium of transport of the dissolved food substances to the developing shoot and root of the new plant.
- Water is needed for the development of cell vacuoles. Large cell vacuoles contribute to increase in size of cells.

### **2. Oxygen**

Oxygen is necessary for the process of respiration, the oxidation of food to provide energy required for growth.

### **3. Warmth**

Suitable temperature is important for the enzyme controlled reactions in the cotyledon of the germinating seed. At low temperatures, the enzymes are inactive and at high temperatures, they are denatured hence no germination. Germination will require an optimum temperature which varies from 10°C-50°C for most tropical seeds.

## **EXPERIMENTS ON GERMINATION**

## An experiment to demonstrate the conditions necessary for germination

### Apparatus:

4 test tubes, Cotton wool, Seeds, Oil and Water.

### Procedure:

- Arrange four test tubes labeled 1-4
- To test tube 1 add moist cotton wool, seeds and leave test tube open.
- To test tube 2 add dry cotton wool, seeds and leave test tube open.
- To test tube 3 add seeds, boiled cooled water and a layer of oil.
- To 4 add seeds, moist cotton wool, ice and leave test tube open. Leave all test tubes for 3 days.

### Setup:

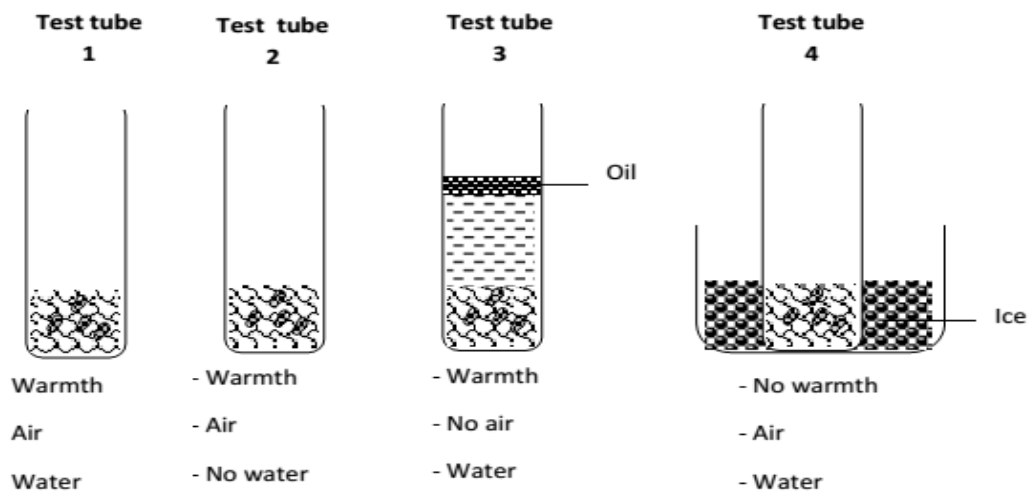

### Observations

Seeds germinated in only test tube 1 and those in 2, 3 and 4 did not germinate.

### Conclusion:

Air, water and warmth are necessary for germination.

## Experiment to show that oxygen is necessary for germination

### Apparatus:

2 conical flasks, 2 corks, Water, Cotton wool, Seeds and Pyrogallic acid.

### Procedure:

- ✓ 1. Pour some water in one conical flask and some alkaline pyrogallol in another conical flask.
- ✓ Tie some seeds in wet cotton wool and suspend the cotton wool in the flasks using a thread.
- ✓ Fix the threads using a cork.
- ✓ Leave the set up for three days

**Set up:**

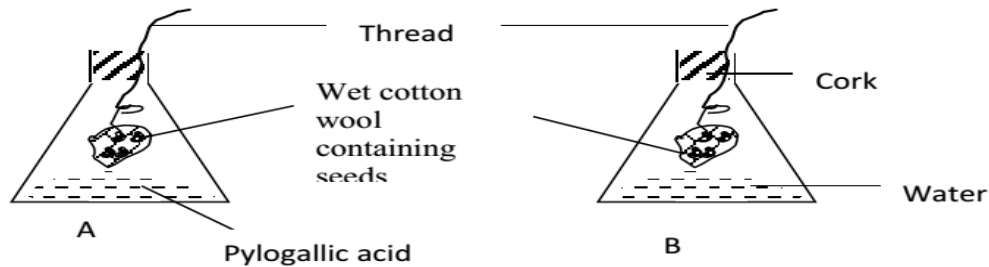

**Observation:**

After a few days the seeds in B germinated while those in A did not germinate.

**Conclusion:**

Oxygen is necessary for germination.

**Explanation:**

Alkaline pyrogallol absorbs oxygen from air in flask A thereby preventing germination.

**The graph showing the change in dry weight of a germinating seedling**

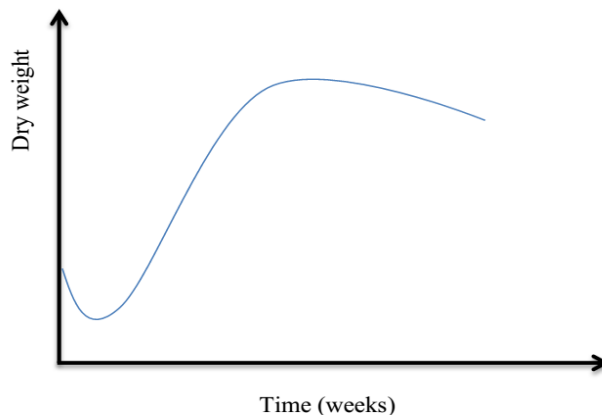

This is called the **sigmoid curve** (S shape) which is true for most organisms.

**Description:** Briefly the graph slows down at first and then increases rapidly reaching the maximum when it becomes constant for some time after which it begins to decrease gradually/slowly.

**Explanation:**

The decrease in dry mass is due to hydrolyzed food being oxidized to produce energy required for growth.

The dry mass increased gradually because this period growth proceeds slowly because the number of dividing cells is small. Then the dry mass increased rapidly because during this time the first green leaves appear and therefore carries out photosynthesis. As more leaves appear the amount of food manufactured during photosynthesis increases hence a rapid increase in the dry mass of the bean seedling.

The dry mass then increases gradually after a plant approaches its full size of development because most of the cells becomes differentiated and lose their power of cell division. This decreases the number of cells formed and hence decrease in the rate of growth.

The rate of growth then remains constant because the numbers of cells added are equal to the number of cells which are dying off.

The dry mass decreases after some time because the plant is in senescence stage where the numbers of cells added are less than the numbers of cells dying off. This results into a gradual decrease in dry mass until when a plant dies.

## **SEED DORMANCY**

Seed dormancy is the condition where by viable seeds fails to germinate under certain conditions or resting stage.

### **Causes of seed dormancy**

#### **1. Immature embryo of the seed**

This may cause dormancy in seed germination since the embryo may undergo development before germination occurs.

#### **2. Presence of germination inhibitors**

Some chemical substances like acids do not promote germination of seeds when present. They destroy the enzymes.

### 3. Extreme temperatures

These greatly affect the function of enzymes in the seed. High temperatures denature enzymes while low temperatures inactivate them.

### 4. Presence of hard impermeable seed coat

Some seeds have a strong seed coat that does not allow water and gases to enter the seeds. Without water and gases, germination will not take place.

5. Dryness of soil and lack of sufficient oxygen enough for seeds.

If oxygen is absent, seed respire anaerobically and obtain less energy. This will not allow seeds to germinate.

### Ways of breaking seed dormancy

1. Harvesting mature seeds. This involves allowing embryos in seeds to develop up to maturity for certain period called *after-ripening period*. This allows the seed to develop fully.
2. By providing growth promoters which deactivate germination inhibitors. These are chemical substances that can make inhibitors less active. They contain nutrients or hormones for proper growth.
3. By exposing seeds to a cool period or chilling to initiate germination. This is common method of breaking seed dormancy in cereals.
4. By providing suitable conditions of oxygen, temperature and moisture which favour germination.
5. Removing the hard seed coat by:
  - ✚ Soaking seeds in water to soften it.
  - ✚ Action of fire to burn away the seed coat.
  - ✚ Passing seeds through animal gut.
  - ✚ Churning seed coat in concentrated acids.
  - ✚ Physical removal of the seed coat by using the hand or pricking or by action of bacteria in the soil.

### Importance of seed dormancy

- i) It prevents seed germination in unfavorable conditions e.g. seeds dispersed in winter remain dormant in summer.
- ii) It improves the chances of seedling to grow to maturity during favourable conditions.
- iii) Dormant seeds can be stored for a long time and the seed dormancy can be broken by giving artificial conditions. This helps in their transportation.

- iv) It reduces the risk of seeds being frozen to death during unfavorable conditions.

## **THE SOIL**

**Soil** is finely divided material covering the earth crust or surface. It consists of air, water, humus, living organisms, and weathered rocks.

### **Importance of soil**

- Soil provides nutrients e.g. water and minerals to plants which are the chief producers of food in the environment.
- Soil is a habitat (home) for many organisms such as earth worms, termites, bacteria fungi and arthropods.
- Soil provides a medium through which man and all other animals dispose of their wastes.
- Soil is an important natural resource which provides construction materials, supports agriculture, craft and art materials.

## **SOIL FORMATION**

soil is formed from parent rocks by the process of weathering. This occurs over several years. The process of weathering takes place in three ways;

### **1. Physical weathering:**

This occurs in the following ways;

- i) Alternate heating and cooling of the rocks on exposed mountain sides, causes expansion and contraction which cause the rock to crack and break up.
- ii) By water; this is where rivers and streams wear away the rocks over which they flow by rolling pebbles and other hard particles on them.
- iii) During sandstorm when wind blows sand against bare rocks
- iv) Frosting: frost is weather condition where temperatures fall below 0°C, water in cracks freezes and expand, causing the rock to break up.

### **2. Chemical weathering:**

This is brought about mainly by the action of water especially rain water on the rocks. As it rains, rain dissolves carbon dioxide in the atmosphere to form weak solution of carbonic acid which when falls on soft rocks for example lime, it dissolves them, this results in the release of mineral elements like calcium, magnesium, Aluminium, etc. which are components of soil.

In hot damp conditions (tropics) the constituency of rocks especially those containing iron, oxidizes very quickly. The oxidized rocks disintegrate to form soil.

### **3. Biological weathering:**

This is brought about by the action and presence of living organisms on rocks. Certain organisms such as lichens are able to grow on bare rock while other small flowering plants are able to grow between the rock fragments. When these die, they form humus which is a component of soil.

Man contributes to biological weathering through direct splitting of rocks during road and house construction and indirectly through cultivation.

## **FACTORS INFLUENCING SOIL FORMATION**

There are 5 major factors influencing soil formation:

- Climate
- Living organisms
- Nature of soil parent material
- Topography of the area
- Time that the parent rock material is subjected to soil formation.

### **i) Climate**

The main climatic factors involved in the soil formation are rainfall, temperature and wind.

Rainfall and temperature influence the chemical and physical break down of the parent rock e.g. rainfall promotes weathering of rocks into small particles by leaching of soluble constituent compound in the rock.

### **ii) Living organisms**

These include the vegetation cover, living microorganisms (bacteria and fungi) and invertebrates e.g. earth worms. The vegetation cover influences the characteristics of the soil formed through the litter and roots remains which add to the soil.

The termites feed on dead vegetation there by decomposing it. The bi-products of decomposition are added into the soil.

### **iii) Parent rock**

This influences physical properties and chemical constituents of the soil e.g. granite and sand stones which are rich in mineral content giving rise to sand soil while volcanic larva produces clay soils.

### **iv) Topography**

It influences the movement of products of weathering which consist of soluble substances and solid soil particles.

It affects soil depth and vegetation thus on a steep or rolling topography there is a tendency for soil erosion to occur with a result that relatively shallow soils develop. Therefore it modifies the effects of soil climate and vegetation on soil formation.

#### v) Time

The length of time over which soil forming processes have been in action affects the age of the soil. When soils forming have taken place for a long time, one tends to get deep mature soils, provided other factors are constant.

### SOIL PROFILE

*This is the vertical arrangement of the various soil layers called horizons.* It represents the different layers at various stages of soil development. A soil with distinguished soil layers is known as mature and that without clear profile is immature or young. The profile consists of the following:

- i) Top soil
- ii) Sub soil
- iii) Parent or underlying rock

#### Diagram to show the soil profile

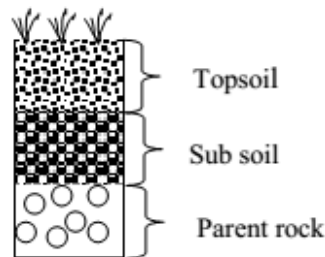

#### 1) Horizon A – Top soil

This is the upper most soil layer. It's usually about 20cm deep and is the most important horizon that supports the growth of plants. It has got the following characteristics:

- It's usually better aerated
- It has more active soil microorganisms
- It contains humus so it's usually dark in colour.
- It contains more plant root and usually litter.

#### 2) Horizon B – Sub soil

This is a thicker light brown layer lying immediately below the top soil. It's composed of mainly rock fragments, clay and gravel. It has the following characteristics:

- It is less aerated than top soil.
- It contains only deep roots of plants and hardly any other organism.
- It contains very little or no humus
- It tends to contain a lot of mineral salts due to leaching and therefore referred to as the layer of accumulation.

### 3) Horizon C – Parent rock

This is a solid rock layer found below the sub soil. It represents the original parent material which is still intact and unweathered.

The common parent rocks in East Africa are granites, volcanic and sedimentary rocks. This horizon lack humus completely. It has low air content and mineral salts.

## COMPONENTS OF SOIL

There are basically six components of soil. These are:

- i) Inorganic particles,
- ii) Humus,
- iii) Water,
- iv) Air,
- v) Mineral salts, and
- vi) Soil living organisms.

### 1. INORGANIC PARTICLES

These are produced during the process of weathering. Soil particle vary in size and their sizes are used to classify them. The different soil particles are clay, silt, fine sand, coarse sand and gravel.

**Table showing sizes of soil of particles**

Soil particle	Diameter (mm)
Gravel	> 2.0
Coarse	0.2– 2.0
Fine sand	0.02 – 0.2
Silt	0.002 – 0.02
Clay	< 0.002

### Uses of soil particles

- i) They provide a surface for anchoring plant roots hence providing support to the plants.
- ii) Soil particles give a rigid frame work to the soil.
- iii) They provide mineral elements to the soil which are the absorbed by plants using roots.

### Experiment to show the soil texture of topsoil

#### Apparatus/materials:

Measuring cylinder, Top soil, Stirrer, Beaker

#### Procedure:

Put water in a measuring cylinder half way. Pour soil ( $20\text{cm}^3$ ) in water and stir thoroughly. Leave the experiment to stand for 3 minutes and observe.

#### Observation

When the soil particles settle down, the particles arrange themselves according to their particle size where the heaviest settle at the bottom and the small and lightest at the top as shown above.

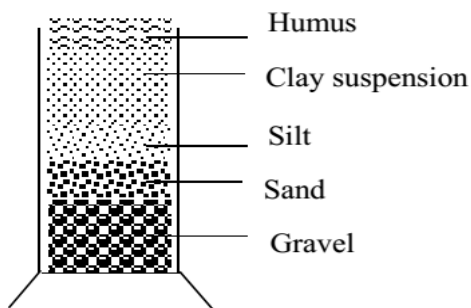

#### Conclusion

Soil is made up of different particles, which have varying sizes and densities.

## 2. SOIL AIR

**Soil air** exists between the soil particles. Airspaces in the soil are important for growth of plant roots and health of soil organisms. It is mainly oxygen and nitrogen. (Carbon dioxide is usually in solution as carbonic acid). The depth to

which the roots can grow depends on how deep the air can penetrate through the soil

### **Importance of soil air**

- It provides oxygen for respiration of soil organisms and plant roots.
- Oxygen is also needed for the decay that produces humus.
- It also provides nitrogen for fixation by the nitrogen-fixing bacteria in the soil. The nitrogen absorbed is needed in the formation of nitrates and proteins.
- Carbon dioxide present in the air helps in increasing soil acidity which favours proper growth of some plants.
- Carbon dioxide present in the air dissolves in water to form carbonic acid for weathering.

## **EXPERIMENT TO DETERMINE THE PERCENTAGE OF AIR IN THE SOIL**

### **Apparatus**

Measuring cylinders (2)

Dry soil sample

Water

Glass rod

### **Method**

1. Measure about 50cc of dry soil in a measuring cylinder and tap the container to level out the soil.
2. Measure 50 cc of water in another measuring cylinder.
3. Add the two together (observe carefully as you pour the water onto the soil)
4. Allow the mixture to stand until no more bubbles appear. Read and record the final level of water plus soil in the measuring cylinder.
5. Calculate the air content in terms of percentage.

### **Example**

Volume of soil = 50cc

Volume of water = 50cc

Final volume of water + soil after mixing = 85cc

Volume of air in soil (100-85)= 15cc

Percentage of air in soil sample=  $\frac{\text{vol of air in soil}}{\text{vol of soil used}} \times 100\%$

### **3. WATER**

Soil water comes from rain. Also some rise up from the ground water by capillary action to replace water lost by evaporation from the surface. It is found as a thin film surrounding the soil particles.

#### **Soil water has the following functions**

- i) It moistens soil and keeps it humid/moist, making it favorable for survival of micro-organisms.
- ii) It dissolves mineral salts making them available for plants to take.
- iii) It dissolves carbon dioxide produced by living organisms to form carbonic acid which causes chemical weathering of rocks.
- iv) It is a raw material for photosynthesis.
- v) Water absorbed from the soil allows plant cells to be rigid (turgid), and this is very important for support of the plant, particularly herbaceous plants.

#### **EXPERIMENT TO DETERMINE THE PERCENTAGE OF WATER IN A SOIL SAMPLE**

##### **Apparatus:**

Evaporating dish or basin, fresh soil, weighing scale and oven or Bunsen burner.

##### **Procedure:**

- a) Weigh a clean evaporating dish and record its weigh. (Let the weight be X g).
- b) Fill the evaporating dish with soil and record the weight of the soil plus the evaporating dish. (Let the weight be Y g).
- c) Dry the soil by heating it gently over a Bunsen burner flame for about 30 min.
- d) Heating and weighing is repeated until a constant mass is achieved. (Take care not to burn the soil (no smoke))
- e) Re-weigh the soil and the evaporating dish. (Let it be Z g).
- f) Then calculate the water content in the soil sample as shown below;

##### **Note:**

You should cool in a desiccator before weighing. This ensures that no fresh vapour enters the soil.

##### **Results:**

Weight of the evaporating dish = X

Weight of soil + evaporating dish = Y

Weight of soil + evaporating dish after heating = Z

Weight of soil sample = Y-X

Weight of water in the soil sample = Y-Z

$\% \text{age of water} = \frac{\text{weight of water}}{\text{Weight of soil}} \times 100$

Therefore percentage of water =  $\frac{(Y-Z) \times 100}{Y-Z}$

#### 4. HUMUS

**Humus** is decaying plant and animal material- the dead bodies of animals, fallen leaves, dead plants and animal droppings. It is a dark brown, rather sticky material that gives soil its dark colour. For the decay process that form humus to work properly plenty of oxygen is needed.

##### **Importance of humus**

- i) Because humus is dark-coloured, soil rich in humus absorbs more heat, and this warmth is useful for the germination of seeds and helps to speed up decomposition, making more humus.
- ii) It has a high absorptive capacity for water.
- iii) It forms a sticky coat around soil particles and binds several together to form soil clumps. The clumps structure greatly improves the drainage of the soil.
- iv) Humus retains moisture and minerals in the top soil and so, greatly reduces the effects of drying and leaching (washing of minerals).
- v) It is a source of nutrients used by plants after it is decomposed.
- vi) It improves soil aeration.
- vii) It improves soil structure by reducing the sticky properties of clay.
- viii) It stabilizes soil pH.
- ix) It leads to improvement of activities of soil organisms by providing them with food and shelter.
- x) It insulates soil against extreme heat and cold temperatures changes.

#### **EXPERIMENT TO DETERMINE THE PERCENTAGE OF HUMUS (ORGANIC MATTER) IN THE SOIL**

##### **Apparatus:**

Crucible, soil sample, weighing scale, heat source, wire, tripod stand, pipe clay triangle

##### **Procedure:**

- a) Weigh a clean empty crucible and record its weight (W g).
- b) Half fill the crucible with soil and record the exact weight of soil plus crucible on weighing scale (X g).
- c) Dry the soil by heating it in an oven at 105<sup>0</sup>C to constant weight (Y g) (the loss in weight of soil at this temperature is due to the water driven out by evaporation)
- d) Reweigh the soil and crucible and record the weight.
- e) Heat the dried soil on a crucible to redness in an oven.
- f) Weigh the soil after cooling and record its weight.
- g) Repeat this till a constant weight is achieved (Z g).

**Results:**

Weight of crucible = W g

Weight of crucible + fresh soil = X g

Constant weight of soil + crucible after heating at 105<sup>0</sup>C = Y g

Constant weight of soil + crucible after heating after heating to redness = Z g

Weight of soil = X - W

Weight of dry soil = Y - W

Weight of dry soil after burning off humus = Z - P

Weight of humus = Y - Z g

Percentage of humus =  $\frac{\text{weight of humus}}{\text{Weight of soil}} \times 100\%$

$$\text{Percentage of humus} = \frac{(Y-Z) \times 100\%}{X - W}$$

**Exercise**

The following experiment was done to find out the percentage of humus in a given soil sample. The soil sample weighing 120g was heated in an oven kept at 100° C. The dry soil weighed 112g. The soil was then heated slowly to burn away humus. The weight of soil after all humus had burnt was 106g

- a) Why was the soil not heated properly at first?
- b) What was the weight of humus in the soil?
- c) Calculate the percentage of humus in the soil.
- d) How many times was water more than humus?

**Solution:**

a) It was not because it will burn the humus containing water

b) Weight of soil after burning humus = 106g

Weight of dry soil = 112g

$$\begin{aligned}\text{Weight of humus} &= (112 - 106) \\ &= 6 \text{ g}\end{aligned}$$

$$\begin{aligned}\text{c) Percentage of humus} &= \frac{6}{20} \times 100 \\ &= 5\%\end{aligned}$$

## 5. MINERAL SALTS

These are chemical elements in form of ions, dissolved in the film of water, surrounding the soil particle.

Some of the mineral elements in soil are; Sulphur, phosphorous, nitrogen, silicon, magnesium, iron and Aluminium ions which results from weathering of rocks.

## 6. SOIL LIVING ORGANISMS

### a) Micro organisms

They include bacteria and fungi. They play an important part in maintaining soil fertility through decomposition of plant and animal remains nitrifying bacteria convert nitrogen into nitrates thus making it available to plants.

### b) Macro organisms.

They include roots of higher plants, earth worms, nematodes e.g. ascaris, hookworms, filarial worm, and soil arthropods.

Earth worms are common in moist soils rich in humus. They dislike dry or acidic soils. They tunnel into the soil by force, thus improving the soil aeration and drainage.

### Importance of living organisms

- i) They improve fertility of the soil through fixing atmospheric nitrogen by nitrogen fixing bacteria and decomposing litter and other wastes into humus carried out by termites and bacteria.
- ii) Some living organisms like earth worms burrow in the soil and this improve soil aeration and drainage.
- iii) Some living organisms in soil cause diseases to man and his plants.
- iv) Wastes from soil living organisms add fertility to the soil.

## EXPERIMENT TO INVESTIGATE THE PRESENCE OF LIVING ORGANISMS IN SOIL

### Apparatus

Two test tubes  
Muslin bag  
Top soil  
Two corks  
Lime water/ bicarbonate indicator solution

### **Procedure**

- i) Collect a hand full of fresh top soil and divide it into 2 equal portions.
- ii) Sterilize one portion of the soil sample by heating it strongly on a crucible for 30 minutes. Leave it to cool and place it in a muslin bag.
- iii) Place the remaining portion of the fresh soil sample in another muslin bag.
- iv) Add equal amounts of lime water or bicarbonate indicator in the test tubes and then suspend the muslin bags with soil in the test tubes as shown in the set up below.

Allow the test tubes to stand for about 2 days and observe the appearance of lime water or bicarbonate solution.

### **Observation**

Lime water turns milky or the bicarbonate indicator solution turns yellow in test tube A but remains clear in test tube B.

### **Conclusion**

Carbon dioxide was produced in test tube A during respiration indicating the presence of living organisms.

Lime water remained clear in test tube B because the living organisms in soil in test tube B were killed by heating

### **ALTERNATIVE EXPERIMENT**

The experiment is set up as shown below;

The setup is left to stand for about 2 days and any changes in the water level in the U-tube are observed.

#### **Observation**

Water level in the u-tube increases in the left arm and decreases in the right arm. This is due to oxygen in the air inside conical flask A being absorbed by the living organisms in the soil causing reduced pressure in conical flask A hence the raised pressure of the remaining gases in conical flask B causing water to raise in the left arm of the u-tube.

### **TYPES OF SOIL**

Soil is grouped basing on size and nature of soil particles. On this basis, there are 3 main types of soil namely:

Clay soil

Loam soil

Sand soil

#### **1. Sandy soils;**

- Sandy soils contain large space between the particles and these spaces allow water to drain off very quickly.

- They have a gritty feel when wet and felt between the thumb and figure.
- They contain only very small quantities of water and they may be deficient in calcium and magnesium
- They are described as light soils because they are relatively easy to work with.

## 2. Clay soil:

- They have small fine particles i.e. fine texture.
- The soil particles in clay are closely parked together leaving very small spaces between them. This causes clay soils to have poor water drainage and also become water logged.
- They are difficult to work with and therefore described as heavy soils.
- They have a sticky feel when wet.

## 3. Loam soil:

This is a mixture of sand (about40%), silt (about40%), clay (15%), organic matter (1-4%) it has stable crumb structure and is the best for crop production.

### Differences between clay and sand soil

Clay soil	Sand soil
1. Very small air spaces between particles	Large air spaces between particles
2. Rich in dissolved salts	Poorly dissolved salts
3. Has high water retention capacity	Has only very low water retaining capacity
4. Poor drainage i.e. low permeability	Very easy drainage i.e. high permeability
5. Water can rise to high level by capillarity	Water cannot rise to high level by capillarity
6. More than 30% clay and less than 40% sand	More than 70% sand and less than 20% clay

### PHYSICAL PROPERTIES OF SOIL

#### 1. Porosity:

Sandy soil possess large spaces between the soil particles and so more porous.

Clay soils possess very small spaces between the soil particles thus less porous.

Loam soil is moderately porous.

#### 2. Air content:

Sand contains a lot of air so it is well aerated. This is because it has large spaces existing between the particles.

Clay soil contains little air so it is poorly aerated due to presence of small spaces between the particles.

Loam soil has varying amounts of air.

### **3. Drainage of water:**

Sand has good water drainage so it allows water to pass through it very quickly.

Clay soil has poor drainage of water and this makes clay water logged. This can be improved by adding humus to it.

Loam drains water moderately.

### **4. Water retention capacity:**

This refers to the amount of water soil can hold. Sand soil holds little water so it has a poor water retention capacity. It can be improved by adding humus to it. Humus sticks sand particles together.

Clay soil tends to become water logged i.e. it holds a lot of water so has a high water retention capacity.

Loam soil holds water moderately but not becoming water logged.

## **EXPERIMENT TO COMPARE THE DRAINAGE AND RETENTION OF WATER IN SAND AND CLAY SOILS**

### **Apparatus**

2 filter funnels,

2 measuring cylinders,

2 filter papers

Equal volumes of samples of dry sand and dry clay soils,

Water and

Beakers

### **Procedure**

- a) Measure an equal volume of each soil sample.
- b) Fold filter papers properly and put one in each funnel.
- c) Then place clay soil in the filter paper in one funnel and the sand in the other funnel.

- d) Place the funnels with their contents over measuring cylinders and at the same time pour an equal volume of water on each of the soil samples as shown in the diagrams.

### Setup:

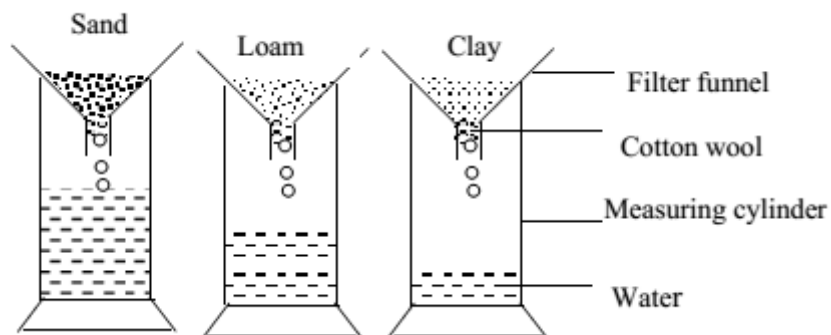

Observe which soil allows water to drain through quickly.

Allow the set up to stand for some time till water stops draining through the soils.

### Observation

Water passes through sand soil faster than clay soil. So much water is collected in the cylinder with sand soil and less water is collected in the cylinder containing clay soil.

### Conclusion

Clay soil holds more water than sand soil and sand soils drains water faster than clay.

### Explanation

Sand soil has larger air spaces which enable water to drain through more rapidly and on the other hand clay soil retains more water than sand because it has many small particles which can hold more water.

### 5. Water capillarity through different soils:

Capillarity through soil means how well water can rise up in the soil and this depends on the size of air spaces between the soil particles.

Sand soil has the lowest capillarity of water while clay soil has the highest water capillarity and loam soil has medium water capillarity.

## **EXPERIMENT TO DEMONSTRATE AND COMPARE WATER CAPILLARITY THROUGH SAND, CLAY AND LOAM SOIL**

### **Materials**

- 3 long glass tubes
- Glass troughs
- Muslin bags and threads
- 3 retort stands and clamps
- 3 samples of dry sand, clay and loam soils.

### **Procedure**

- Tie a muslin sheath tightly at the end of the glass tubes.
- Fill one glass tube with dry sample of sand soil and pack it well ensuring that there are no spaces in the soil.
- Repeat this with clay and loam soils.
- The glass tubes are stood vertically with the ends tied with muslin sheath immersed in a glass trough containing enough water.
- The glass tubes are supported upright with retort stands and clamps as shown in the diagram below.

Setup

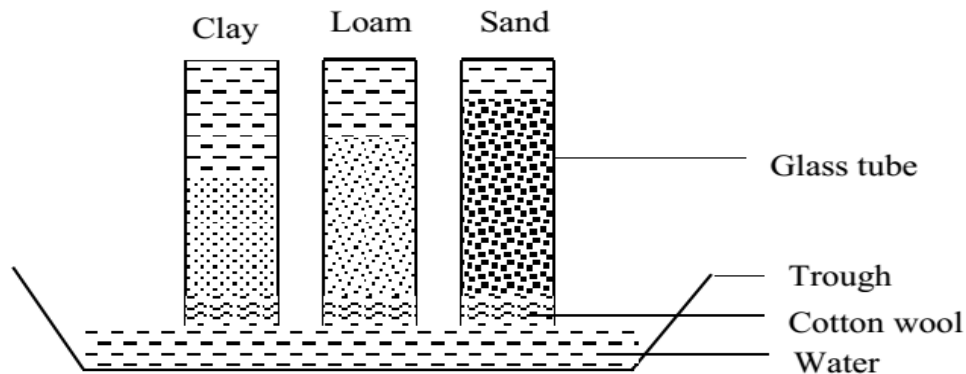

### **Observation**

Water rises faster for a short distance in sand soil while in clay soil water rises slowly but to higher distances. In loam soil, water rises moderately to a moderate distance.

### **Conclusion**

Clay soil has the highest capillarity of water.

Sand soil has the lowest capillarity while loam has moderate water capillarity.

### **Explanation**

Water rises to the greatest height at the nearest stages of the experiment in sand soil because sand has large spaces that enable water to rise more rapidly in the first hours.

Clay soil shows the highest rise of water hence the highest water capillarity because it is composed of tiny soil particles which present the large surface area over which water molecules cling.

Water rises at a slow rate in clay soil because clay has small air spaces between its particles.

## **CHEMICAL PROPERTIES OF SOIL**

### **1. Soil colour**

This determines the amount of heat that can be trapped in a soil sample. Dark soils retain heat more than light soils.

### **2. Soil pH**

This is the degree of acidity or alkalinity of the soil. Most soils in the tropics are acidic but some are alkaline. Soil pH affects the rate at which mineral salts e.g. nitrogen, phosphorous, iron are absorbed by plant roots. Most plants grow best in slightly acidic or neutral soil.

## **EXPERIMENT TO DETERMINE THE SOIL PH**

### **Materials**

Soil

Petri dish

Universal indicator

Indicator chart

### **Procedure**

- a) Place about 3g of soil on a Petri dish and soak it with universal indicator. Leave for 2-3 minutes.
- b) Tilt the Petri dish so that the indicator drains out of the soil.
- c) Compare the indicator color with the indicator chart.

### **Alternatively:**

- a) Soak the soil sample with distilled water.

- b) Drain off/ filter off and test with universal indicator solution or universal indicator papers.

## **SOIL EROSION**

This is the removal or washing away of top soil by animals, wind or running water. The extent of soil erosion is dependent upon the intensity with which the rain falls and not the amount of water.

### **Types of soil erosion**

#### **Sheet erosion**

This is where thin uniform layers of soil are eroded over the whole slope.

#### **Rill erosion**

This is where water cuts shallow channels called rills. The channels deepen as volume of water run off increases.

#### **Gulley erosion**

This results from rill erosion when the channels deepen and form gulleys. Here a lot of soil is carried away over greater distances. It is facilitated by careless ploughing (up & down the slope). It may follow tracks made by vehicles and from animals.

#### **Splash erosion or raindrop erosion**

This occurs when intense raindrops displace soil.

#### **Wind erosion**

In dry conditions, herds of farm animals trample and compact the soil, causing a layer of dust on top. When wind comes, it can blow away the dust.

### **CAUSES OF SOIL EROSION**

#### **1) Slopes of land**

The deeper the slope the greater the erosion and this is coupled with the intensity of rain.

#### **2) Over grazing**

This is caused by the keeping of many grazing animals on a small area. They finish the grass, i.e. remove the grass cover and open it to water erosion. They trample the soil and make it dusty, thus erosion can take place.

#### **3) Deforestation**

Foliage of trees reduces intensity at which raindrops reach the ground. Extensive falling of trees in an area removes this cover thus facilitating erosion on slopes.

#### **4) Bush burning**

Uncontrolled burning of bushes in dry seasons removes the grass top cover, thus leaving the soil bare for erosion.

#### **5) Poor farming methods:**

**Ploughing:** It lessens the soil and destroys its natural structure. Failure to replace humus after successive crops reduces water holding properties, so soil dries easily and can easily be blown away.

Ploughing up and down a slope accelerates water erosion.

**Over cropping;** over use of soil depletes fertility, thus causing loss of plant cover. This leaves the soil bare and so susceptible to erosion.

### **Methods of reducing (preventing) soil erosion**

#### **a) Contour ploughing**

Ploughing a long contours i.e. across a slope and not up and down. It allows furrows to trap water rather than to channel it a way.

#### **b) Strip cropping**

This consists of alternate bands of cultivated and uncultivated soil, following contours. Un tilled soil is covered with grass.

By alternating the grass and crops each year, the soil is allowed to rebuild its structure while under grass.

#### **c) Terracing**

This is cultivation a long contours in horizontal strips supported by stones or walls, so breaking up the steep down water rush of the surface run-off. The steeper the slope, the closer the terraces must be.

#### **d) Correct crop for soil**

Steep slopes which should not be ploughed are covered with pasture crops, their roots hold the soil

#### **e) Afforestation**

This is the Planting large areas of land with trees. They act as wind brakes, hold the soil together, and prevent raindrops from hitting the soil directly

They conserve water and control flooding.

#### **f) Mulching**

covering of top soil with plant material e.g. banana leaves, maize stems after harvest, cut grass etc. it protects the top soil and conserves the water in the soil.

### **Effects of soil erosion (to farmers)**

- Nutrients and soil organisms are carried away in the top soil.
- The soil left behind is unproductive.
- Fields may be cut into irregular pieces by rill and gully erosion
- Floods carry away or submerge and suffocate crops and soil organisms.

## **SOIL FERTILITY AND CONSERVATION**

### **SOIL FERTILITY**

Soil fertility refers to the amount of nutrients in the soil that can support the growth of plants. Soil can lose its fertility through the following ways.

1. **Soil erosion.**
2. **Leaching;** this is the washing down of soluble minerals from topsoil layers to bottom layers where they cannot be accessed by plants.
3. **Soil exhaustion;** this is the depletion/reduction in soil nutrients as a result of monoculture, over cropping, etc.
4. **Soil compaction;** this is the hardening of soil on the surface due to action of heavy machinery, movement of animals and man on soil, etc. Soil compaction prevents water from penetrating into the soil.

### **SOIL CONSERVATION**

This is the protection and careful management of soil to maintain its fertility. It includes methods of controlling erosion and others such as:

#### **Intercropping**

Here, plants are alternately planted in a systematic or even random manner e.g. coffee, beans, and banana can be intercropped.

#### **Fallowing**

Land is left to rest and grow back to bush.

#### **Crop rotation**

The farmer carefully rotates his crops season after season, so that the plants make different demands on the soil.

Deep rooted crops like cassava are rotated with shallow rooted ones e.g. g. nuts

### **Application of manure (organic manure)**

#### **1) Green manure;**

These are green plants, mostly legumes which can be dug back into the soil. However, any available green plants can do.

## **2) Farm yard manure;**

This is from wastes of farm animals like urine and faeces when left become manure. This improves the process of nitrification (addition of nitrates to the soil) e.g. poultry dropping, goats, pigs, cows etc.

## **3) Compost manure;**

This is made by collecting all available organic materials like chicken waste, weeds, fresh leaves into a pit with alternating layers of soil, and leaving them to rot. Water is added periodically to keep it moist for bacteria and fungi in the soil speed up the process. When well decayed, the compost is spread over the garden. Organic manure adds humus to the soil and maintains the crumb

Structure

## **4) Artificial fertilizers;**

These are added directly. The most common element lacking in highly cultivated soils are nitrogen, phosphorus and potassium. They are supplied in form of  $K_2SO_4$ ,  $(NH_4)_2SO_4$  and calcium phosphate which lead to high yield.

## **THE NITROGEN CYCLE**

Nitrogen is one of the elements that make up proteins. Nitrogen makes up to 80% of air but it is unreactive so cannot be used by plants and animals in its elemental form. It becomes part of the bodies of organisms in a process called the nitrogen cycle. The changing of nitrogen into more reactive forms is called nitrogen fixation.

Nitrogen fixation takes place during lightening, in the manufacture of artificial fertilizers and in the metabolism of the nitrifying and nitrogen fixing bacteria.

Plants absorb nitrogen as ammonium salts or nitrates.

Animals obtain nitrogen they need by eating plants or other animals that have eaten plants

At death or by leaf fall, egestion, excretion (urine), the nitrogen of plants and animals is returned to the soil

Nitrogen is in constant circulation between autotrophs, heterotrophs, and the soil in atmosphere

Plants absorb nitrogen in form of nitrates and ammonium salts, for manufacture/build up of proteins they require.

At death or by leaf fall, egestion, excretion (urine), the nitrogen of plants and animals is returned to the soil.

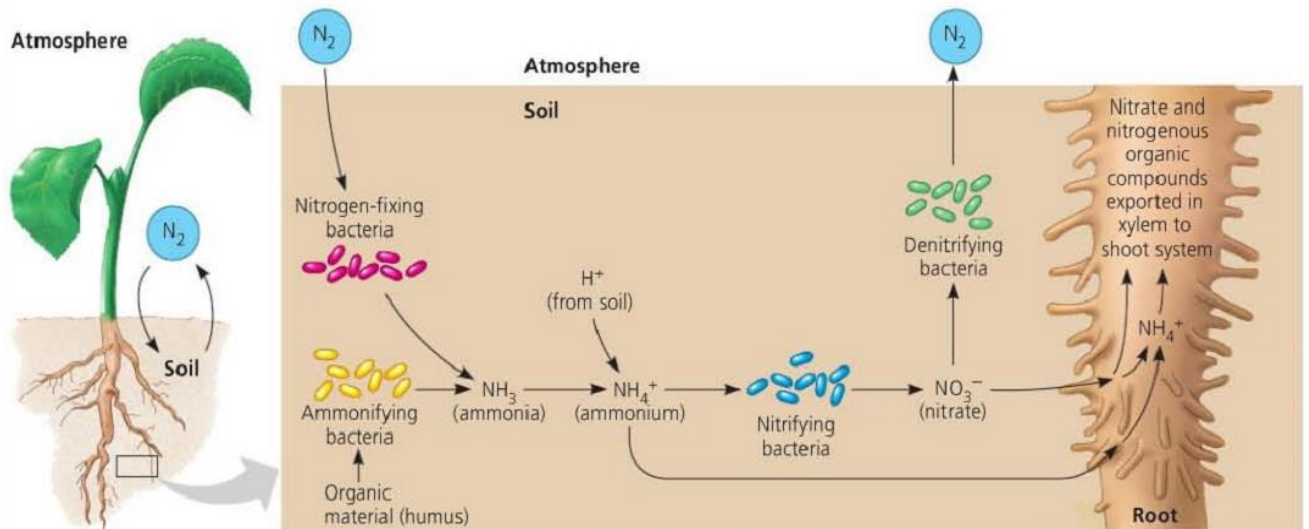
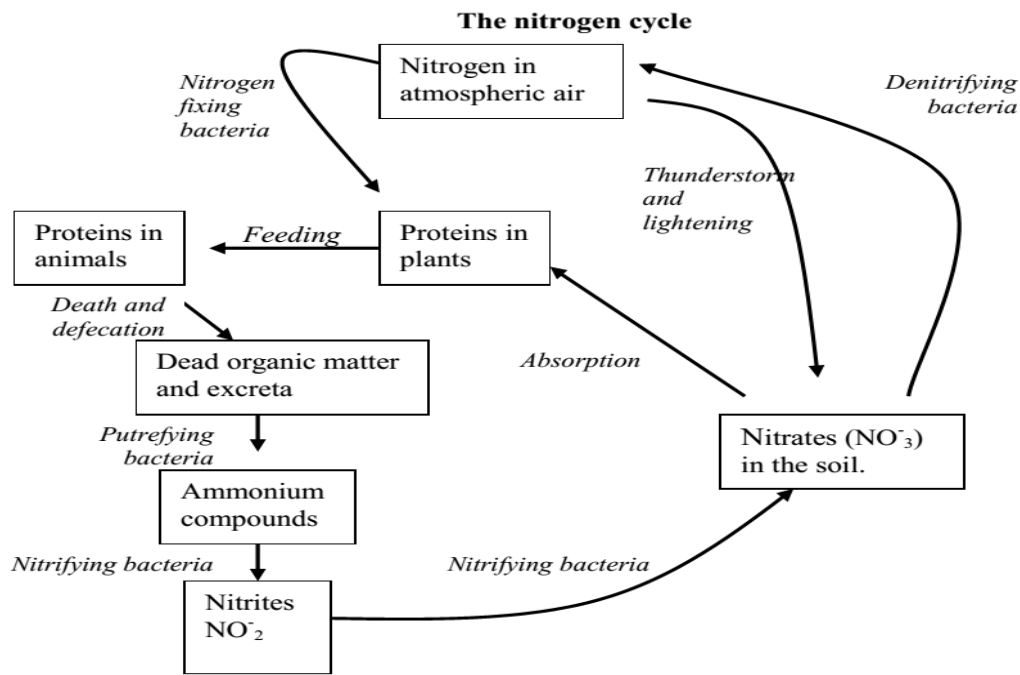

▲ **Figure 37.9 The roles of soil bacteria in the nitrogen nutrition of plants.**

Ammonium is made available to plants by two types of soil bacteria: those that fix atmospheric

$N_2$  (nitrogen-fixing bacteria) and those that decompose organic material (ammonifying bacteria). Although plants absorb some ammonium from the soil, they absorb mainly

nitrate, which is produced from ammonium by nitrifying bacteria. Plants reduce nitrate back to ammonium before incorporating the nitrogen into organic compounds.

## THE CARBON CYCLE

Carbon is an element which occurs in all elements that make up a living organism. Carbon is therefore a major component of all organic matter. Plants get carbon from the atmosphere in the air during the process of photosynthesis. Plants use carbon to make food like starch. Starch is eaten by animals to get energy.

When animals die, they decay and release the carbon and other nutrients in the soil. The circulation of carbon in nature from the atmosphere into the living organisms and back into the atmosphere forms the carbon cycle.

### The cycle

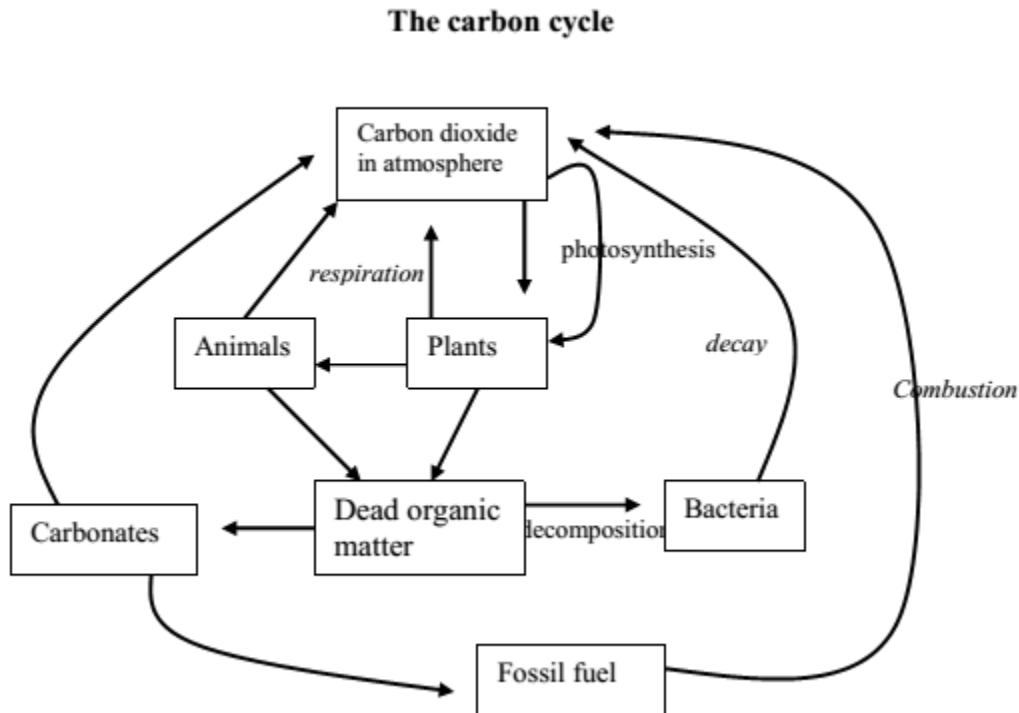

### Removal of CO<sub>2</sub> from the atmosphere:

Green plants remove CO<sub>2</sub> into the atmosphere during the process of photosynthesis.

Some of the CO<sub>2</sub> in the atmosphere dissolves in rain water to form carbonic acid. This acid reacts with soil mineral salts to form carbonates.

### Addition of CO<sub>2</sub> in the atmosphere:

a) Combustion (burning)

When carbon containing fuels e.g. petroleum, coal, natural gas, fire wood are burnt, CO<sub>2</sub> is released into the atmosphere. Formation of such fuels over millions of years is referred to as fossilisation.

b) Respiration in animals and plants.

c) Decomposition of organic matter by bacteria and fungi. During this process, CO<sub>2</sub> is released into the atmosphere.

## **NUTRITION**

Nutrition refers to the process by which living organisms obtain, consume and use food substances to maintain their life processes (metabolic processes).

These food substances are called nutrients.

These nutrients in green plants include; water, mineral salts, carbon dioxide and in animals include; carbohydrates, proteins, lipids, etc.

### **Modes of nutrition**

Nutrition is broadly classified into two groups namely;

14. Heterotrophic nutrition (nourishment on others).

15. Autotrophic nutrition (self-nourishment).

### **1. AUTOTROPHIC NUTRITION**

This is a mode of nutrition where by an organism is able to synthesize its own food from inorganic nutrients using some external source of energy. Such organisms are called Autotrophs.

Since the nutrition of all other organisms depends either directly or indirectly on these Autotrophs, they are referred to as producers.

Autotrophic nutrition can be divided into two depending on the external source of energy used to drive these processes;

#### **i. Photosynthesis:**

This is the type of nutrition where organisms make food with the help of sunlight energy. Examples include; green plants, algae, photosynthetic bacteria.

#### **ii. Chemosynthesis:**

This is where organisms make their own food with the help of energy from specific chemical reactions (oxidation of various inorganic compounds). Examples include; chemosynthetic bacteria.

### **2. HETEROTROPHISM / HETEROTROPHIC NUTRITION**

This is the mode of nutrition where by organisms obtain their food by feeding on already manufactured organic (food) compounds.

Heterotrophs are incapable of making their own food.

They include; all animals, fungi, insectivorous plants and most bacteria.

**Heterotrophic nutrition is of 5 major types, which include:**

#### **1. Parasitism**

This is an association between two living organisms of different species in which one organism (parasite) obtains food and shelter from the other organism (host) which instead suffers injury and harm. For examples;

- ❖ A tape worm in the gut of man
- ❖ A cow and a tick.
- ❖ A bedbug and a man.

## **2. Phagocytosis:**

This is the process of nutrition where simple cells or unicellular organisms engulf solid food particles. For examples;

- ❖ Amoeba.
- ❖ White blood cells.

## **3. Saprophytic/saprotrophic nutrition:**

Saprotrophic nutrition is a mode of heterotrophic nutrition where an organism feeds on dead decaying matter where by they absorb solutions from this dead decaying matter.

Saprotrophs lack chlorophyll and thus cannot make their own food. Examples include; Mushrooms, mucor, common bread mould.

## **4. Symbiosis / Mutualism;**

This is a nutritional relationship between two organisms of different species where both organisms benefit. However, only one organism benefits nutritionally.

### **Examples include;**

- ❖ Fungi and algae (lichen).
- ❖ Root nodules
- ❖ Leguminous plants and rhizobium bacteria.
- ❖ Protozoa and ruminants.
- ❖ Egret white bird and a cow.
- ❖ Bacteria and man in the small intestine.

## **5. Holozoic nutrition;**

This is the mode of nutrition where by food nutrients are taken into the body and broken down into smaller soluble molecules which can be absorbed and assimilated (utilized) by the body.

This mode of nutrition is normally found in mainly free living organisms which have a specialized digestive tract.

Holozoic nutrition is characterized by the following:

### **i) Ingestion:**

This is the taking in complex organic food into the body.

### **ii) Digestion:**

This is the breakdown of complex organic food into smaller diffusible molecules.

### **iii) Absorption:**

This is the taking up of soluble molecules from the digestive region across a membrane into the body tissues.

**iv) Assimilation:**

This refers to utilization of absorbed food molecules by the body to provide either energy or building up of body tissues.

**v) Egestion:**

This is the elimination of undigested food materials from the body.

Animals which undergo holozoic nutrition can be classified into three groups;

- ❖ Carnivores
- ❖ Omnivores
- ❖ Herbivores.

**Herbivores;** These live entirely on plant vegetation.

**Carnivores;** These feed on flesh e.g. lion, cat, dog.

**Omnivores;** These feed on both plants and animals e.g. man and a pig.

### **FOOD**

Food is any substance which can be digested and absorbed by the body to maintain the body's life processes (Metabolic process).

**Food is required by organisms for:**

- i. Growth so as to build new cells.
- ii. Respiration to produce energy
- iii. Repair of worn out cells or tissues
- iv. Protection of the body against diseases e.g. vitamins, proteins.

### **CLASSES OF FOOD**

There are three classes of food, namely:-

- a) Energy giving foods (fats and oils).
- b) Body building foods (growth foods) e.g. proteins.
- c) Protective foods, these protect the body against infections and diseases e.g. vitamins and minerals.

### **TYPES OF FOOD/NUTRIENT COMPOUNDS**

There are six different nutrient compounds namely:-

- |                  |                           |
|------------------|---------------------------|
| 1. Carbohydrates | 4. Mineral salts          |
| 2. Proteins      | 5. Roughages and water    |
| 3. Vitamins      | 6. Fats and oils (lipids) |

### **CARBOHYDRATES**

These are made up of carbon, hydrogen and oxygen.

They are either sugars or starches.

Carbohydrates are grouped into 3 categories which include monosaccharides, disaccharides and polysaccharides depending on number of sugar molecules they are composed of.

### **i) Monosaccharides**

Monosaccharides (mono=one, saccharide= sugar) are substances consisting of one molecule of sugar. They are also known as simple sugars.

#### **Properties of monosaccharides**

- They have a sweet taste
- They dissolve in water
- They form crystals
- Can pass through a selectively permeable membrane.
- They change the colour of benedict's solution from blue to orange when boiled with the solution thus they are known as *reducing sugars*.

***Monosaccharides include the following:***

1. Glucose (present in grapes)
2. Fructose (present in many edible fruits)
3. Galactose (present in milk)

### **ii) Disaccharides**

Disaccharides (di=two, saccharide= sugars) are carbohydrates molecules made up two simple sugars joined together. When the two monosaccharides combine, it results in the loss of one molecule of water and this reaction is called a condensation reaction.

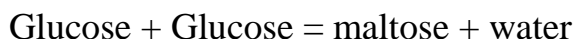

**The disaccharides have the following properties:**

- i) They are sweeter than monosaccharides
- ii) They can be crystallized
- iii) They are soluble in water
- iv) Do not change the colour of Benedict's solution when heated with it (apart from maltose)- they are known as non-reducing sugars
- v) Can be broken down into simple sugars by dilute mineral acids and enzymes

**Examples of disaccharides include:**

- 1) Sucrose (present in sugar cane)

- 2) Maltose (present in germinating seeds)
- 3) Lactose (present in milk)

### iii) Polysaccharides

Polysaccharides (poly = many, saccharide = sugar) are complex carbohydrates made up of many units of simple sugars.

#### Properties of polysaccharides include:

- ✓ Are not sweet
- ✓ Do not dissolve in water
- ✓ Cannot be crystallized
- ✓ Do not change the colour of Benedict's solution

#### Examples include:

- 1) Starch
- 2) Glycogen
- 3) Cellulose.

#### Functions of carbohydrates

- i) They provide energy in the body when oxidized during respiration.
- ii) They are the cheap sources of energy for living things
- iii) They act as food reserves which are stored within organisms e.g. many plants store food as starch and animals as glycogen.
- iv) They are important components of body structures e.g. cellulose is a component cell walls, chitin forms exoskeleton of arthropods, and heparin is anticoagulant in mammalian blood.
- v) They are important for commercial values as they provide raw materials for manufacture of various products such as cellulose provides raw materials for manufacture of paper and textiles.

*Deficiency of carbohydrates results in a deficiency disease called marasmus.*

#### Symptoms of marasmus

- i) High appetite.
- ii) Dehydration of the body
- iii) Growth retardation
- iv) Wastage of muscles
- v) Misery and shrunken appearance

### FOOD TESTS ON CARBOHYDRATES

#### 1. Test for reducing sugars

The reagent used is Benedict's solution (blue) or Fehling's solution (blue). Boiling is required.

Procedure	Observation	Conclusion
To 1 cm <sup>3</sup> of food solution,	Colourless or turbid	Little or

add 1 cm <sup>3</sup> of Benedict's solution and boil.	solution turned to a blue solution, then to a green solution, to a yellow precipitate, to orange precipitate and to a brown precipitate on boiling.	Moderate or Much or Too much; reducing sugars present.
	Colourless or turbid solution turned to a blue solution which persists on boiling.	Reducing sugars absent.

If Fehling's solution is used, the change is from blue solution to orange precipitate if reducing sugars are present. It remains a blue solution if they are absent.

### Examples of reducing sugars include:

- 1) Glucose (present in grapes)
- 2) Fructose (present in many edible fruits)
- 3) Galactose (present in milk)
- 4) Maltose (present in germinating seeds)

The conclusions based on colour changes are according to the following observations:

Blue **solution**- no sugars

Green **solution**- little sugars present

Yellow **precipitate**- moderate sugars present

## 2. Test for non-reducing sugars

procedure	Observation	conclusion
To 1 cm <sup>3</sup> of food solution add 1 cm <sup>3</sup> of dilute hydrochloric acid and	Colourless or turbid solution turned to a blue solution, then to a green	Little or Moderate or Much or

boil, cool under water then add 1 cm <sup>3</sup> of sodium hydroxide solution, followed by 1 cm <sup>3</sup> of Benedict's solution and boil.	solution, to a yellow precipitate and to a brown precipitate on boiling.	Too much; non-reducing sugars present.
	Colourless or turbid solution turned to a blue solution which persists on boiling.	Non-reducing sugars absent.

**Note:**

- i) When boiled with dilute HCl, the non-reducing sugars breaks down into the reducing sugars.
- ii) Sodium hydroxide solution or sodium hydrogen carbonate powder is added to neutralize the acid so that Benedict's solution can work.

**Examples of non-reducing sugars include:**

- i. Sucrose (present in sugar cane)
- ii. Lactose (present in milk)

**3. Test for starch:**

The reagent used is iodine which is a brown or yellow solution).

Procedure	Observation	Conclusion
To 1 cm <sup>3</sup> of food solution, add 3 drops of iodine solution.	Colourless or turbid solution turned to a black or blue-black or blue solution or brown solution with black specks.	Much or moderate or little starch present.
	Colourless or turbid solution turned to a yellow or brown solution.	Starch absent.

**PROTEINS**

These are food nutrients containing carbon, hydrogen, oxygen and nitrogen and sometimes sulphur or phosphorus. The smallest and building unit of proteins are called Amino acids. The amino acid molecule can condense to form dipeptide; further condensation gives rise to polypeptide molecule (protein).

The **amino acids** can be differentiated into essential and non-essential amino acids. There are a total of twenty (20) amino acids present thus allowing the formation of a variety of proteins.

### **Types of amino acids:**

#### **i) Essential amino acids**

These are amino acids which cannot be synthesized in the body. This means they can only be got from the diet.

#### **ii) Non-essential amino acids**

These are amino acids that can be synthesized by the body so they are not essential in the diet.

### **Sources of proteins:**

Food substances rich in proteins are eggs, lean meat, beans, Soya, milk and its products, fish and groundnuts.

### **Properties of proteins**

- i) Most dissolve in water to form colloidal or sticky suspensions.
- ii) They are denatured by high temperatures-their structure is completely changed.
- iii) They have both acidic and alkaline properties

### **The main functions of proteins**

- i) Body building which brings about growth i.e. from structures like in cell membrane, certain as in horns, fingernails, hooves etc.
- ii) Repair and regenerate tissues that are damaged or worn out.
- iii) Synthesis of body chemicals like enzymes, hormones, hemoglobin etc.
- iv) Provision of energy in times of starvation.

**Note:** Protein deficiency results in poor health especially in children where it causes *kwashiorkor*.

### **Symptoms of kwashiorkor**

- i) Loss of appetite
- ii) Diarrhea
- iii) The hair becomes soft and can easily be plucked out accompanied by loss of its colour.
- iv) Growth retardation
- v) Pot belly i.e. swollen lower abdomen
- vi) Swollen legs and joints i.e. Oedema.
- vii) Wasted muscles

## TEST FOR PROTEINS

There are two food tests for proteins: the *biuret* test and *Millon's* test. Due to toxic nature of Millon's reagent, it not commonly used any more.

The biuret test is more commonly used.

### The Biuret test:

Procedure	Observation	Conclusion
To 1 cm <sup>3</sup> of food solution, add 1 cm <sup>3</sup> of sodium hydroxide solution, then add 3 drops of Copper II sulphate solution and shake.	Turbid solution turned to a colourless solution then to a violet or purple solution.	Proteins present.
	Turbid or colourless solution turned to a blue solution.	Proteins absent.

### Millon's test:

Procedure	Observation	Conclusion
To 1 cm <sup>3</sup> of food solution, add 3 drops of Millon's reagent and boil.	A pink coagulated mass is formed.	Proteins present
	Turbid or colourless solution remained turbid or colourless.	Proteins absent.

## LIPIDS (FATS AND OILS)

Lipids also contain carbon, hydrogen and oxygen but with higher proportions of hydrogen and less oxygen than carbohydrates. Because of this, they are able to yield more energy than carbohydrates or proteins weight for weight when oxidized. Fats differ from oils in that they are solids at room temperature whereas oils are liquids at room temperature (25°C).

Fats are mainly found in animal tissues while oils are obtained from plant tissues.

Examples of fats include; kimbo, cow boy, tamu, margarine, etc.

Examples of oils include; fortune buto, sun seed cooking oil, ufuta cooking oil, etc.

Lipids are made up **fatty acids and glycerol**.

### Food sources:

Ground nuts

Eggs

Sun flower

Palm oil  
Castor oil, etc.

### Properties of lipids

- i) Fats and oils are distinguished from other nutrients in that they make a permanent translucent mark or spot on papers. This property also provides a simple test for fats and oils.
- ii) They also don't dissolve in water

### Functions of lipids

- i) Energy production during respiration
- ii) Insulate the body to prevent excessive heat loss; this has been of major adaptations in some small animals and those animals living in cold regions where the sub-cutaneous fats are largely deposited under the dermis of the skin.
- iii) Prevent water loss and entry in cells and tissues
- iv) They are also constituents of waxy cuticle of animals and plants and the cell membrane.
- v) In some areas of animals they act as shock absorbers
- vi) They can be used as a source of water in desert animals such as camels- when stored fat is broken down in the body, much water is produced.

### TESTS FOR LIPIDS

They are tested for using the emulsion test or the grease spot (translucent spot) test.

#### a) The emulsion test:

The reagents used are ethanol and water.

Procedure	Observation	Deduction
To 1 cm <sup>3</sup> of food solution, add 1 cm <sup>3</sup> of ethanol and shake. Then add 5 drops of water and shake.	A turbid solution turns to a cream emulsion	Lipids present.
	Turbid or colourless solution remains a turbid or colourless solution.	Lipids absent.

#### b) Translucent spot test:

Procedure	Observation	Conclusion
Add 2 drops of test solution on a piece of filter paper.	A translucent spot or patch is left on the paper.	Lipids present

Allow to dry and observe under light.	No translucent spot is formed on the paper.	Lipids absent.
---------------------------------------	---	----------------

## VITAMINS

These are organic compounds required in small amounts in the diet for the normal functioning of the body. They are designated with alphabetical letters and are classified into two:

- i) Water soluble vitamins
- ii) Fat soluble vitamins

Water soluble vitamins are those which dissolve in water. They include vitamins B and C.

Fat soluble vitamins dissolve in fats but not in water. They include vitamins A, D, E, and K.

**A table showing vitamins and their deficiency diseases**

<b>Vitamin</b>	<b>Common food source</b>	<b>Functions</b>	<b>Symptom of deficiency</b>
A (Retinol)	Green vegetables, liver, butter, margarine, egg yolk and carrots	Growth in children, resistance to diseases of eye (night blindness) and respiratory tract. good night(Dim light) vision	Night blindness( poor dark adaptation), frequent cold, sore eyes and wealthy skin
B <sub>1</sub> (Thiamine)	Yeast, beans, lean meat, egg yolk, bread and rice husks	Tissue respiration, keeps the heart, nerves and digestive organs healthy	Tiredness( fatigue), retarded growth in children and poor appetite, constipation( <b>beriberi</b> )
B <sub>2</sub> (Riboflavin)	Yeast, milk ,liver, cheese, leafy vegetables.	Tissue respiration, growth and health of skin. Keeps mucus membrane healthy	Retarded growth especially in children, cracks on lips, poor vision and skin disorders
B <sub>3</sub> (Nicotinic	Cereal grains,	Same as B <sub>2</sub>	Disorders of central

acid /Niacin)	milk and its products, liver and yeast		nervous system(CNS) like memory loss & depression( pellagra)
B <sub>12</sub> (cobamine)	Beef, kidney, liver, yeast	Forms red blood cells	Low blood count(Anemia)
C (Ascorbic acid)	Fresh fruits and row vegetables	Development of teeth and bones, normal growth and sticks together the cells lining parts of the body	Scurvy- Sore gums, poor healing of sores in the gum
D(calciferol)	liver, fish, egg yolk, formed beneath skin of man in sunlight	Building strong and hard bones and teeth, promotes absorption of phosphorus and calcium in the gut	Weak bones and teeth, rickets in children and dental caries
E(tocopherol)	All foods	Anti-oxidant to prevent excess energy production. Promotes fertility in animals e.g. rats	Sterility( infertility) in some animals like rats
K(phyllaquin one)	Cabbage, spinach	Normal clotting of blood	Prolonged bleeding.

### TEST FOR VITAMIN C:

The reagent used is DCPIP (Dichloro Phenol Indole Phenol). It is a deep blue solution. The sources of vitamin C are fresh fruits e.g. oranges, mangoes, lemon, etc.

Procedure	Observation	Conclusion
To 1 cm <sup>3</sup> of DCPIP solution in the test tube, add the food solution drop wise.	The blue DCPIP solution is decolourised or turned to a colourless solution.	Vitamin C present
	The blue DCPIP solution remained blue.	Vitamin C absent

## MINERAL ELEMENTS AND SALTS

These are inorganic food constituents required in small amounts but whose deficiency affects the normal functioning of the body leading to deficiency diseases.

**Mineral salts can be divided into;**

**(i) Essential mineral elements (macro elements)**

These are mineral elements required in relatively large amounts. They are sodium, potassium, phosphorous, calcium iron.

**(ii) Non-essential or Trace mineral elements (micro- elements)**

These are mineral elements required in relatively very small amounts. However, their presence in the diet is of at most importance. They are Zinc, Molybdenum, cobalt Manganese.

**A table showing some elements and their deficiency diseases**

<b>MINERAL ELEMENTS</b>	<b>SOURCE</b>	<b>IMPORTANCE</b>	<b>DEFFICIENCY</b>
<b>Fe</b> Iron	- Beef, liver, kidney, G.nuts, beans, eggs, green vegetables.	- It is a constituent of Haemoglobin.	<b>Anaemia</b> - Reduced red blood cell account. - Reduction in oxygen transportation rate.
<b>Ca</b> Calcium	Vegetables, fish, milk, bread, eggs.	- In blood clotting - hardening of bones and teeth.	<b>Rickets in children</b> - Delay in blood clotting - Soft bone, poor skeletal growth.
<b>P</b> Phosphorus	- Most foods	- Constituent of cell membrane. - Formation of teeth & bones.	- It is not likely for one to be deficient of phosphorus since it is found in most foods.
<b>I</b> Iodine	- Iodised salts - Marine fish	- It is a constituent of a haemone <b>Thyroxin</b>	<b>Goitre</b> - Swelling of the Thyroid gland. - Muscle cramp (sharp pains in muscles).
	Drinking water	It is constituent of	Weak teeth in children.

<b>F</b> Fluorine	(National water and sewage co-operation)	bones and teeth.	
<b>K</b> Potassium	Fish, beef, liver, mushroom and some tubers	Transmission of nerve impulse along neurons	Muscular cramp
<b>Na</b> sodium	Common salt(NaCl) and cheese	Transmission of nerve impulse along neurons	

## **WATER AND ROUGHAGES/DIETARY FIBRES**

### **WATER**

This compound is made of two elements namely Oxygen and Hydrogen. In living things, water forms about 60% of weight

#### **Importance of water**

- ✓ It's a universal solvent in which absorbed foods, wastes and hormones are transported around the body in blood.
- ✓ The plasma of blood is made up of water.
- ✓ It participates in many metabolic reactions or processes as a raw materials e.g respiration, photosynthesis, gaseous exchange, digestion, and removal of wastes.
- ✓ Plays a role in temperature regulation ie cooling the body on hot days and plants through transpiration.
- ✓ Offers turgidity thus acts as a hydrostatic skeleton- hence supporting organisms.
- ✓ It softens food.
- ✓ It is used in seed dispersal.
- ✓ It is a habitat (home).
- ✓ It acts as a Lubricant e.g. saliva lubricate the mouth, tears lubricate eyes, synovial fluids lubricate the joints.

### **ROUGHAGES / DIETARY FIBRE**

They are indigestible materials in food and consist mostly of cellulose, pectin, and lignin.

The major sources of roughages include: vegetables, such as cabbages, dodo, fruits, etc.

#### **Functions of roughages**

- ✓ They stimulate muscular movements called peristalsis which move food (propel) through the alimentary canal.
- ✓ Some delay food in the intestines whereas others enable food pass through the intestines very fast.
- ✓ The deficiency or lack of roughages causes constipation.

### **Balanced Diet:**

A balanced diet is a meal containing all food nutrients in their right proportions.

If a person depends on a poor diet (unbalanced diet) i.e. containing inappropriate quantities of nutrients, then the person suffers from Mal nutrition.

### **Mal-Nutrition:**

This simply refers to an unhealthy state of the body resulting from a long term deficiency or excess of one or more of the essential nutrients.

Malnutrition is normally detected by the onset of some deficiency diseases like kwashiorkor, marasmus, obesity, etc.

## **ENZYMES**

*Enzymes are organic compounds protein in nature that speed up the rate of biochemical reactions in the body of an organism and remains unchanged at the end of the reaction.*

### **Importance of enzymes**

The rate at which some reactions occur in the body without enzymes is too slow to sustain life. Enzymes therefore *speed up the rate of the reaction without changing the product formed and the nature of reaction* i.e. an enzyme cannot make a reaction that would not occur to take place and it cannot make an endothermic reaction exothermic but only ensures that products are formed in the shortest time possible.

*They also control metabolic processes hence promoting normal body functions.*

### **Classification of enzymes**

Enzymes are classified depending on the type of reaction they catalyze. The following are some of the classes of enzymes.

- 1) **Isomerase**; these catalyze reactions involving isomerism
- 2) **Phosphorylases**; these catalyze reactions involving addition of a phosphate
- 3) **Hydrogenases**; these catalyze reactions involving addition of hydrogen.
- 4) **Dehydrogenase**; these catalyze reactions involving removal of hydrogen.
- 5) **Kinases**; these catalyze reactions involving movement of molecules from one area to another.

**6) Carboxylases;** these catalyze reactions involving addition of Carbon dioxide.

Enzyme can also be described as being intracellular or extracellular. Intracellular enzymes are those which catalyze reactions inside the cells producing them, e.g. all respiratory enzyme are intracellular. Extracellular enzymes are those produced by a cell to catalyze reactions outside that cell. All digestive enzymes in man are extracellular.

### **Nomenclature of enzymes**

Enzymes are named by adding a suffix “ase” to their substrates. A substrate is a substance, which the enzyme acts upon, or simply it is the raw material for the enzyme.

### **Examples of enzymes and their substrates**

<b>Enzyme</b>	<b>Substrate</b>
Peptidase	Peptides
Lipase	Lipids
Maltase	Maltose
Sucrase	Sucrose
Lactase	Lactose
Cellulase	Cellulose

Some enzymes however retained their names they had before this convention. Such enzymes include pepsin and trypsin.

Sometimes the enzymes digesting carbohydrates are generally called carbohydrases and those digesting proteins as proteases.

### **PROPERTIES OF ENZYMES**

- 1) They are all protein in nature.
- 2) They are specific in their action i.e. they catalyze specific food i.e. Maltase on Maltose.
- 3) They speed up the rate of chemical reactions (they are catalysts).
- 4) They are effective even in small amounts.
- 5) They remain unchanged at the end of the reaction.
- 6) They are denatured by high temperatures since they are protein in nature and are inactivated by low temperatures.
- 7) They are inactivated by inhibitor chemicals (poisons e.g. cyanide).
- 8) They work at a specific PH. (either acidic or alkaline).
- 9) Their reactions are reversible.

- 10) Their activity can be enhanced by enzyme activators e.g. chloride ions activate amylase.

### FACTORS AFFECTING ENZYME ACTIVITIES

To investigate the effects of a given factor on the rate of enzyme controlled reactions, all other factors should be kept constant and at optimum levels so as to obtain accurate results.

The factors are:

- i) Temperature
- ii) Concentration of the substrate
- iii) PH of the medium
- iv) Presence of activators
- v) Presence of inhibitors
- vi) Concentration of the enzyme

#### 1. Concentration of substrate:

A substrate is a substance (food) acted upon by the enzyme to form simpler products.

The rate of enzyme reaction increases with increase in substrate concentration and enzymes work slower when the substrate concentrations low.

However, further increase in substrate concentration will not increase enzyme reaction rate since all its active sites are fully saturated with food.

#### A graph showing how the rate of reaction varies with substrate concentration

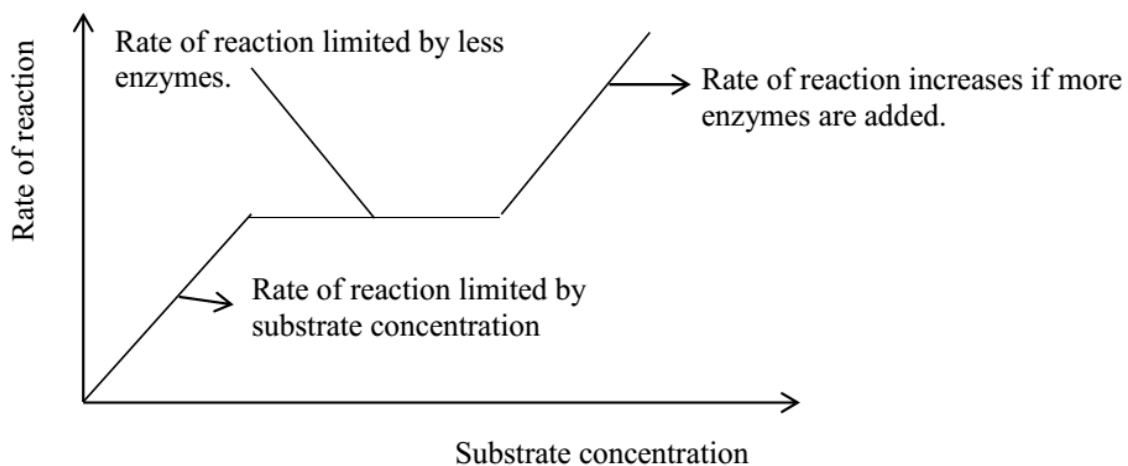

#### 2. Temperature:

Enzymes work best at optional temperatures of (approximately  $37^{\circ}$  C). At very low temperatures, the rate of enzyme reaction is very slow because the enzyme is inactive at such low temperatures.

As the temperatures increase, the rate of reaction also increases gradually until it attains a peak where it has maximum activity and this always correspond at optimal temperatures. An optimal temperature is which promotes maximum enzyme activity. However with further increase in temperature, the rate of reaction decreases exponentially, sharply, steeply since at high temperatures, the enzyme is denatured ie the active site of the enzyme which is (protein in nature) is a altered (changed) or completely destroyed.

### A graph showing the variation of enzyme activity with temperature

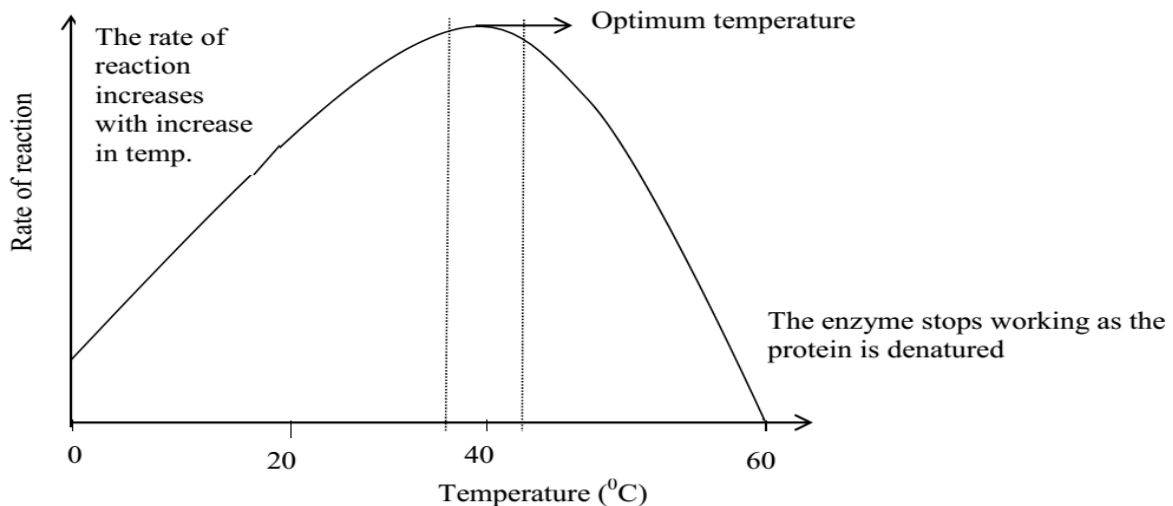

### 3. Enzyme concentration:

As the concentration of the enzymes increases, the rate of reaction also increases until all the substrates are being acted upon when the rate finally becomes constant.

A graph showing variation of enzyme activity with enzyme concentration

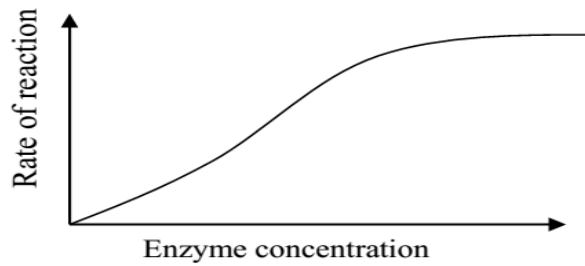

#### 4. The PH of the medium.

Enzyme reactivity is reduced or stopped completely if placed in a medium whose PH is different from that in which it works best (optimum PH).

PH varies slightly above or below an enzyme's optimum PH resulting in a marked fall in the enzyme efficiency. E.g. pepsin enzyme in the human stomach has a maximum activity with in acidic pH of 1.5 and 2.5 while the enzymes in the duodenum e.g. trypsin work at maximum with in alkaline pH of 8.5 to 9.5.

#### A graph showing variation of different enzyme activity with PH

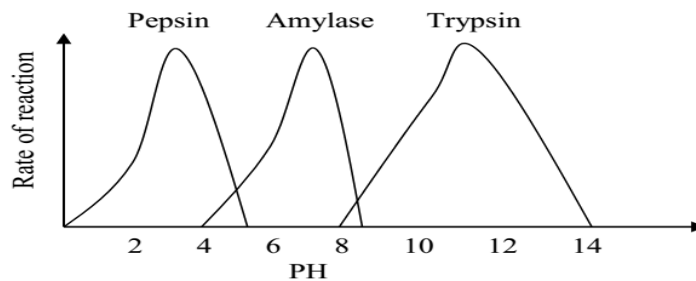

#### 5. Presence of enzyme inhibitors

Enzyme activities decrease in presence of enzyme inhibitors and increase in their absence.

#### 6. Presence of activators

Enzyme activators increase with presence of enzyme activators and decrease with absence of enzyme activators.

### Mechanism of enzyme action

The widely accepted mechanism by which enzymes are known to work is the “**key and lock**” hypothesis.

The hypothesis suggests that the enzyme has a specific region known as the active site where the substrate fits like a key fits in a lock. The substrate must have a complementally shape to the active site of the enzyme. In this hypothesis the key is analogous to the substrate and the lock to the enz

combines with the enzyme, an enzyme- substrate complex is formed. This breaks down to release the products and the enzyme, which can pick other substrates.

**A graph showing variation of different enzyme activity with PH.**

### Illustration

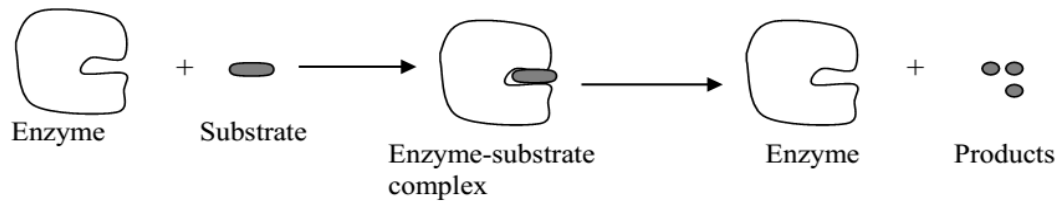

## MAMMALIAN TEETH

Mammals have different types and shapes of teeth and they are thus termed **Heterodonts**. Those which have teeth of the same size and shapes are termed as **Homodonts**.

Teeth are embedded in the upper and lower jaws. In mammals teeth consist of an exposed portion known as a **crown** and a portion that is firmly fixed or anchored in a jaw bone called a **root**.

### Types of teeth in mammals

There are 4 types of teeth in mammals and these include;

#### 1) Incisors

These are the front teeth in both the upper and lower jaws in man. The crowns are chisel shaped (sharp flat edge) and have only one root. ***Incisors are used for cutting food***

#### Structure of an Incisor

#### 2) Canines

These are found next to the incisors and they are normally long and pointed. They are poorly developed in herbivores and very prominent in carnivores where they are used for holding and piercing food. They have a conical shaped crown which is sharp and pointed. They have one root. ***They are used for tearing flesh.***

#### Structure of canine

#### 3) Premolars

These lie behind the canines on both jaws.

These have flat broad surfaces which are used for grinding food.

Premolars possess two or more **cusps** and **ridges** and have two roots.

*Premolars are used for grinding and chewing food.*

#### **Structure of premolar**

#### **4) Molars**

They are absent in young mammals.

These have wider crowns with more ridges and cusps compared to premolars.

They may have three or more roots.

*Molars are used for grinding and crushing food.*

#### **Structure of a molar**

#### **Note:**

- ❖ Elephant tusks are **incisors**.
- ❖ Carnivores have a special type of teeth called the **carnassial** teeth which are adopted for cracking bones and scrapping (removing) of meat from bones.

#### **Internal structure of mammalian tooth**

Each tooth consists externally of a crown, Neck and root.

##### **1) Crown**

This is a region of the tooth which projects above the gum; it is used for breaking down food.

##### **2) Neck**

This is the junction between the crown and the root.

##### **3) Root**

This is the region which lies embedded in the jaw bone. It cannot be seen and it anchors / fixes firmly the root into the jaw bone.

## Tooth structure

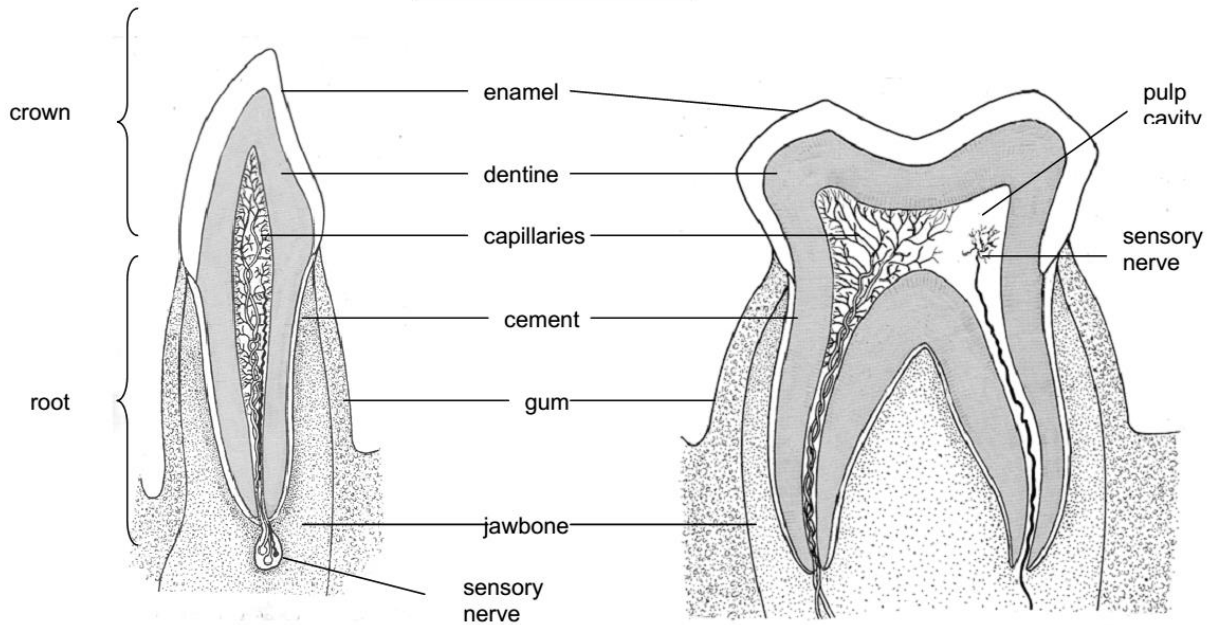

Vertical section through incisor

Vertical section through molar

### **Functions of the parts of the tooth**

- 1) **Crown**; this break down food into small particles during chewing, grinding and cutting.
- 2) **Enamel**; this strengthens the tooth to enable it grind and cut. It protects the dentine and pulp cavity. It is the hardest material in the body. It is white in colour and made up of *calcium phosphate salts*.
- 3) **Root**; this fixes the tooth into the jaw.
- 4) **Dentine**; this strengthens the tooth.
- 5) **Pulp cavity**; this contains nerves that provide sensitivity to the tooth and blood vessels that transport food and oxygen to the tooth.
- 6) **Gum**; this is fibrous which fixes or anchors the teeth firmly in the jaw. It is also called the gingiva.
- 7) **Cement**; this is a thin layer of bone-like material that fixes the tooth in the jawbone.

### **DENTITION**

This refers to the number, arrangement and shape of teeth in an animal.

In mammals, two sets of teeth occur in one's life time i.e. the milk teeth and permanent teeth. The first set is called the *milk teeth* which arises when the animal is young and lasts for relatively a short time. Milk teeth in man are 20 in number and normally get replaced by *permanent teeth* at the age of usually 7 to 11 years.

### **DENTAL FORMULA**

This is a formula indicating the number of each type of teeth in half the upper jaw and half the lower jaw. The dental formula gives evidence that the dentition of an animal is closely related to its diet. The number of teeth in the upper jaw is written above that of the lower jaw. The different types of teeth are represented by letters i.e.

- Incisors (i)
- Canines (c)
- Molars (m)
- Premolars (pm)

### Dental formulae of some animals

Mammal	Dental formulae	Total number of teeth
Man	$\begin{array}{cccc} I2 & C1 & PM2 & M3 \\ 2 & 1 & 2 & 3 \end{array}$	32
Dog	$I \frac{3}{3}; C \frac{1}{1}; p m \frac{4}{4}, M \frac{2}{3}$	42
Rat	$\begin{array}{cccc} I1 & C0 & PM0 & M3 \\ 1 & 0 & 0 & 3 \end{array}$	16
Cow	$\begin{array}{cccc} I0 & C0 & PM3 & M3 \\ 3 & 1 & 3 & 3 \end{array}$	32

E.g. the dental formula of an adult human is written as below:

$$I \frac{2}{2}; C \frac{1}{1}; p m \frac{2}{2}, M \frac{3}{3} = 32$$

This means that man has 2 incisors on each half on the top and lower jaws, one canine on each half of the top and lower jaws, 2 premolars on each half of the top and lower jaws. Therefore man has 8 teeth on each half on the jaws which adds up a total of 32 teeth.

### Dental care in man

Although hard teeth are delicate and need proper care if their life is to be sustained. Common problems that may arise if teeth are not cared for include:-

#### **i) Tooth decay or dental caries.**

This is caused by lodging (when food gets stuck) of food particles especially sugars between the teeth. This food is then attacked by micro-organisms (bacteria) which ferment this food producing an acid which reacts chemically with the

enamel and removes calcium from it making it soft. During chewing, the soft part of the enamel begins wearing away forming a hole which gets larger and larger as more food gets stuck in the now bigger hole and fermentation process continues. Tooth ache commences into the dentine, the pulp cavity with nerves and blood vessels get affected and a lot of pain is felt.

## **ii) Periodontal diseases.**

These are diseases which make the gum soft and flabby so that they do not support the tooth well. Sometimes these diseases may lead to bleeding of the gum and passing out of pus. The 2 periodontal diseases known are;

- ❖ Pyorrhea
- ❖ Gingivitis

They are characterized by reddening of the gums, bleeding and presences of pus in the gums.

### **Prevention of dental decay and proper care of teeth**

- ❖ Visit a dentist regularly for checkup.
- ❖ Proper cleaning of teeth (brushing after meals)
- ❖ Avoid sweet sugary foods like sweets which encourage bacterial growth.
- ❖ Avoid opening bottles using teeth carrying desks.
- ❖ Avoid eating very hot and very cold foods especially at a go since they result into alternate expansion and contraction since it leads to cracking or chipping of the enamel.
- ❖ Eating foods rich in calcium, phosphates and vitamins A, D, and C
- ❖ Exercising your teeth by eating hard fibrous foods like sugar canes, carrots, etc. This stimulates the flow of saliva which neutralizes acids formed bacterial fermentation.

### **CARNIVORE DENTITION**

Carnivorous animals such as dogs, cats and lions are adapted for feeding on other animals.

Their teeth are adapted for capturing and killing other animals and tearing their flesh.

Their incisors are chisel shaped and enable them to grip and strip off pieces of flesh from bones.

Their canines are long, curved and pointed used for piercing the prey and preventing it from escaping.

The upper fourth premolar and the first lower molar are large and powerful. They are called *carnassial teeth*. They overlap like blades of scissors and are used for tearing and slicing flesh.

The other premolars and molars have jagged edges that fit perfectly together making them ideal for cracking bones.

### Diagram showing dentition in the carnivore e.g. a dog

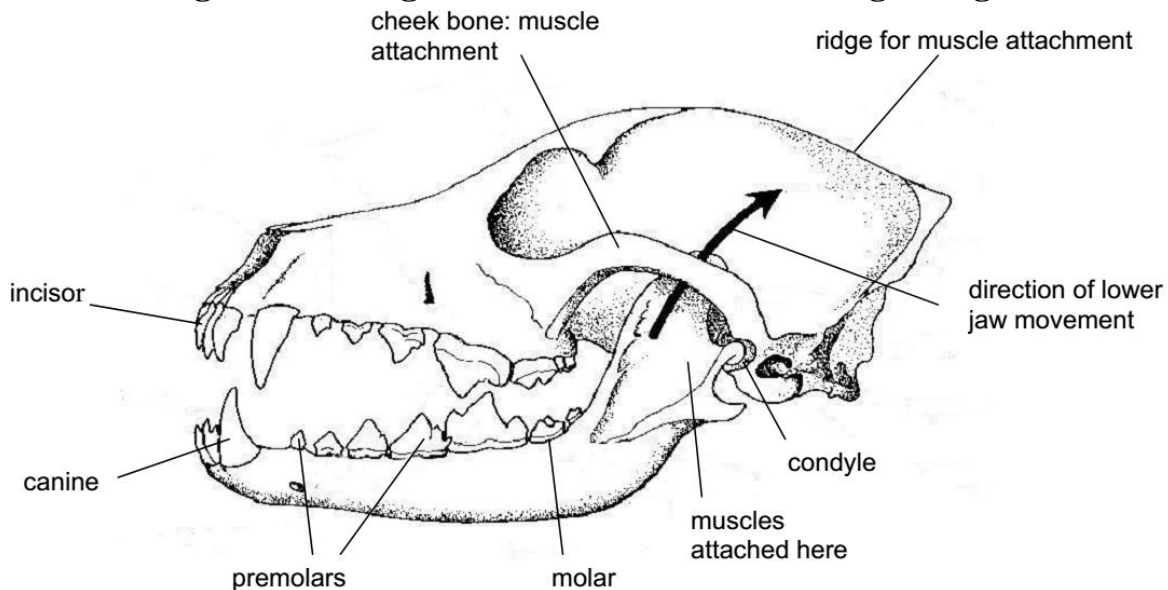

### HERBIVORE DENTITION

Herbivorous animals e.g. cows, goats and elephants eat plant foods such as grass, leaves and small stems.

Their teeth are adapted for crushing and grinding vegetables.

Their incisors and canines are chisel shaped and only found in the lower jaw.

In the upper jaw, the incisors and canines are replaced by a thick horny pad.

Grass and other vegetation are gripped between the incisors and canines on the lower jaw and the horny pad.

Between the front teeth and the cheek teeth is a large gap called *diastema*. It provides space for the tongue to manipulate vegetation in such a way that the material being chewed is kept away from that which is freshly gathered.

### Dentition of a sheep

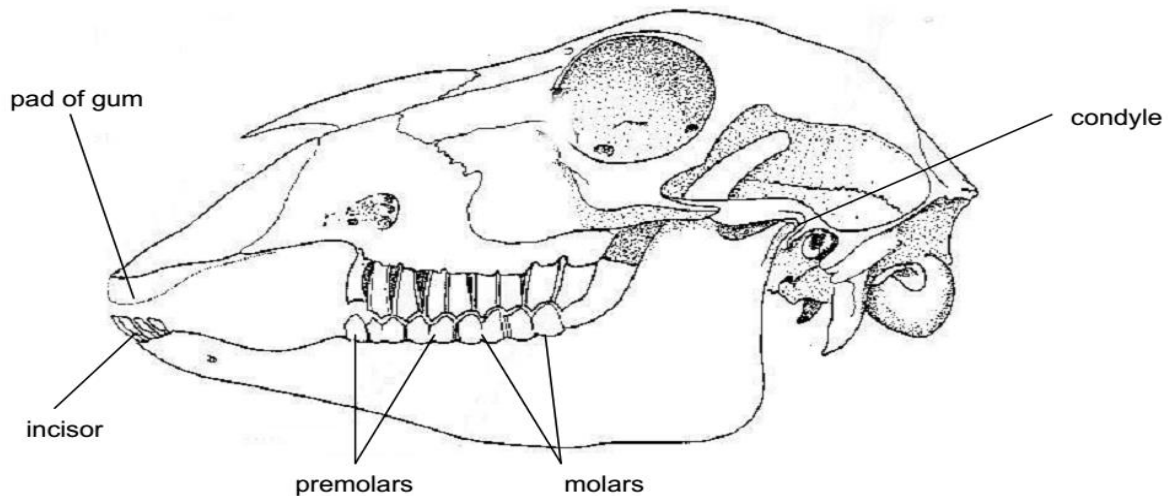

## DIGESTION IN MAN

*Digestion is the process by which complex food substances are broken down into simpler soluble compounds that can be absorbed and assimilated (utilized) by the body.*

Digestion can be divided into; physical or mechanical digestion and chemical digestion.

### **Physical digestion:**

This is the breakdown of food due to the mechanical action of teeth, muscular contractions and bile juice.

**Chemical digestion:** This is the breakdown of food due to enzyme action or enzymatic action.

### **Extracellular digestion:**

When digestion occurs or takes place outside the body or cells, it is called extracellular digestion. This may not necessarily be outside the body but it may occur inside the body but not inside cells. E.g. in fungi, man etc.

**Intracellular digestion:** This is a type of digestion which take place inside the body cells eg Amoeba, Paramecium.

Note: digestion in man is extracellular digestion because the enzymes are released in the gut cavity where digestion occurs.

### **Steps involved in digestion of food**

Ingestion → Digestion → Egestion

### **Ingestion**

Is the taking in of food into the body

### **Egestion**

This is the process by which insoluble undigested compounds of food are discharged or expelled from the body as faeces.

### The human alimentary canal

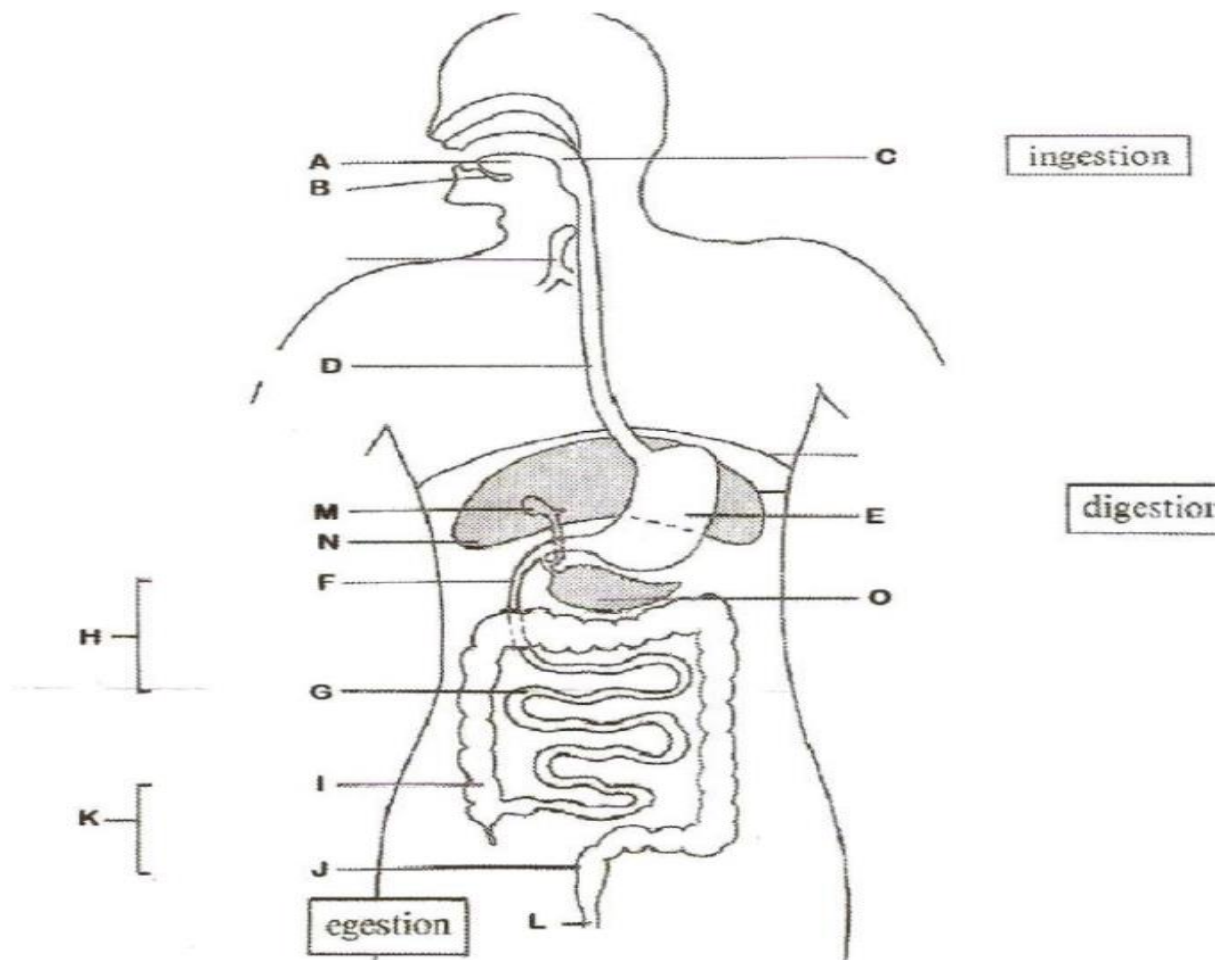

- |                       |                     |
|-----------------------|---------------------|
| A) Tongue.            | • Ascending colon.  |
| B) Salivary gland.    | • Transverse colon. |
| C) Buccal cavity      | • Descending colon. |
| D) Oesophagus/gullet. | J) Rectum.          |
| E) Stomach.           | K) Large intestine. |
| F) Duodenum.          | L) Anus.            |
| G) Ileum.             | M) Gall bladder.    |
| H) Small intestine.   | N) Liver.           |
| I) Colon;             | O) Pancreas.        |

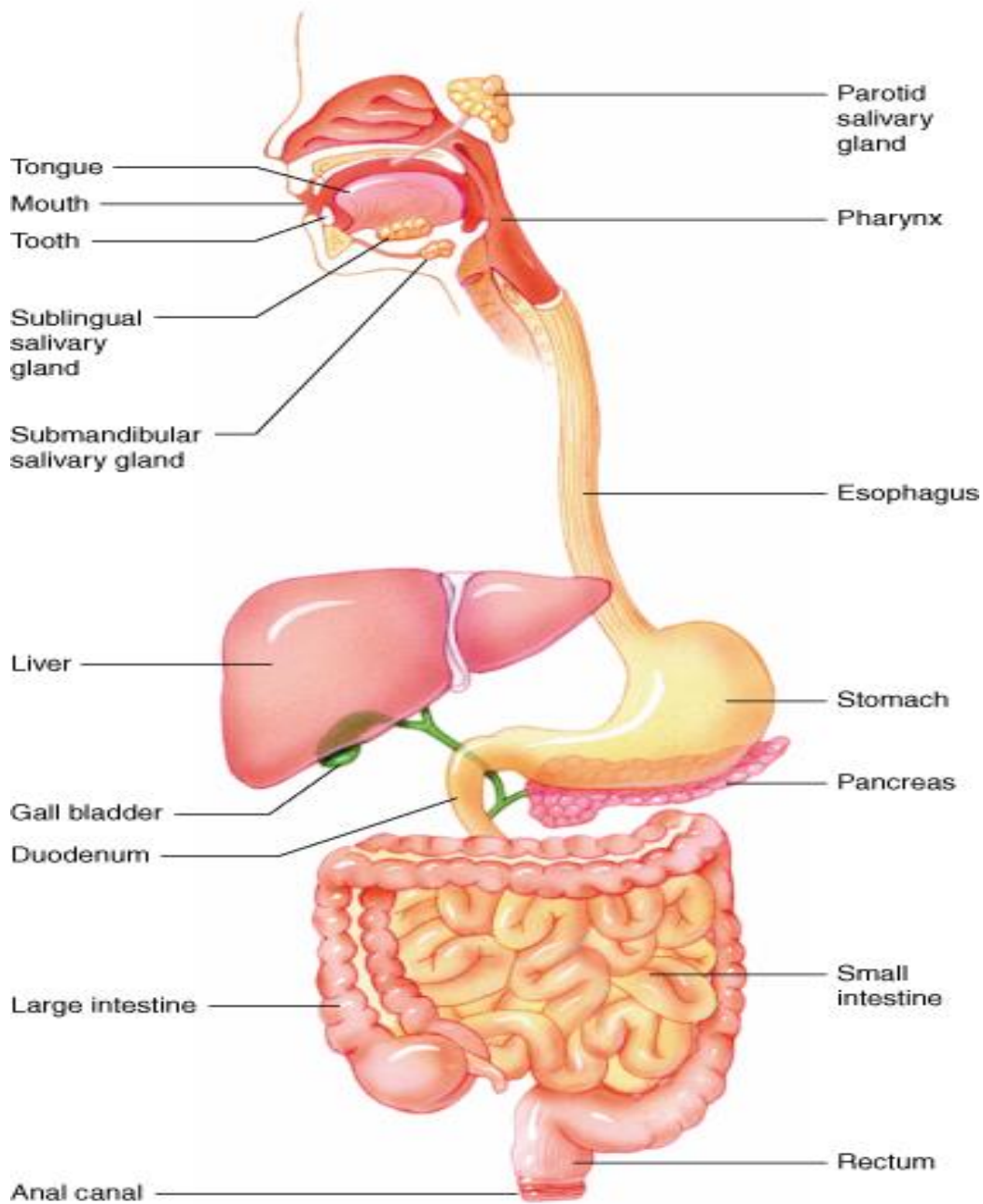

### Parts of the alimentary canal

#### iii. The mouth

The mouth has the teeth and salivary glands. The mouth opens to the large space called buccal cavity. The mouth is roofed by the plate of bone called hard plate which is continuous with the soft palate (pharynx).

Once food is in the buccal cavity, the teeth break down food particles into smaller particles providing a large surface area for the enzyme action. On the floor of the



cavity is the long muscular organ, the tongue which is covered by the taste buds. The tongue moves food around the mouth for chewing to occur and mixing with saliva secreted by salivary glands. Saliva contains enzymes and mucus which moistens, softens and lubricates food as well as sticking food particles together into boluses for easy swallowing. The enzyme in the saliva is called *salivary amylase (ptyalin)*.

iv. **Oesophagus**

This is a straight tube that passes from the mouth through the thorax and diaphragm into the abdomen.

When the food is fully chewed, the tongue rolls it into bolus pushes it against the soft palate at the back of the mouth (pharynx). This initiates the process of swallowing the food into the oesophagus. The tube adjacent to the oesophagus is the trachea which leads to the lungs. During swallowing, the flap of the tissue called epiglottis above the trachea prevents food from entering into the trachea.

v. **The stomach**

The gullet opens to the stomach which has a cardiac sphincter muscle at the entrance and pyloric sphincter muscle at the exit. (Sphincter is a circular band of muscle).

4) **The small intestine**

The small intestine is long and coiled with length of about 6-7metres in man. *It is made up of two parts; ileum and duodenum.*

5) **The duodenum**

This is the first part of the small intestine. It is short and wider than ileum. It bends into a loop to accommodate the pancreas.

The ducts passages open into duodenum are;

- ❖ The bile duct from the liver and gall bladder,
- ❖ The pancreatic duct from the pancreas.

**Functions of bile**

- i) It contains high % of water and adds it to the food coming from the stomach called chime.
- ii) It's alkaline and neutralizes the HCl of the chime to stop the action of the stomach enzymes and allow enzymes in the pancreatic juice to begin working.

iii) It reduces the surface tension of fats and breaks them into minute droplets i.e. emulsifies fat.

### **6) The ileum**

This is the second part of small intestines. It is long and coiled with length of about 6-7metres in man. It involves digestion and absorption.

Its lining has numerous tiny finger-like structures called villi (singular; villus) which increase surface area for absorption.

### **7) The large intestines**

In man it consists of colon, appendix and rectum which open at the anus.

Note: in rabbits, the large intestine consists of the caecum which is very large and ends in the blind appendix and small colon leading to the rectum.

## **DIGESTION IN THE MOUTH**

Digestion in the mouth is both physical and chemical.

### **a) Physical digestion**

Physical digestion in the mouth is carried out by the action of teeth or is the act of Mastication / chewing.

### **Mastication is important in that;**

- i) Increase the surface area of food for efficient Enzyme action.
- ii) It helps to mix the food with saliva and in so doing; it softens the food, mixes it with the enzymes and lubricates it with the mucus in the saliva.
- iii) With the help of the tongue , the food is rolled into a Bolus (a small ball) for easy swallowing and movement in the gut.(alimentary canal)
- iv) Chewing stimulates enzyme secretion because the secretion of saliva is a reflex action stimulated by the presence of food in the mouth.

**NOTE:** The secretion of saliva can also be stimulated by sight, smell and sought of food.

### **b) Chemical digestion in the mouth.**

Chemical digestion is carried out by the enzyme Salivary amylase

Saliva is an alkaline watery solution and it provides the optimal PH for the action of amylase i.e a high PH.

Salivary amylase acts only on cooked starch breaking it down to disaccharide called Maltose.

Cooked starch  $\xrightarrow{\text{Salivary amylase}}$  Maltose.  
(Ptyalin)

### **The act of swallowing:**

Swallowing is a reflex action. Here, food is rolled into a Bolus which is then transferred into the Oesophagus (gullet).

During the act of swallowing, breathing momentarily stops and the epiglottis closes the Entrance into the trachea preventing food from entering into the trachea.

At the same time, the soft palate also closes the entrance into the nose cavity preventing the food from escaping or passing through the nose.

Once the bolus is in the oesophagus, the food moves by a wave of muscular contractions called *Peristalsis*.

### **DIGESTION IN THE STOMACH**

Most of the digestion in the stomach is chemical. Food is allowed into the stomach from the oesophagus by a ring of muscle called the *Cardiac Sphincter*.

*In the stomach, there is only protein digestion.*

Gastric juice is secreted and it contains two enzymes, (pepsin and renin), hydrochloric acid, mucus and water.

*Pepsin acts upon proteins/ breaking them down into polypeptides.*

Pepsin is initially secreted in an inactive form called Pepsinogen which is activated into active pepsin by hydrochloric acid. This is the safe guard mechanism because if pepsin was stored in its active form, it would destroy the gut walls or stomach walls since they are protein in nature (self-digestion).

Pepsin works at low PH i.e. acidic conditions provided by the presence of Hydrochloric acid (HCl).

*Renin coagulates milk.* (Makes it insoluble) i.e. it converts the soluble milk protein caseinogen to an insoluble curd, casein which is then acted upon by pepsin breaking it down to polypeptide.

Rennin is an important enzyme especially in young mammals since they feed on milk.

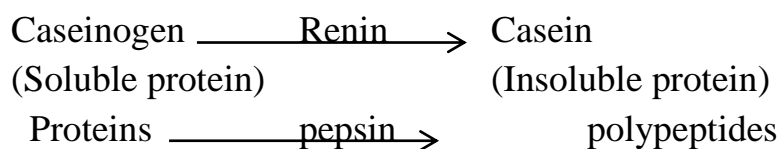

### **Functions of HCl in the stomach**

- i) It kills some bacteria in ingested food.
- ii) It activates pepsin and renin and provides ideal medium for their activity.
- iii) It stops the action of salivary amylase and ensures protein digestion only.
- iv) It prevents fermentation of food in the stomach by bacteria.

**Mucus:**

Mucus forms a barrier between stomach walls and Gastric juice thus protecting the stomach walls from the action of hydrochloric acid (which can give rise to stomach ulcers due to its corrosive action) and also stops the action of pepsin which can digest the stomach walls also giving rise to ulcers.

### DIGESTION IN THE DUODENUM

The chime from the stomach enters the duodenum in small quantities at a time regulated by the *pyloric sphincter*. There are access organs which provide secretions. They secrete bile from the gall bladder and pancreatic juice from the pancreas.

The arrival of food in the duodenum stimulates the production of a hormone called *secretin* from the pancreas and another hormone called *cholecystinin* which stimulates secretion of bile from the gall bladder. The secretions are alkaline thus stopping the action of pepsin and provides an ideal medium for enzymes in pancreatic juice to work. Pancreatic juice contains a number of enzymes which are called the *pancreatic enzymes*.

Enzymes	Food acted upon	Products
Trypsin	Proteins	Peptides and Amino acids
Pancreatic amylase	Starch	Maltose
Pancreatic lipase	Lipids	Fatty acids and glycerol

Trypsin is also secreted in an **inactive** form, **trypsinogen** to prevent it from digesting the duodenum walls.

*Both trypsin and pancreatic amylase act upon proteins and starch that were not broken down in the stomach and mouth respectively.*

### DIGESTION IN THE ILEUM

This is where final digestion takes place.

Food moves down from the duodenum into the ileum by peristalsis.

The presence of food in the ileum stimulates the secretion of the *intestinal juice, succus entericus by walls of the ileum*.

Succus entericus contains several enzymes which complete the process of digestion forming a milky fluid substance called *chyle* (food after final digestion is called **chyle**).

Enzymes	Food and Upon	Products
Sucrase	Sucrose	Glucose and fructose

Maltase	Maltose	Glucose and glucose
Lactase	Lactose	Glucose and galactose
Peptidase	Polypeptides	Amino acids
Lipase	Lipids	Fatty acids and glycerol

The composition of chyle is a group of soluble end products of digestion namely; Glucose, Fructose, Amino acids, Glycerol, Vitamins and Mineral salts.

### **DIGESTION IN THE LARGE INTESTINES / COLON**

In the colon, water and mineral salts are absorbed. The undigested and indigestible food substances pass down into the large intestines which are eventually removed from the body as faeces through the anus. *There is no digestion in the large intestine.*

Accumulation of hard particles like stones, small sticks in the appendix results into a condition known as **appendicitis**. The appendix is thus removed surgically by a simple operation.

#### **SAMPLE QUESTIONS:**

**Question 1:** Describe the digestion process that occurs when a person consumes Posho (starch)?

#### **Answer:**

A piece of Posho is placed into the mouth, a process called ingestion.

*In the mouth;* The Posho is thoroughly chewed by teeth, breaking it into smaller particles. During this chewing, Posho is mixed with saliva to make it soft and easy to swallow.

Saliva contains salivary amylase which breaks down cooked starch in Posho into maltose under neutral conditions.

Food is then pushed down the Oesophagus by a process called peristalsis.

*In the stomach;* no digestion of starch occurs because of acidic conditions due to presence of hydrochloric acid which provide unfavourable pH for activity of salivary amylase.

*In the duodenum;* the pancreatic juice contains pancreatic amylase which speeds up the breakdown of undigested cooked starch to maltose.

*In the ileum,* intestinal juice contains maltase which speed up the breakdown of maltose to glucose molecules which are soluble hence easily absorbed by the body. This marks the end of the digestion for Posho.

## **Question 2:**

Describe the process of digestion of proteins in man.

### **Answer:**

*In the mouth;* Protein food is chewed by the teeth and swallowed into the stomach.

*In the stomach;* gastric juice is produced which contain pepsin that digests proteins to peptides and rennin coagulates protein milk in babies.

*In the duodenum;* presence of food stimulates pancreas to secrete pancreatic juice containing trypsin which digests undigested proteins to peptides.

*In the ileum;* intestinal juice is produced containing peptidase which break down peptides to amino acids which are later absorbed through the ileum walls.

## **THE PROCESS OF ABSORPTION AND ASSIMILATION OF FOOD**

### **ABSORPTION**

*Absorption is the process by which soluble products of digestion diffuse through the cellular lining of the villi into the blood stream.*

The villi are located in the ileum (small intestine) and thus absorption takes place in the small intestine. Some nutrients like minerals and vitamins also enter the villi by active transport.

**The ileum shows various adaptations to suit the process of absorption which includes:**

- i) It is highly coiled/folded and consequently long thus providing a large surface area for digestion and absorption of food. (It is six (6) meters long).
- ii) Has a thin layer of cells to reduce the diffusion distance over which soluble food passes through.
- iii) They are highly supplied with blood capillaries and lacteals which transport away absorbed food thus maintaining a diffusion gradient.
- iv) Have finger-like projections called the villi which increase the surface area for absorption of soluble food.
- v) The villi also have hair like extensions called the micro villi which *further* increase the surface area for absorption of soluble food products. The villi are the actual sites for absorption of soluble food products.

## Diagram of Villus

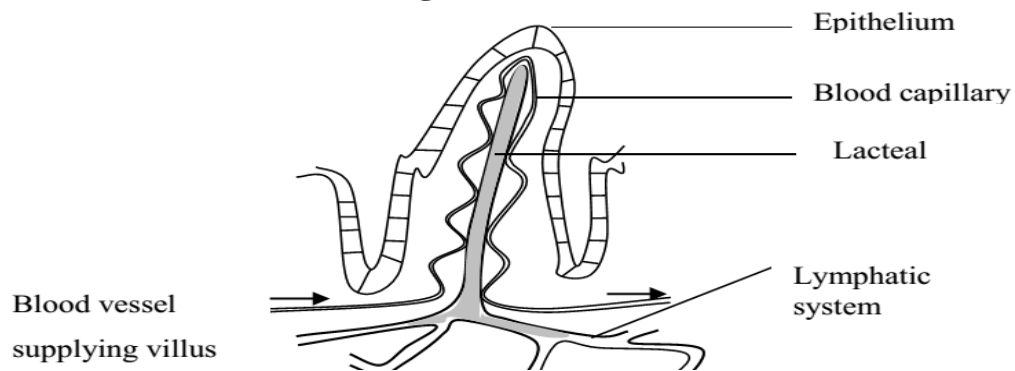

***Fatty acids and glycerol are absorbed into the lacteal of the villi.*** These lacteal later join up to form the lymphatic system carrying these food materials and distributing them to all parts of the body.

Glucose, Amino acids and Fructose pass into the blood capillaries of the villus which join up to form the Hepatic portal vein which transport these nutrients to the liver.

## ASSIMILATION

***This is the process by which absorbed food materials are built up into complex constituents of the organism.***

***Assimilation is also the incorporation/utilization of the products of digestion into the body's metabolism for life processes e.g. respiration, growth and repair and digestion.***

### **Assimilation and metabolism for:**

#### **1) Carbohydrates: (Glucose)**

Glucose is mainly broken down in the process of respiration to provide energy for the body's metabolic process.

Excess glucose is stored as **Glycogen** (animal starch); however, the liver has the ability to re-covert back the glycogen to Glucose in periods of starvation.

#### **2) Proteins**

Amino acids are used in the synthesis of new proteins especially regulators like enzymes, and hormones.

Some Amino acids are used in body growth and repair and in absence of Glucose and Fats, Amino acids can instead be used in the process of respiration to produce energy.

Excess Amino acids are not stored in the liver, they are instead **deaminated** by the liver (removal of the Amino group) to form urea which is then passed on to the kidneys and excreted in urine.

**Deamination** is the removal of the amino group from Amino acids to form urea (which is a toxic waste product).

### **3) Lipids (Fatty acids & Glycerol)**

Fatty acids and glycerol in the absence of Glucose can be oxidized to release energy. Fats produce much more energy compared to glucose considering the same amount by mass.

Fats are used for body insulation i.e. they prevent heat loss from the body which is an important temperature regulatory mechanism.

Lipids are used in the formation of structures like the cell membrane.

Excess fats and Glycerol are stored under the skin in the **adipose tissue**.

## **THE LIVER**

This is the largest organ in the body and it carries out several functions within the body. The liver is the body's metabolic center as it receives all nutrient supplies from the blood through the *hepatic portal vein*.

### **Functions of the Liver**

- i) Assimilation and metabolism of carbohydrates.
- ii) Assimilation and metabolism of proteins.
- iii) Assimilation and metabolism of lipids.
- iv) Production of heat helps in temperature regulation. Since there are many metabolic reactions occurring in the liver, there is a lot of heat given off-and this heat is distributed throughout the body and it plays a great role in temperature regulation.
- v) Manufacture of plasma proteins in clotting of blood. The liver helps to manufacture proteins like Albumin, Globulin and fibrinogen which are important in body process like clotting of blood (stopping bleeding).
- vi) Production of bile which emulsification lipids. The liver produces bile which is important in the process of digestion i.e. in the emulsification of lipids.
- vii) Storage of iron and other minerals. The liver destroys worn out blood cells and removes the iron group from them which it stores for future formation of other blood cells.
- viii) Formation of red blood cells with the iron yet from the above process, coupled with vitamin B<sub>12</sub>. New red blood cells can formed in the bone marrow using these raw materials.

- ix) Storage of blood. Blood vessels in the liver can expand and contract to great extents such that the amount of blood in the liver can vary from  $300\text{cm}^3$  –  $1500\text{cm}^3$  an increase of five times thus the liver can be a blood reservoir.
- x) Detoxification. The liver converts toxic substances to harmless substances by altering their chemical structure and later sends them to the excretory organs for expulsion e.g. it converts Ammonia to urea which is then expelled by the kidneys.
- xi) Elimination of sex hormones. Testosterone and oestrogen are sent to the kidneys by the liver for excretion.

## **DIGESTION IN HERBIVORES**

Animals that depend on plant materials (herbivores) like leaves, wood, grass are faced with a problem of digesting the cellulose that make up the plant walls.

It is necessary to break through the cellulose to release the inside cell nutrients which are required by the herbivores.

These herbivores cannot secrete the enzyme which digests cellulose because they cannot produce **cellulase**. However, some protozoans and bacteria can produce the enzyme cellulase.

Fortunately, some of these micro-organisms can live in the guts of herbivores in a harmless beneficial nutritional association called *symbiosis*.

### **Digestion of cellulose in ruminants**

Ruminants are mammals which chew cud.

Cud is imperfectly / incompletely chewed grass or plant materials that are taken into the stomach (rumen) and later returned back to the mouth for further chewing through a process called *regurgitation*.

Ruminants have a complicated stomach made up of four chambers namely;

- i) Rumen
- ii) Reticulum
- iii) Omasum
- iv) Abomasum

**Diagram showing the stomach of a ruminant and the flow of food through it**

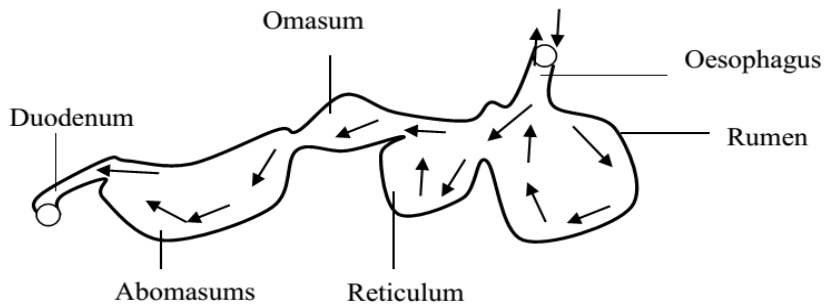

In the mouth, the saliva does not contain any enzyme. So only mastication (chewing) and softening of food takes place.

The food moves through the oesophagus by peristalsis (wave like motion).

### 1. Rumen:

This is the largest component (chamber) of the stomach. It is used for storing food as the animal feeds. Fermentation and digestion of cellulose by bacteria and protozoa occurs in the rumen.

Fermentation is the breakdown of food by bacteria in the absence of oxygen.

During fermentation, there is a release of a weak acid called ***lactic acid***.

Food then moves from the rumen to the reticulum and from the reticulum back to the rumen where regurgitation takes place (This is where food is returned to the mouth bit by bit for further chewing and that completes the first cycle).

### 2. Reticulum:

Bacterial action continues here and also food is sieved where finely ground food materials are separated from the coarse materials which are then retained. These coarse materials may include small stones, small pieces of wood, etc.

### 3. Omasum:

This consists of parallel leaf like compartment with rough surfaces.

Food is ground finely here and water absorption also takes place.

### 4. Abomasum (True stomach)

Here, enzymatic digestion of proteins takes place like in human and digestion beyond this point also proceeds like in humans and that is why we refer it as a true stomach, you can continue in the same line in humans e.g. colon.

## Digestion of cellulose in termites

Termites eat wood, dry leaves and other plant materials which contain cellulose. The digestion of cellulose also takes place in the gut (stomach) with the help of protozoans which lives symbiotically in the termite's gut.

These protozoa have the ability to produce the enzyme cellulase which digests cellulose.

## COMPARISION BETWEEN RUMINANT AND NON RUMINANT DIGESTION

### Similarities:

- i) In both, young animals have a single stomach where digestion takes place.
- ii) The final digestion of proteins and carbohydrates takes place in the small intestines.

### Differences:

Ruminant	Non-Ruminant
1. Chew cud.	Do not chew cud.
2. Have a four chambered stomach.	Have a single stomach.
3. Ptyalin (salivary amylase is absent in saliva.	Ptyalin is present in saliva.
4. Most digestion and absorption takes place in the stomach.	Most digestion and absorption takes place in the ileum.
5. Water absorption takes place in the stomach.	Water absorption takes place in the colon.

## NUTRITION IN PLANTS

Nutrition in plants is by a process called photosynthesis.

The process of photosynthesis is divided into two stages;

- i) Light stage
- ii) Dark stage

Photosynthesis is the process by which living plants manufacture their own food in form of carbohydrates (starch) from raw materials i.e. carbon dioxide and water using sunlight energy trapped by chlorophyll and give off oxygen as a bi-product.

In summary photosynthesis is a natural process that;

- (i) requires two raw materials (carbon dioxide and water)
- (ii) requires two conditions (i.e. chlorophyll and sunlight energy)
- (iii) and forms two products namely (starch or carbohydrates & oxygen)

The process of photosynthesis occurs in all green plants in organs called **chloroplast** most of which are found in leaves.

Chloroplast contains chlorophyll which traps sunlight energy.

The process of photosynthesis is very complicated but it can be summarized by the equations below.

Carbon dioxide + water  $\xrightarrow[\text{Chlorophyll}]{\text{Sunlight energy}}$  starch (Glucose) + oxygen

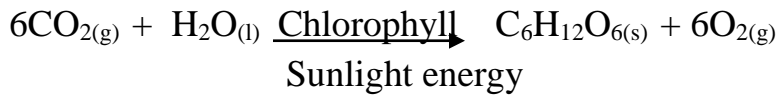

The insoluble starch (storage carbohydrates) is then converted to soluble glucose which is then transported by the phloem to different parts of the plant body especially storage organs like the roots (in cassava and sweet potatoes) stems (in sugarcane and Irish potato) or transported to actively metabolizing parts of the plants e.g. the growing regions, and the respiring parts.

On reaching these storage organs, the soluble glucose is then reconverted back to insoluble starch for storage.

## CONDITIONS NECESSARY FOR PHOTOSYNTHESIS TO TAKE PLACE

### 1) Chlorophyll:

Chlorophyll is a green pigment that absorbs light energy from the sun. The amount of chlorophyll present in a leaf is directly related to the rate of photosynthesis.

### 2) Carbon dioxide:

It is absorbed from the atmosphere by terrestrial plants through their stomata. For aquatic plants like algae, they absorb the carbon dioxide as hydrogen carbonates which diffuse directly from the water in plant tissues. The use of carbon dioxide is to combine or react with hydrogen atoms to form carbohydrates. Thus  $\text{CO}_2$  is used as a raw material.

### 3) Light:

This is the source of energy necessary for the process of photosynthesis to take place. The rate of photosynthesis increases in light intensity, up to a maximum when it levels off. The energy of light is used for the following purposes:

- i) Used to split water molecules into hydrogen atoms and oxygen. The oxygen is given off by the photosynthesizing plants. The hydrogen atoms combine with  $\text{CO}_2$  to form carbohydrates.

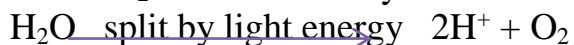

- ii) Provides energy for photosynthesis. The process by which light energy splits water into  $\text{H}^+$  and oxygen is called photolysis of water.

### 4) Temperature:

Temperature influences the rate of chemical reactions which are controlled by enzymes which are protein in nature.

The rate of photosynthesis doubles for every ten degrees centigrade (10<sup>0</sup>C) rise in temperature up to about 40<sup>0</sup>C where the rate of photosynthesis drops drastically because the enzymes are denatured

#### **5) Water:**

Water is a raw material for the process of photosynthesis. It is absorbed by the root hairs from the soil and transported up the root by the xylem vessels.

A decrease in the concentration of water lowers the rate of photosynthesis.

#### **6) Oxygen:**

Oxygen is not necessary for the process of photosynthesis i.e. it is a bi-product of thus its accumulation instead lowers the rate of photosynthesis.

### **Adaptation of leaves to carry out photosynthesis**

The leaf is the major organ of photosynthesis in a plant.

The leaf is adapted to carry out the photosynthesis process in a number of ways namely

#### **External adaptations**

##### **Leaves are broad and flat:**

This provides a large surface area for trapping sunlight and taking in of Carbon dioxide.

##### **Numerous leaves:**

This helps to increase the total surface area exposed to the sun thus increasing the rate of photosynthesis.

##### **Thinness:**

Most leaves are just a few cells thick thus providing a small diffusion distance for penetration of carbon dioxide and sunlight.

##### **Leaf arrangement / leaf mosaic:**

Leaves are usually arranged in such a way that they rarely shade or block each other thus ensuring that each leaf obtains maximum sunlight for photosynthesis. This is termed as a leaf mosaic.

#### **Internal adaptation of a leaf**

##### **Palisade mesophyll layer**

The layer **contains numerous chloroplasts** especially the palisade thus it is the best position to receive sunlight.

Their elongated shapes minimize the number of cross wall which would minimize light penetration by absorbing some of it.

##### **The spongy mesophyll layer**

This layer has mainly **air spaces** thus allowing many gases to easily diffuse into all the photosynthesizing cells.

### **Network of veins (vascular tissues)**

The vascular tissues include the xylem and phloem where by xylem transports water and mineral salts up to the stem while the phloem transports food (starch) up to the stem.

The network contains the phloem and the xylem where by the phloem conducts food made by the leaf and the xylem conducts dissolved mineral salts up to the stem.

### **Presence of stoma:**

This controls passage of gases and water vapour between air and the leaf.

There are more stomata on the lower side of the leaf compared to the upper side to reduce water loss by transpiration.

### **The cuticle**

This is a water tight layer and so it helps to prevent desiccation (water loss) by the photosynthesizing tissues.

### **Numerous chloroplasts**

These ensure that enough sunlight is trapped by the chlorophyll.

## **EXPERIMENTS ON PHOTOSYNTHESIS**

### **Experiment 1**

#### **AN EXPERIMENT TO TEST LEAF FOR STARCH**

The presence of starch is evidence that photosynthesis has been taking place.

#### **Apparatus:**

- A green leaf,
- water bath,
- Iodine solution,
- Water
- absolute alcohol (99%-OH),
- beaker,
- white surface or tile

#### **Procedure:**

- 1) A leaf from a health plant which has been receiving sunlight is removed and placed in boiling water (water bath) for about 5 minutes. This softens the leaf cell wall protoplasm and makes it permeable to Iodine.
- 2) The leaf is then placed in a beaker containing 99% alcohol and boiled using a water bath until all the chlorophyll is dissolved out. This decolorizes the leaf and makes detection of any colour changes possible and easier.
- 3) The leaf is then washed in hot water which softens it.
- 4) The leaf is now spread on a white surface tile and drops of iodine added on it.

#### **Observation:**

A blue black colour shows that starch is present.

NOTE: If the brown colour of iodine persists/ remains this shows that the leaf lacks starch or the starch is absent.

### Conclusion:

The presence of starch in a leaf shows that photosynthesis was taking place.

### Experiment 2:

#### AN EXPERIEMENT TO SHOW THAT OXYGEN IS GIVEN OFF DURING PHOTOSYNTHESIS

#### Apparatus:

- Afresh water weed.
- Funnel and wooden blocks.
- Test tube,
- beaker
- Water.
- Sodium hydrogen carbonate.

#### Procedure:

- a) The funnel is inverted in the beaker over the plant.
- b) Sodium hydrogen carbonate is added to the water to provide  $\text{CO}_2$
- c) The funnel is raised slightly above the bottom of the beaker using small wooden blocks to allow water to circulate freely under it.
- d) The apparatus is then placed in the bright sunlight.
- e) Another similar set up is made and placed in darkness. This acts as the control experiment.

The apparatus is arranged as shown below:

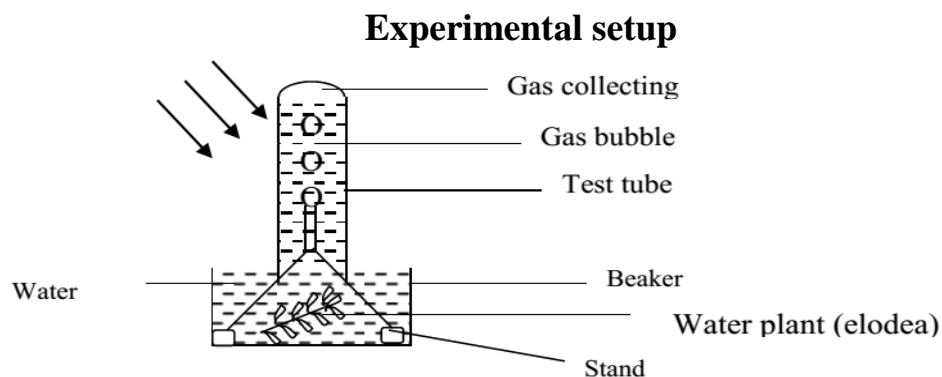

#### Observation:

Gas bubbles are evolved and sufficient gas is collected at the top of the test tube. In the control experiment, no bubbles are involved.

#### Conclusion:

The gas collected relights the glowing split proving that it is oxygen.

The evolution of oxygen by the water plant in the presence of sunlight is an indication that photosynthesis is taking place.

**NOTE:** This experiment can also be carried out to estimate the rate of photosynthesis (speed) by counting the number of bubbles produced per unit time.

### Experiment 3:

## AN EXPERIMENT TO SHOW THAT LIGHT IS NECESSARY FOR PHOTOSYNTHESIS

### Apparatus/materials:

- |                 |                  |                |
|-----------------|------------------|----------------|
| ❖ Potted plant  | ❖ White tile     | ❖ Boiling tube |
| ❖ Aluminum foil | ❖ Source of heat | ❖ Razor blade. |
| ❖ Water         | ❖ Wire gauze     |                |
| ❖ Ethanol       | ❖ Dropper        |                |

### Procedure:

- 1) Get a potted plant and place it in darkness for 24 hours to destarch it.
- 2) Make a shape in an aluminum foil and make a stencil
- 3) Place the stencil around the leaf with the cut shape facing upwards where light strikes.
- 4) Place the plant in sunlight for 3 hours.
- 5) Remove the leaf with a stencil from the plant using a razor blade
- 6) Remove the stencil and carry out the test for starch.

Before testing for starch

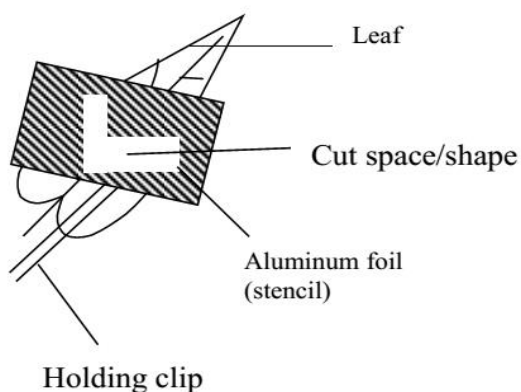

After testing for starch

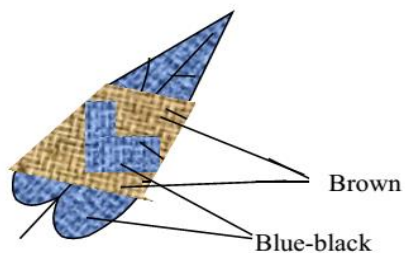

**Observation:**

The parts, which were covered by the stencil, turned brown while the parts exposed to light turned blue-black.

**Conclusion:**

Light is necessary for photosynthesis to take place.

**Explanation:**

Putting the leaf in darkness removes starch in the leaf by all the starch being converted into simple sugars. Putting the plant in light is to allow photosynthesis to take place. Covering the leaf with a stencil is to prevent light from reaching certain parts of the leaf. During exposure to light, the parts covered do not access sunlight and do not photosynthesize while the un-covered parts access sunlight and photosynthesize. Testing for starch helps to find out whether photosynthesis took place or not.

**Experiment 4:****AN EXPERIMENT TO SHOW THAT CARBONDIOXIDE IS NECESSARY FOR THE PROCESS OF PHOTOSYNTHESIS****Apparatus:**

- ❖ Sodium hydroxide (NaOH) / Potassium Hydroxide (KOH),
- ❖ Conical flasks fitted with corks with a hole,
- ❖ well watered destarched plants,
- ❖ Iodine,
- ❖ (99% alcohol)
- ❖ water beaker,
- ❖ white tile
- ❖ Test tubes.

**Procedure:**

- a) The leaves of a potted plant are destarched by keeping the plant in darkness for two days.
- b) The petiole of the leaf (stalk) is passed through the hole in the cork so that the leaf is completely enclosed in a flask containing Sodium Hydroxide.
- c) The Sodium Hydroxide absorbs all Carbon dioxide enclosed in the flask.
- d) The flask is then made air tight by smearing Vaseline at the neck of the flask to prevent any air from entering.
- e) A control experiment is also set up, however here the flask contains water which does not absorb Carbon dioxide.
- f) The plant and the flasks are then placed in sunlight for 6 hours.

g) The enclosed leaves are then removed from the plant and then tested for starch using Iodine solution.

### Experimental set up.

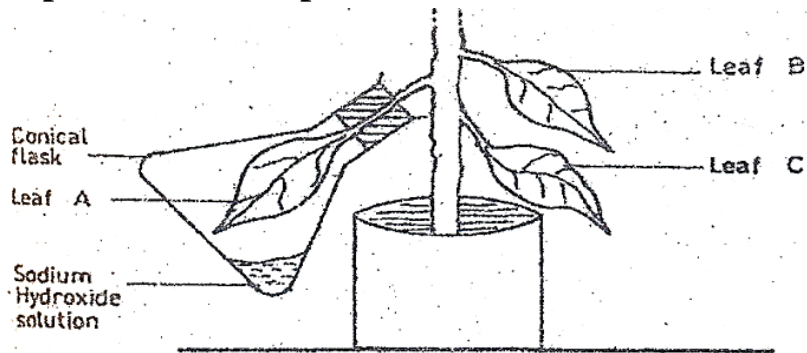

Alternatively

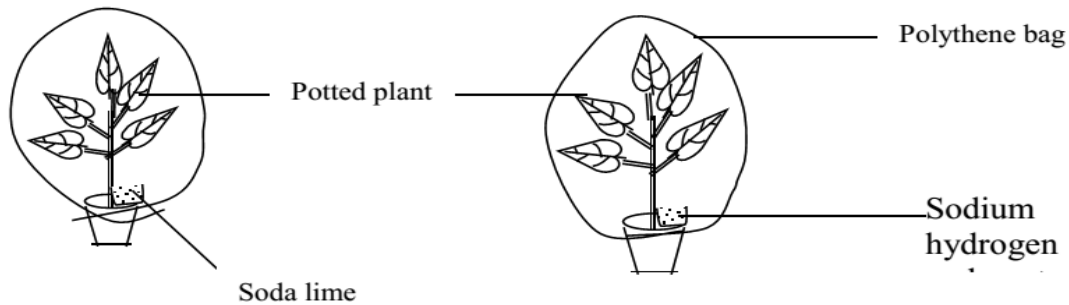

### Observation:

The leaf in the flask containing Sodium Hydroxide solution remains brown (the colour of Iodine persisted) when tested for starch while that (the flask containing water / control experiment) turned blue black.

### Conclusion:

The leaf in the flask containing Sodium Hydroxide didn't contain starch since it lacked Carbon dioxide which was absorbed from the flask by the Sodium Hydroxide solution thus Carbon dioxide is necessary for photosynthesis.

### Experiment 5:

## **AN EXPERIMENT TO SHOW THAT CHLOROPHYLL IS NECESSARY FOR PHOTOSYNTHESIS**

### **Apparatus:**

- A beaker,
- Alcohol,
- white tile
- Iodine,
- test tube, and

➤ Plant with variegated leaves.

A *variegated leaf* is one which has chlorophyll in some parts of the leaf lamina and not in other parts of the same leaf. It has green and yellow patches on the same leaf.

**Procedure:**

- a) After a period of destarching (removing starch) by placing a plant in a dark cupboard for two days, the variegated plant is then exposed to sunlight for about two (2) hours.
- b) The parts of the leaf that are not green are used as the control experiment.
- c) At the end of the two hours, the leaf is removed and then tested for starch.

**Observation:**

The parts that were green are stained blue black with iodine solution while the yellow patches stained brown with iodine (brown is the colour of iodine).

**Conclusion:**

The green parts of leaf contained starch because they contained chlorophyll and thus turned blue black while the yellow patches (non-green parts) did not contain starch because they lacked chlorophyll.

Chlorophyll is thus necessary for photosynthesis.

## **GASEOUS EXCHANGE AND COMPENSATION POINT**

Both respiration and photosynthesis take place in a green plant.

**Photosynthesis equation:**

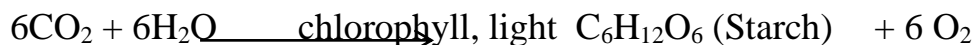

In darkness, Green plants do not photosynthesize however they continue to respire. Here oxygen is used up (through respiration) and carbon dioxide given off and there is an overall net consumption of sugars and starch during respiration.

At low light intensity, some photosynthesis occurs and some carbon dioxide produced in respiration by plants is used up in photosynthesis. However, there is a net loss of Carbon dioxide.

As the light intensity increases, the rate of photosynthesis also increases until a point is reached when all the Carbon dioxide produced during the process of respiration is reused in the process of photosynthesis. This point is called the **compensation point**.

*The compensation point is that point of light intensity at which the rate of Carbon dioxide produced by respiration is equal to the amount of Carbon dioxide consumed during photosynthesis.*

At the compensation point, the rate of photosynthesis is equal to the rate of respiration ie the rate at which food (starch) is manufactured is equal to the rate at

which it is used up in the process of respiration and this means that there is no net gain or loss in the mass of the plant.

## **IMPORTANCE OF PHOTOSYNTHESIS**

Photosynthesis is the method by which food is made from simple inorganic materials.

- (i) Photosynthesis helps to purify the environment by removing excess Carbon dioxide from the atmosphere which is a pollutant.
- (ii) During the photosynthesis process, oxygen is released back into the atmosphere and it is very vital in the respiration process of most organisms.
- (iii) It provides energy. This energy is mainly organic in nature in form of fuels like coal, petroleum, firewood, all of which are products of photosynthesis.

## **Factors that affect the rate of photosynthesis**

The rate of photosynthesis can be determined by considering how much oxygen is evolved by the plant or the amount of oxygen given off by the plant or increase in the weight of the plant due to accumulation of starch. Some of the factors include the following:

### **1) Amount of chlorophyll**

The more chlorophyll, the more the light energy absorbed leading to increased rate of photosynthesis. The less the chlorophyll, the less light energy absorbed leading to decreased rate of photosynthesis

### **2) Amount of CO<sub>2</sub> in the atmosphere**

It is required as a raw material for photosynthesis thus the rate of photosynthesis increases in CO<sub>2</sub> concentration and it decreases with the lowering of CO<sub>2</sub> concentration.

### **3) Light intensity**

The rate of photosynthesis increases with increase in light intensity. And it lowers with decrease in light intensity.

### **4) Temperature**

It is required for the activity of enzymes that control the rate of photosynthesis.

Thus the rate of photosynthesis increases with increase in temperature till the optimum temperature for enzyme action. Beyond which the enzymes are denatured leading to decrease rate of photosynthesis.

### **5) Number of stomata**

The more the stomata, the more the gaseous exchange. This avails more CO<sub>2</sub> to the plant leading to high rate of photosynthesis.

### **6) Surface area for photosynthesis**

The larger the area for photosynthesis (more leaves) the more light energy is absorbed which causes increased rate of photosynthesis.

### 7) Amount of oxygen

The rate photosynthesis decreases with increase in oxygen concentration and it increases with the lowering of oxygen concentration.

### 8) Availability of water

## MINERAL NUTRITION IN PLANTS

Plants need mineral elements for proper growth. Mineral elements are divided into two categories depending on the relative amounts of element needed.

1. Essential macro (elements)
2. Trace micro (elements)

### Essential elements:

These are elements needed in large quantities for proper plant growth, e.g. nitrogen, phosphorus, magnesium, potassium, calcium, sulphur, carbon, hydrogen, oxygen, etc.

### Trace elements:

These are elements need in small quantities for proper plant growth they include manganese zinc boron silicon aluminum copper, molybdenum, and iron.

Plants obtain minerals from mineral salts present in the soil; Mineral salts are absorbed in form of soluble salts e.g. nitrogen as nitrate, phosphorus as phosphates, sulphur as sulphate.

When a particular element is missing in the in the surroundings, a plant shows deficiency signs.

### Elements, their functions and effects of their deficiency

Mineral	Form taken into plant	Function	Deficiency symptoms
Nitrogen	- Nitrates ( $\text{NO}_3^-$ ) -	- Synthesis of amino acids, proteins and nucleotides - Forms part of chlorophyll	Stunted growth, yellow under developed leaves

	Ammonium ion (NH <sub>4</sub> <sup>-</sup> )		
Potassium	K <sup>+</sup>	-Formation of cell membrane and proteins - Opening of stomata	-Yellow and brown edges of leaves -Premature death
Calcium	Ca <sup>2+</sup>	- Development of cell wall - Activates some enzymes. Neutralizes certain acids in the soil.	- Poor root growth -Stunted growth
Phosphorus	PO <sub>4</sub> <sup>3-</sup>	- Formation of ATP - Synthesis of nucleic acids. - Formation of proteins.	-Red leaves
Magnesium	Mg <sup>2+</sup>	-Part of chlorophyll molecule - Activates enzymes.	-Poor root and development of fruits. - Stunted growth.
Iron	Fe <sup>2+</sup> or Fe <sup>3+</sup>	-Synthesis of chlorophyll - Activates enzymes.	-Stunted growth -Yellow leaves and veins remain green
Sulphur	SO <sub>4</sub> <sup>2-</sup>	-Amino acid and Protein synthesis	-Yellow leaves -Stems become weak and slender.
Manganese	Mn <sup>2+</sup>	-Activation of enzymes -Formation of chloroplast membranes.	-Premature death of shoots
Zinc	Zn <sup>2+</sup>	-Activation of enzymes -Forms plant growth substances.	-Poor leaf and stem formation
Boron	Borate	-Uptake of calcium -Cell differentiation.	-Gray colouration -Death of stem.
Carbon	CO <sub>2</sub>	Carbohydrate synthesis	Not common
Hydrogen	H <sub>2</sub> O	Carbohydrate synthesis	Not common
Silicon		Cell wall formation in grasses	-Decrease in weight in cereals
Aluminum		Decrease in cell division	-Stunted growth

Copper		Important in reactions of photosynthesis	-Inhibits respiration and photosynthesis
--------	--	--	--

### CULTURE SOLUTIONS

These are solutions with a balanced concentration of mineral salts. Such solutions are used to investigate the effect of a missing mineral element on plant life. This is done by dissolving all other minerals in water except one whose effect is being investigated.

#### Experimental apparatus for culture of seedlings

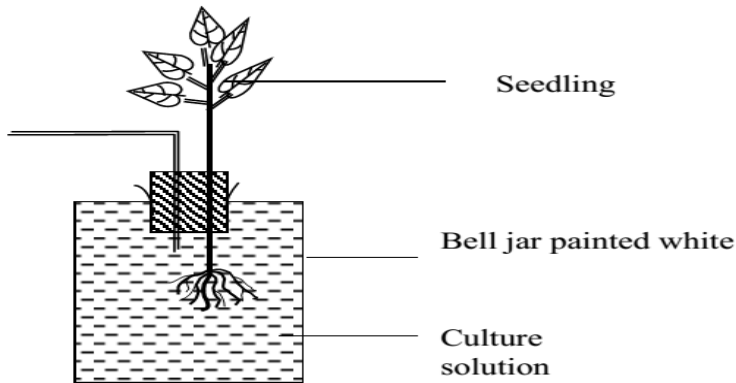

#### Precautions taken:

- 1) Walls of the jar should be painted white to keep light away from the culture in order to prevent the growth of unicellular algae which can bring about shortage of the minerals
- 2) The underside of bung should be kept dry otherwise the stem of the seedling may rot.
- 3) Air must be blown in through the right angled tube every day to provide oxygen for the roots
- 4) The solution should be renewed at the end of every two weeks.

#### A table showing various elements and their deficiency elements

ELEMENTS	ABSORBED AS:	FUNCTION	DEFICIENCY
----------	--------------	----------	------------

Nitrogen	Nitrates, $\text{NO}_3^-$ , Ammonium ions $\text{NH}_4^+$	- Synthesis of proteins, Protoplasm and nuclear acids. - Consistent of chlorophyll and respiratory pigments.	- Stunted growth. - Yellowing of leaves (chlorosis)
Phosphorus	Phosphate, $\text{PO}_4^{3-}$	- Form part of the nuclear acid. - Necessary in nuclear division. - Acts as a buffer in the cell sap.	- Poor root growth. - Poor fruit development. - Stunted growth. - Premature leaf fall.
Calcium	Calcium ions $\text{Ca}^{2+}$	- Activates enzymes - Forms part of the cell wall.	- Poor root growth.
Magnesium	Magnesium ions $\text{Mg}^{2+}$	- Formation of chlorophyll of leaves.	- Yellowing of leaves or chlorosis.
Potassium	Potassium ions $\text{K}^+$	- Opening of the stomata. - It is an enzyme activator.	- Chlorosis of the margins and tips of leaves. - Stunted growth.
Sulphur	Sulphate ions $\text{SO}_4^{2-}$	- forms part of proteins. - it is a constituent of enzymes.	- chlorosis - weak and slender stems
Iron	Iron(II)- $\text{Fe}^{2+}$ (green) Iron(III)- $\text{Fe}^{3+}$ (brown)	- Formation of chlorophyll. - Activates enzymes	- Chlorosis.
Manganese	Manganese ions $\text{Mn}^{2+}$	- It is an activator of enzymes	- Chlorosis between veins
Chlorine	Chloride ions, $\text{Cl}^-$	- Activates enzymes.	- Chlorosis stunted root growth.
Molybdenum	Molybdate ions $(\text{MnO}_4)^{2-}$	Important in Nitrogen fixation as an enzyme activator.	- Chlorosis of lower leaves.
Copper	Copper ions,	- It is a constituent of	- Wilting of leaves

	$\text{Cu}^{2+}$	enzymes	
Zinc	Zinc ions, $\text{Zn}^{2+}$	- Activates enzymes. -It is important in the formation of growth hormones.	-Interveinal chlorosis. - Stunted growth

## MOVEMENT OF MATERIALS IN AND OUT OF THE CELL

Substances like nutrients and excretions move in and out of the cell by:

1. Diffusion
2. Osmosis
3. Active transport
4. Phagocytosis
5. Pinocytosis

Movement of substances depends on the permeability of the cell membrane or cell wall.

### DIFFUSION

This is the movement of molecules of gases and liquids from a region of high concentration to a region of low concentration. Diffusion occurs because small molecules are in constant random motion. Molecules of gases and liquids by random motion tend to distribute themselves evenly, throughout the available space, unlike in solids where molecules are closely packed together and have no freedom of movement. Diffusion only takes place where there is a difference in concentration i.e. where there is a concentration gradient and continues until there is even distribution of molecules.

### EXPERIMENT TO DEMONSTRATE DIFFUSION IN GASES

#### Apparatus

- Wet red litmus paper,
- cotton wool,
- glass tube,
- ammonium solution,
- glass rod

#### Method

Some strips of wet red litmus papers are stuck on the walls of a glass tube as indicated below.

The glass tube is corked at one end and a piece of cotton wool is soaked in ammonium solution and is introduced at the other end which is also plugged.

### **Procedure**

Squares of wet red litmus paper were pushed with a glass rod or wire into a wide glass tube so that they stick to the side and are evenly spaced out. The glass tube is corked at one end the other end is closed with a cork carrying a plug of cotton wool, soaked in ammonia

### **Observation**

The alkaline ammonia gas, diffused along the glass tube, turning the litmus papers blue in succession from 1 to 5, showing that the ammonia gas was diffusing from one end to the other.

**NB:** If the experiment is repeated using more dilute solution of ammonia, the rate of diffusion would be seen to be slower.

## **EXPERIMENT TO DEMONSTRATE DIFFUSION IN LIQUIDS**

### **Materials**

- Glass beaker
- Potassium permanganate crystals
- Water
- spatula

### **Procedure**

Fill a glass beaker with about 50cc of water

Place a few crystals of potassium permanganate at the base of the beaker in the water.

Leave the set up for about 30 minutes.

### **Observation**

After 30-40 minutes, the potassium permanganate color will have spread first at the bottom and later upward to color all the water in the beaker.

### **Conclusion**

Diffusion occurs in liquids.

## **FACTORS AFFECTING THE RATE OF DIFFUSION**

### **1) Concentration gradient**

Concentration gradient is the difference in concentration between the 2 regions where diffusion takes place. The higher the concentration gradient between the two regions, the faster is the rate of diffusion.

### **2) Temperature**

The higher the temperature of the substances (molecules), the faster is the rate diffusion, because temperature increases the kinetic energy of molecules.

### **3) Size/density of molecules**

The smaller the molecules, the faster the rate of diffusion. The denser the particle, the lower the rate of diffusion.

### **4) Distance over which diffusion occurs**

The shorter the distance between the two regions of different concentration, the greater is the rate of diffusion like the alveoli of lungs or the epithelial linings of the ileum are thin to provide a short distance for diffusion thus increasing the rate of diffusion.

### **5) Surface area over which diffusion occurs**

The larger the surface over which diffusion is to take place, the faster is the rate of diffusion e.g. diffusion surfaces like the ileum have numerous villi to increase the rate of diffusion.

## **Types of diffusion**

### **Simple diffusion**

This is the type of diffusion where molecules or ions move freely across the cell membrane without being aided.

### **Facilitated diffusion**

This is where molecules or ions move across the cell membrane by being aided by protein carriers using energy.

### **Significance of diffusion to organisms**

- i) It helps substances to move in and out of cells.
- ii) Plant root hairs take up some salts by diffusion
- iii) Unicellular microorganisms like amoeba, take in oxygen and pass out carbon dioxide through the cell membrane by diffusion.
- iv) Digested food e.g. simple sugars, amino acids, enter the blood from the gut by diffusion.
- v) Once dissolved in blood, the food substances diffuse out of the blood into the cells where they are needed.
- vi) Oxygen diffuses into blood and CO<sub>2</sub> out of blood in the lungs of mammals and gills of fish by diffusion.
- vii) Waste products of metabolisms e.g. nitrogen containing substances like urea, diffuse out of the animal cells into blood.

### **OSMOSIS**

This is the *movement of water molecules from a region of their high concentration to a region of their low concentration across a semi permeable membrane.*

**Or**

It is the *movement water molecules from a solution of low concentration to a solution of high concentration across a semi permeable membrane.*

A semi/partially/selectively permeable membrane is one which can allow the passage of some materials to occur and prevent other materials from passing across it.

**Diagram showing details of osmosis**

When 2 solutions are separated by a semi permeable membrane having small pores, water molecules continue to move from a dilute solution to a concentrated solution through it.

### **Experiment to demonstrate osmosis in an artificial cell**

#### **Materials**

- ✓ Cellophane /visking tube,
- ✓ Capillary tube,
- ✓ Beaker,
- ✓ Syrup or sugar solution,
- ✓ Thread or elastic band,
- ✓ Clamp

#### **Procedure**

- a) Tie one end of the visking tubing using a rubber bung.
- b) Make a sugar solution and pour it into the tubing
- c) Tie the open end of the tubing to the capillary tube using a rubber bung or thread.
- d) Pour some water in the beaker half way full
- e) Insert the capillary tube with the visking tubing into water.
- f) Note the level of the solution in the capillary tube and that of water in the beaker.
- g) Clamp the capillary tube on a retort stand and leave the set up for 30 minutes.

#### **Observation**

In a few minutes, the level of the solution is seen to rise up the capillary tube

### **Interpretation**

Water molecules are passed through the cellophane tubing into the sugar solution by osmosis, thus increasing its volume and forcing it up the capillary tube.

Water acts as a dilute solution

Sugar solution acts as a concentrated solution

Membrane of the visking tubing acts as the semi permeable membrane.

## **EXPERIMENT TO DEMONSTRATE OSMOSIS IN A LIVING TISSUE**

### **Apparatus**

- ✓ Fresh Irish potatoes,
- ✓ knife,
- ✓ Petri dishes,
- ✓ sugar or salt
- ✓ water

### **Procedure**

- a) 3 fresh Irish potatoes are peeled and their ends sliced flat. The interiors are scooped out to form a cup with walls of uniform thickness.
- b) In A, some grains of sugar are placed in the cup, while the other potato B is left empty as a control.
- c) The third potato is boiled to kill or destroy the tissues and also some sugar grains are put in the cup.
- d) All the potato cups are placed in water in Petri dishes. The experiment is let to run for 2-6 hours.

### **End of experiment (2-6 hours)**

The liquid in the cup potato A had risen to form a sugar solution and in the Petri dish, the level had fallen.

In potato B and in the boiled potato, the cups were still empty and the water level in the Petri dishes remained the same.

### **Conclusion**

Osmosis takes place in living tissues and does not take place in boiled tissues. This is because, by boiling, the tissues are destroyed and lose semi permeability

## **Explanation**

Living tissues have cell membrane or cell walls acting as semi permeable membrane and allow water to move through by osmosis while boiling a living tissue makes it impermeable.

## **Terms used in osmosis**

### **Osmotic potential**

This is the ability of a solution to exert osmotic pressure. This describes the concentration of the solution in terms of the ability of water molecules to move hence a solution with high osmotic potential has more water molecules able to move.

### **Osmotic pressure**

This describes the concentration of the solution in terms of the ability of water molecules to move hence a solution with high osmotic potential has more water molecules able to move. This is the pressure exerted by a hypertonic solution to draw water in to its self.

### **Water potential**

This is the concentration of water in a solution. Therefore a solution has a high osmotic pressure if it is highly concentrated and vice versa. This is the ability of a hypotonic solution to loose water to a more concentrated solution.

### **Hypotonic solutions**

This is used to describe a solution containing less solute and more water molecules compared to another e.g. hypotonic solution has a lower osmotic pressure and is generally termed as less concentrated.

### **Isotonic solutions**

These are solutions with the same concentration of salts and water i.e. Solutions with the same isotonic pressure

### **Hypertonic solutions**

This is used to describe a solution with more solutes and less water molecules than the other. A hypertonic solution has a higher osmotic pressure and is generally termed as more concentrated solution.

## Osmosis and cells

### Animal cells

Unlike the plant cells, animal cells lack a cell wall and only have a cell membrane which is weak and non-resistant to high internal pressure.

### Osmosis and red blood cells

When red blood cells are placed in a dilute solution (hypotonic solution) i.e. distilled water, the cells swell up and eventually burst (haemolyse). This is because water moves from the surrounding solution (distilled water) via the semi permeable cell membrane into cells.

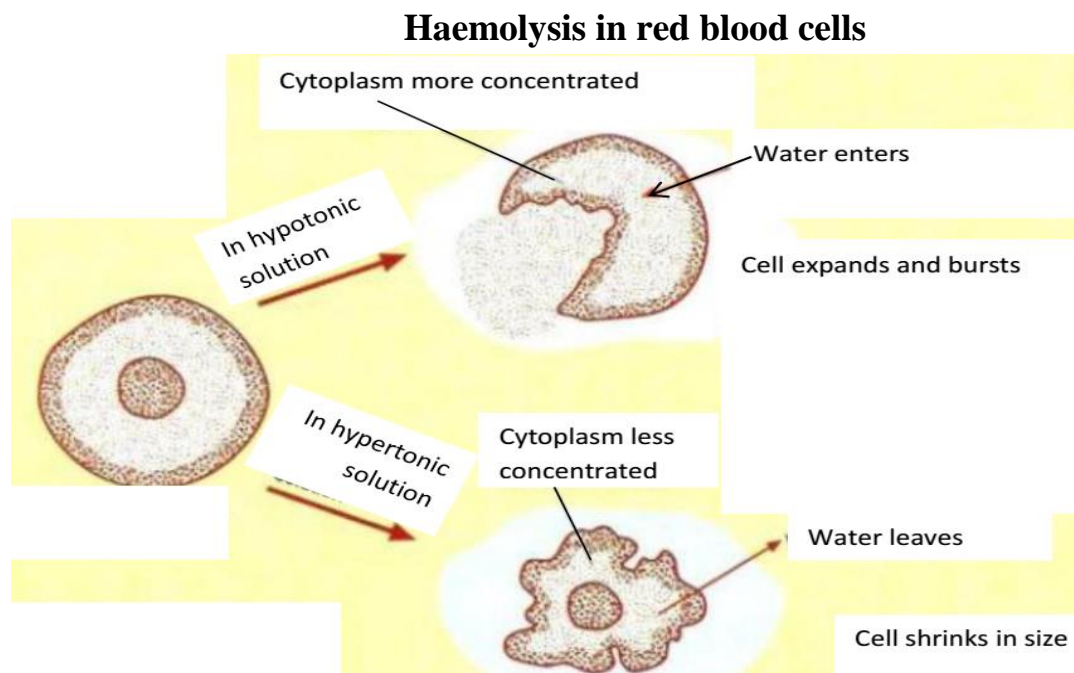

When the red blood cells are placed in a more concentrated solution (hypotonic solution) e.g. a strong sugar solution, water moves out of the cells to the surrounding solution by osmosis. As a result, the cells shrink the process called crenation or laking.

However, when red blood cells are placed in isotonic solution they neither gain nor lose water.

### Turgor

This is the attainment of enough water in the cell to make it expand to its maximum volume.

### **Turgor pressure**

This is the force exerted on the cell wall of the plant cell due to pushing of the cytoplasm as a result of water entering the cell vacuole and expanding.

### **Turgidity**

Is a destination of a cell which has attained enough water and expanded to maximum size.

When a plant cell is placed in a dilute solution (water) than the cell sap, water enters by osmosis through the semi permeable cell wall and cell membrane into the cell sap. The volume of cell sap increases and it makes the sap vacuole expand. This causes the cytoplasm move towards the cell wall and gaining turgidity.

Time comes when all the cytoplasm is pressing against the cell wall and no more water can be absorbed. At this state, the cell is said to have gained full turgidity and the force on the cell wall is called turgor pressure.

### **Diagram showing a cell gaining turgidity**

### **Plasmolysis**

This is the loss of water from the cell to the surrounding causing the vacuole to shrink and cause the cytoplasm to lose contact with the cell wall.

When the cell is in this condition, it is said to be flaccid or plasmolysed. Therefore a flaccid cell is one whose cytoplasm has lost contact with the cell wall due to loss of water from the cell sap of the vacuole.

When the cell is in a more concentrated solution than the cell sap, water moves from the cell sap through a cytoplasm than the cell wall to the surrounding solution. This causes the vacuole to shrink and the cytoplasm to lose contact with the cell wall and the cell is said to be flaccid or plasmolysed.

### **Diagram showing a plasmolysed cell**

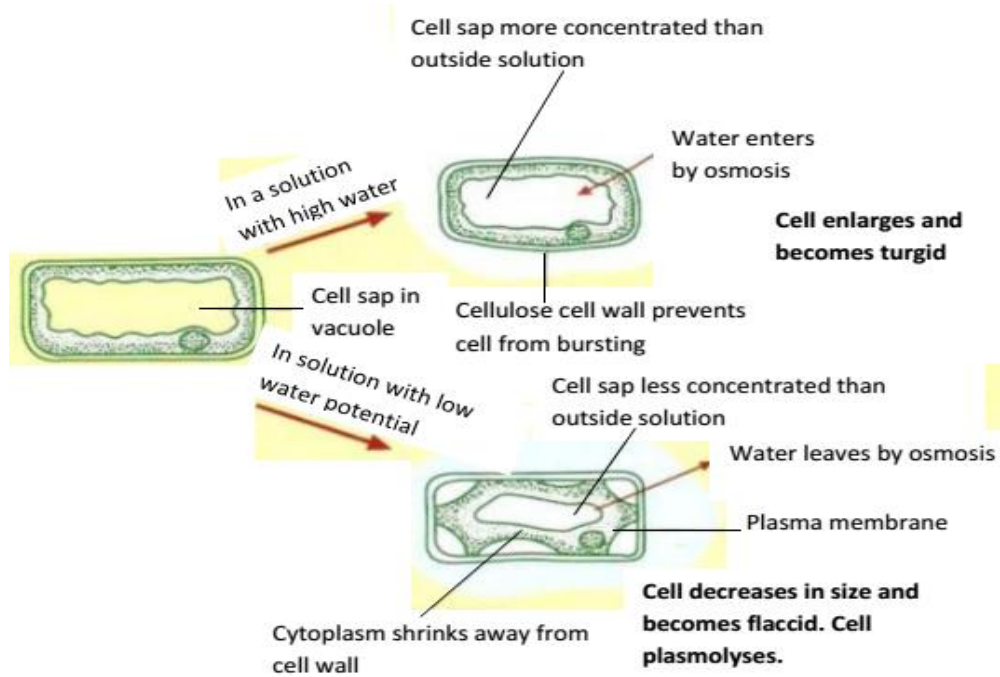

## Experiment to demonstrate turgor and plasmolysis

### Materials

- ✓ Cock borer
- ✓ Four beakers
- ✓ Water
- ✓ Irish potato
- ✓ Razor blade
- ✓ Sugar crystal

## Procedure

- i) Get four beakers and pour  $\frac{3}{4}$  of water in 3 of them and leave one empty.
- ii) Mix the sugar in one beaker to make 5% solution
- iii) Mix sugar in another beaker to make 50% solution
- iv) Leave one with pure water
- v) Use a cork borer to make 4 potato cylinders the same length e.g. 3 cm.
- vi) Name this initial length
- vii) Deep the potato in each cylinder
- viii) Leave the setup for one hour and observe.

## Setup

Remove the cylinder from each beaker and measure each length. Also feel the texture. Tabulate your results in the table below.

Initial length/cm	Final length/cm	Change in length/cm	% change in length	Texture(soft/tough)
4.0	4.3	+0.3	+7.5	Tough
4.0	4.0	0	0	Tough
4.0	3.8	-0.2	-5	Soft/flaccid
4.0	3.9	-0.1	-4	Soft

## Observation

The cylinder in water had increased in length and became tougher.

The cylinder in 5% sucrose solution didn't have any change in length and the texture remained the same

The cylinder in 50% sucrose solution had decreased in length and become soft, flaccid and curved.

The potato in the empty beaker decreased in length.

## Conclusion

Turgor and plasmolysis occur in plant cells.

## Explanation

The cylinder in water increased in length because water molecules moved into it from the surrounding water by osmosis because the cell sap had a higher concentration than the surrounding water.

There was no change in length for the cylinder in 5% sucrose solution because the solution had the same concentration as the cell sap of a potato cylinder hence no net osmosis.

There was a decrease in length for the cylinder in 50% sucrose solution because water molecules moved out of the cylinder which had a lower concentration by osmosis.

There was a decrease in length for the cylinder in the empty beaker because water was lost to the surrounding through evaporation.

### **Significance of osmosis in plants**

- i) Absorption of water by root hairs from soil
- ii) It enhances movement of water from root hairs via the cortex to the xylem.
- iii) For support in non- woody plants
- iv) It facilitates opening and closing of stomata
- v) In germination, the initial absorption of water is by osmosis

### **Significance of osmosis in animals**

- i) It enables movement of water to capillaries in villi
- ii) Movement of water in to unicellular animals
- iii) Movement of water from tissue fluid to the cell
- iv) It enables reabsorption of water into the blood stream via the kidney tubules.

**Note:** many semi- permeable membranes allow the passage of solute and solvents though not to the same extent. All that is required for osmosis to occur is that the solvent molecules move more rapidly than the solute molecules.

### **ACTIVE TRANSPORT**

This is the movement of molecules from the region of low concentration to the region of higher concentration i.e. movement against concentration gradient using energy.

Energy for this process is derived from respiration. Anything that affects the rate of respiration, also affects the active transport e.g. cyanides prevent ATP synthesis.

Active transport takes place by means of carrier molecules in the cell membranes which are protein. The carrier, on reaching the inner part of the membrane releases the molecules and is set free for further transportation.

### **Examples of active transport**

- 1) Up take of mineral salts from soil by plant roots
- 2) Absorption of some food molecules e.g. glucose
- 3) Selective re absorption of molecules e.g. glucose

### **Importance of active transport**

- 1) Used by plant roots or root hairs to absorb minerals from the soil.
- 2) Used in the absorption of food materials from the ileum into the blood stream
- 3) Used in the reabsorption of minerals in the kidney during urine formation
- 4) Used in the secretion and active uptake of ions in the fish gills from fresh water

### **PINOCYTOSIS**

This is the process by which animal cells take in liquid materials into their bodies. Thus it is said to be cell-drinking.

### **PHAGOCYTOSIS**

This is the process by which animal cells take in solid materials. The cell engulfs/invaginates or takes in solid materials and form a food vacuole where the food is digested. The food is absorbed into the cytoplasm and undigested particles are released. It requires energy.

### **Importance of phagocytosis**

- 1) Used by amoeba during feeding
- 2) White blood cells destroy pathogens by phagocytosis
- 3) Unicellular animals egest undigested material by phagocytosis.

### **aTRANSPORT IN PLANTS AND ANIMALS**

This refers to the movement of materials from one part of the organism to another. In plants, it is called translocation. It involves diffusion, osmosis and active transport in simple organisms and active transport in simple organisms and transport systems in large higher organisms, (Vascular & circulatory systems).

### **THE NECESSITY FOR TRANSPORT SYSTEM**

All living things need a continuous exchange of certain substances between their cells and the environment e.g. oxygen, food, materials carbon dioxide, waste products.

In large complex animals, most of the cells are located far from the surface thus the need for a transport system.

Flat worms are flattened to shorter distance for transport.

### **Requirements of transport system**

- The materials to be transported
- The medium of transport
- The channels of transport
- Energy

### **Materials to be transported**

In animals, they include respiratory gases oxygen and carbon dioxide, nitrogenous excretory products e.g. uric acid, nutrients e.g. glucose, amino acid.

In plants, they include oxygen and carbon dioxide.

Mineral elements for plant growth

Manufactured food (autotrophs)

Absorbed food (in saprophytes)

Vitamins, amino acids auxins

### **The medium of transport**

The medium of transport in plants and lower animals is water and it is blood in vertebrates and in a few invertebrates like arthropods, annelids (earth worm).

### **The channels of transport**

In most animals, these are blood vessels, in others e.g. earth worms, it is the body cavity (coelom). In higher plants, there is a vascular system or system of xylem and phloem.

### **Energy**

Circulation of blood in animals requires energy supplied from respiration used in pumping of the heart and muscle contractions.

## **TRANSPORT IN PLANTS**

Transporting tissue in plant is xylem and phloem. It involves movement of water, salts and organic molecules (manufactured food).

### **THE XYLEM**

This Consists of xylem vessels and tracheids. Xylem vessels develop from cylindrical cells, arranged end to end, in which the cytoplasm die and cross- walls disappear leaving a dead empty tube. Through this:

Water, mineral salts, move from roots, stems, up to leaves. Xylem vessels are strengthened by lignin in their walls.

This strength gives support to the soft tissue of roots, stems, and leaves: it also prevents collapse of the vessels under tension as sap pressure changes.

#### **Structure of xylem**

#### **Tracheids**

They are similar to xylem vessels; except that they are typically 5 or 6 sided. In cross- section, instead of being open at each end, their tapering end walls are perforated by pit (tiny holes in lignified walls). Even xylem has pits in their walls.

NB

Tracheids are more primitive- they are found in gymnosperms e.g. cypress where there is control of transpiration, for water does not move very fast through them.

#### **Characteristics of xylem tubes**

- a) Consist of dead tubes
- b) They are hollow
- c) Its walls are lignified
- d) Has no protein filaments
- e) Has no cytoplasm
- f) Transports water and salts
- g) Transports water and mineral salts in one direction

#### **Types of thickenings in the xylem vessels/tissues**

##### **1. Annular lignification**

## **2. Spiral lignification**

## **3. Reticulate lignification**

### **PHLOEM TISSUE**

This Consists of sieve tubes and companion cells. The sieve tubes are formed from cylindrical cells arranged end to end. Unlike the xylem vessels, the cross walls do not disappear but develop perforations of enlarged pits forming sieve plates. The protoplast of a sieve tube / elements remains living; although its nucleus disintegrates as the cell differentiates. Each sieve tube is closely associated with companion cells which are complete cells.

The companion cells regulate a metabolic activity of the sieve tubes.

#### **Characteristics of phloem tissue/tube**

- a) Consist of living cells
- b) Have a thin cytoplasm
- c) Associated with companion cells
- d) Consist of sieve cross walls
- e) Consist of protein filaments
- f) Transport food materials
- g) Transport materials in opposite direction

#### **Structure of the phloem tissue**

Sieve tubes have perforated cross walls called sieve plates. In between the plates are sieve pores which allow food substances to pass from one cell to another along the cytoplasmic filaments (protein filaments). Adjacent to sieve elements are the

companion cells which provide the sieve tube with energy to transport the food substances.

### Differences between xylem and phloem

Xylem	Phloem
Consists of dead cell walls xylem and phloem	Consists of living cells
Vessels are lignified	They are non- lignified
Consists of open ended vessels and tapering tracheids	Consists of sieve tubes with sieve plates and cytoplasmic strands
Transports water and mineral salts	Transports manufactured food
Transportation depends on transpiration pull	Depends on respiratory energy

### Structured comparison between xylem and phloem

#### Similarities

- Both have cells without nucleus e.g. vessels and tracheids in xylem and sieve tubes in phloem.
- Both are perforated, i.e. xylem is bordered with pits and phloem has sieve pores in the sieve plates
- Both tissues are surrounded by parenchyma cells as packing tissues.

#### Differences

xylem	Phloem
Consists of dead cells.	Consists of living cells
Both tracheids and vessels have lignified walls	Walls are not lignified
Vessels are often ended and tapering tracheids	Sieve tubes have sieve plates perforated with sieve pores.
Do not have companion cells	Have companion cells.
Lack micro filaments	Have micro filaments

### Function comparison

- In both, materials are transported in solution form.
- In both, transport involves use of energy e.g. in xylem, transpiration pull depend on solar energy and in phloem it depends on respiratory energy.

#### Differences:

<b>Xylem transport</b>	<b>Transport in phloem</b>
Occur in one direction i.e. up the plant	Occur in two directions i.e. up and down.
Depend on transpiration pull/ solar energy	Depend on respiratory energy.
Transport water and dissolved minerals.	Manufactured food and auxins
Occur in dead cells	Occur in living cells
Both tracheids and vessels are used	Only sieve tubes are used
Occurs in cells with lignified walls	Not lignified cells

### **TRANSPORT OF WATER FROM SOIL TO THE LEAVES**

Up take of water also called absorption is a continuous stream through the plant.

Root hairs in the soil are surrounded by a film of water containing mineral salts/ soil solution.

The soil solution once inside the root hair vacuole is called cell sap and is a strong solution than the soil solution( has a lower osmotic potential and the cell membrane of the root hair is semi permeable.

The above conditions enable water to move from the soil, passes through the cell membrane in to the vacuole by osmosis.

Addition of water to the root hair all which is absorbed by osmosis makes it to attain higher osmotic potential as compared to the neighboring cells with stronger cell sap.

This enables water to move to and from the root hair to other cells of the cortex and through the cortex cells until it reaches the xylem which conducts water up the plant.

The water rises up the xylem by the following forces.

#### **Capillarity**

This is the ability of water to move up the fine tube. It is usually caused by the surface tension but because the capillary tube is narrow, the water rise is limited.

#### **Cohesion – tension forces**

This is a force of attraction between the molecules of the same substance.

Cohesion between water molecules allows water in a continuous column without breaking.

This occurs because as water is lost by transpiration from the leaves, the water potential at the top of xylem vessels falls below that at the bottom of the xylem in the root. Water is now pulled by this potential difference because of the cohesion of the water molecules.

### **Adhesion**

This is the force of attraction between molecules of different substances (unlike) Adhesion forces between walls of xylem and water molecules support a considerable weight of water within the xylem tissue and prevent the xylem vessels from collapsing.

### **Root pressure**

This is regarded as the pressuring force of the water up the stem from the roots

The root pressure is an active process confirmed by the fact that:

It occurs only in living tissues/ plants.

It is affected by the same factors that affect respiration in living cells like oxygen supply, temperature, starch supply and the presence of respiratory poison like cyanides.

The root pressure theory has been suggested as a result of a common observation that water tends to exude from the cut stem indicating that some pressure in a root is actually pushing the water up. This pressure has been measured using a manometer attached to the stem and it is this force which is normally called root pressure.

The root pressure depends on the type of plant species e.g. vines root pressure is up to 200 kpa has been demonstrated.

However, like capillary, root pressure is not sufficient on its own to push water to the leaves of the plant at the top of the tree and can slowly cause guttation in transpiring herbaceous plants.

### **Transpiration pull**

This is the pulling force generated by the evaporation of water from the leaves.

This is caused when the cells of the spongy mesophyll layer in the leaf lose water by evaporation into the air spaces causing their cell sap to become more concentrated and as a result they draw the water from the surrounding cells by osmosis.

These in cells in turn get water from the xylem in the veins and then water from the xylem moves to replace the lost water by evaporation. This evaporation sets up the passing action on water in the xylem called transpiration pull.

### **HOW IS THE ROOT HAIR ADAPTED TO ITS FUNCTION OF WATER ABSORPTION**

- i) The root hair is slender and flexible and can therefore flow between the soils particles.
- ii) They are numerous which increase the surface area available for water absorption.
- iii) They lack the cuticle which would restrict water absorption.
- iv) They are long and narrow which increases surface area to volume ratio that increases the rate of water absorption.
- v) The cytoplasm of the root hair contains numerous mitochondria where respiration occurs to release ATP needed for active transport of mineral salts from the soil solution to the cytoplasm of the root hairs.
- vi) All the centre of the root hair is a vascular tissue which transports water and mineral salts to the rest of the plant.
- vii) The cell sap of the root hair contains sugars, amino acids and salts, and so its concentrated than the soil solution and this low osmotic potential enables water to entre it by osmosis

#### **Longitudinal section of the root hair**

Root hairs vacuoles contain a high concentration of solute than the surrounding water. Water is absorbed by root hairs by osmosis. This causes the root hair, vacuoles to become less concentrated than those of the adjacent cortex cell. Water is then passed into the cortex cell by osmosis. Water then enters the xylem tissue. Water moves through the root cortex from cell to cell by 3 path ways:

- i) Most of the water flows along the cell vacuole.
- ii) Some water travels in the cytoplasm.
- iii) Some water moves from vacuole to vacuole

The inner most region of cortex is made up of the endodermis strip which controls the movement of water from the cortex into the xylem.

## **EXPERIMENT TO SHOW THAT WATER TRAVELS UP THE PLANT THROUGH THE XYLEM**

### **Apparatus**

- Small plant with flowers,
- beaker,
- water,
- dye,
- knife, and
- microscope

### **Procedure**

- A small plant with light coloured flowers is placed in a beaker containing water with a dye.
- It is allowed to stay in the water for 24 hrs
- The stem and the roots are cut transversally and then observed under a microscope

### **Observation**

The dye appears in the flower and along the veins of the leaves.

It is observed that the xylem in the stem and roots are stained with the dye.

## **EXPERIMENT TO DEMONSTRATE ROOT PRESSURE**

### **Apparatus**

Potted plant with actively growing shoot, glass tubing, water, retort stand, rubber tubing.

### **Procedure**

- a) Cut the shoot of an actively growing potted plant leaving about 5 cm of stem above the ground/ soil
- b) Firmly fix the glass tubing about 30cm long to the cut end of the stem using rubber tubing
- c) Partly fill the glass tubing with coloured water and support it with a retort stand
- d) Make the level of water in the glass tubing
- e) Water the soil well and place the apparatus in a warm place for 3 hrs
- f) Control experiment is a dry plant.

## **Diagram**

### **Observation**

The level of coloured water rises in the glass tubing.

### **Conclusion**

Water was absorbed by the plant and travelled upwards the stem due to root pressure

### **Importance of water to the plant**

- Raw material for photosynthesis
- Solvent for mineral salts and oxygen that enable them to diffuse into the roots.
- It is a constituent of the cytoplasm and all sap of the growing plants
- Provides turgidity which provides support in non woody plants
- Cools the leaves of the plants during transpiration

### **ABSORPTION OF MINERAL SALTS BY THE ROOT HAIRS**

Mineral salts are moved in the plant in the xylem in solution with water. Roots absorb mineral salts in form of ions by diffusion and active transport. Active transport is the movement of the materials against the concentration gradient by the use of energy released from respiration.

### **TRANSPORT OF THE PRODUCTS OF PHOTOSYNTHESIS**

The process by which the soluble products of photosynthesis are carried in plants is called translocation. Translocation is the movement of manufactured food from the site of photosynthesis. Throughout the plant, sugars and amino acids are transported in the phloem from the leaves to the growing parts of the plant or storage organs. Food substances may also move from the storage organs to the growing regions of the plants. In the phloem, food substances may move upwards/down wards.

### **The process of translocation process**

The process of photosynthesis leads to accumulation of food substances in leaves. This causes a high turgor pressure within the leaves.

Food substances in the roots are used for respiration or they are stored in the storage organs and these results in the low turgor pressure in the root cells. The difference between turgor pressure in the roots and leaves enables the food substances to move from leaves to other parts of the plant by a process called mass flow which is the major process of translocation.

There is also a minor process i.e. active transport where the sugars e.g. sucrose are actively transported from leaves to the storage organs.

### **EVIDENCE TO SHOW THAT FOOD MADE IN LEAVES IS TRANSLOCATED BY THE PHLOEM**

#### **1) The Ring Experiment:**

Remove a ring of the bark from the stem at a point between the ground and the upper leaves. Leave another plant with the ring on.

The plants are left to stand for one week after which the observation is made.

#### **Observation**

The upper part of the stem of the ring plant swells immediately above the ring while the lower part of the stem remains unswollen.

The unringed plant remains unchanged.

#### **Conclusion**

The phloem transports manufactured food.

#### **Explanation**

When a ring of a base is cut, the phloem tissue is removed along with it since it's found within the bark. This cuts off the supply of manufactured food to the lower

parts of the plant as a result, the phloem in the upper part of the stem will transport the food to the part just above the ring. The food will then accumulate in this part hence it will swell.

When the ring is removed, the tree or plant also dries because the food supply to the root is cut off therefore the stored food in the roots gets exhausted then the roots die.

## **2) Feeding Aphids:**

When the proboscis of the sucking aphid is cut, it is found to have penetrated into the phloem tube and when its contents of the proboscis are analyzed, it is found to contain products of photosynthesis (sucrose) which are transported to the bark through the phloem.

## **3) Radio Active Tracers:**

If a plant is exposed to CO<sub>2</sub> labeled with radioactive C-14, the C-14 becomes incorporated into the end products of photosynthesis which are subsequently detected in the stem. That these substances are confined to the phloem and can be shown by cutting sections of the stem, placing the sections in contact with photographic film and making auto radiographing it is found that the sites of radioactivity correspond precisely to the positions of the phloem.

# **TRANSPIRATION**

This is a process by which plants lose water in form of water vapour mainly through leaves to the atmosphere. Transpiration can also occur from flowers.

## **TYPES OF TRANSPIRATION**

- 1. Stomatal transpiration:** This is the transpiration through the stomatal opening. This contributes up to 80-90% of water lost.
- 2. Cuticular transpiration:** This occurs through the leaf cuticle which amounts for about 20% of the water lost.
- 3. Lenticular transpiration:** This occurs through the stem pores called lenticels and accounts for about 0.1% of the water lost.

Water can also be lost from the plants as water droplets in a process called guttation through special structures called hydrates found on leaf types or margins

## **AN EXPERIMENT TO SHOW THAT WATER IS LOST MAINLY FROM LEAVES DURING TRANSPIRATION**

### **Apparatus**

Potted plant,

Polythene paper,

String,

Cobalt (ii) chloride paper or anhydrous copper (ii) sulphate.

### **Procedure**

- a) Tie polythene around the tin of the potted plant. Using a string to avoid evaporation of water from the soil surface.
- b) Tie transparent polythene around the leafy shoot of the plant.
- c) Set up another similar control experiment but with leaves removed and dry plant.
- d) Leave the experiment to settle for 3 hours in bright sunlight.
- e) Remove the polythene around the leafy shoot and test the drops of liquid inside the polythene using anhydrous copper (ii) sulphate / cobalt (ii) chloride paper.

### **Diagram**

### **Observation**

A vapour forms inside the polythene and turns into drops / liquid which turn anhydrous copper (ii) sulphate from white to blue or blue cobalt (ii) chloride paper to pink.

No vapour is observed from experiment with no leaves / dry plant.

### **Conclusion**

Transpiration occurs from the leaves

### **Note:**

A bell jar may be used instead of polythene

A control experiment may also be a covered pot where the plant shoot has been cut off.

## **EXPERIMENT TO COMPARE TRANSPIRATION RATES ON BOTH SURFACES OF A LEAF**

### **Apparatus**

- ✓ Potted plant,
- ✓ glass slide
- ✓ Cobalt (ii) chloride paper
- ✓ Rubber bands

### **Procedure**

- a) Fix pieces of Cobalt (ii) chloride paper on the upper and lower surfaces of a leaf still to the plant with glass slides.
- b) Tie the slides using the rubber bands
- c) Note the time taken for the Cobalt (ii) chloride paper on each slide to turn / change colour from blue to pink.

### **Diagram**

### **Observation**

The lower surface cobalt (ii) chloride paper turns pink faster than that on the upper surface.

### **Conclusion**

The lower surface has a higher transpiration rate than the upper surface

This is due to numerous stomata on the lower surface of the leaf.

## **FACTORS AFFECTING RATE OF TRANSPIRATION**

### **1) Temperature**

Increase in temperature increases the rate of transpiration. This is because high temperatures provide latent heat of vaporization which increases the evaporation of the water leading to more water to be lost.

Temperatures also increases the kinetic energy of the air molecules around the leaf which causes them to move further apart and this increases rate of diffusion from the leaf

## **2) Relative humidity**

Humidity is the amount of water vapour in the atmosphere. As humidity increases, the rate of transpiration decreases. This is because the environment becomes saturated with the water vapour. The water then can be absorbed from the plant decrease which reduces the rate of transpiration.

## **3) Wind**

Rate of transpiration is higher in windy air than in still air. This is because wind helps / assists to remove water vapour in the air around the leaf and creates more spaces that can take up more water vapour.

However, if the wind speed becomes too high transpiration stops due to mechanical closure of the stomata and the cooling effect the wind has on the leaf.

## **4) Light intensity**

Rate of transpiration is high during the presence of light and low in the dark.

This is because high light intensity result in high rate of photosynthesis which increase the sugar concentration in the guard cells which lead to wide opening of the stomata leading to more evaporation from the plant ( also light provide heat which increase evaporation from the leaf stomata.

## **5) Availability of water**

This affects the turgidity of the guard cells i.e. more water more turgidity which leads to opening of stomata and enable more water loss and to high transpiration rate.

## **6) Atmospheric pressure**

Humidity decreases with decrease in atmospheric pressure. Hence decrease in atmospheric pressure greatly increases the rate of transpiration due to decreased humidity.

### **Non environmental factors**

## **7) Distribution of stomata**

The rate of transpiration is low when more stomata are on the lower side and is higher when more stomata are on the upper side of the leaf.

### 8) Number of stomata

The greater the number of stomata, the higher the rate of transpiration because more water vapour is lost through the stomata.

### 9) Surface area for transpiration

Plants with wide/broad leaves have a larger surface for transpiration thus they experience a higher rate of transpiration. But that with small leaves e.g. desert plants have a small surface area hence low rate of transpiration.

### 10) Thickness of the plant cuticle

The rate of transpiration decreases with increase in thickness of the cuticle. For that reason, plants found in deserts have extremely thick cuticle than those in tropical regions.

## MECHANISM OF STOMATAL OPENNING AND CLOSURE

Stomata open during day and close at night.

During the day, photosynthesis takes place in the guard cells in the presence of sunlight. This leads to accumulation of sugars in the guard cells which lowers their water potential.

As a result, water moves into the guard cells by osmosis from the neighbouring epidermal cells. Turgor pressure of the guard cells increases which causes their outer thin elastic walls to expand and pull the inner thick inelastic walls outwards, hence opening the stoma.

### Diagram showing a stoma open

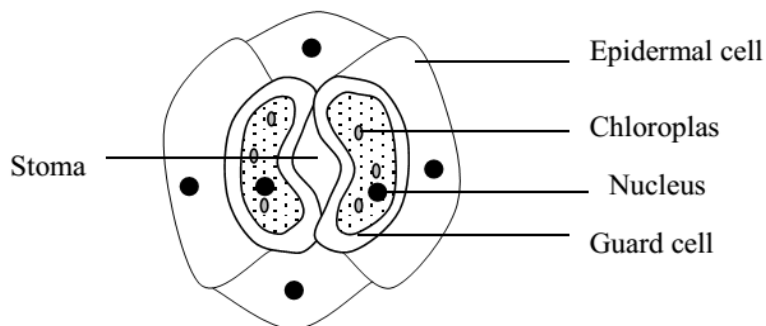

At night, there is no photosynthesis due to absence of light. Osmotic pressure inside guard cells decreases/ water potential increases. This causes the guard cells to lose water to the neighbouring epidermal cells by osmosis. Turgor pressure

inside guard cells lowers, making the inner walls to move closer together and the stoma closes.

### Diagram showing a stoma open

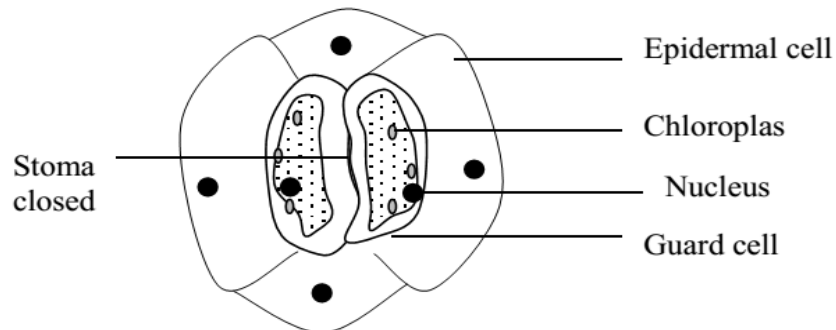

## EXPERIMENTS TO MEASURE THE RATE OF TRANSPIRATION

### 1. THE WEIGHING METHOD

This is where a potted plant is weighed on the balance to determine the difference in weight before and after transpiration. The difference in weight shows the amount of water lost by the plant in a given period of time.

### 2. POTOMETER METHOD

This is done using an instrument called a potometer. The potometer works on assumption that water lost from the leaves during transpiration equals water absorbed by the plant.

Therefore the potometer:

- ✓ Directly measures the rate of water uptake/ absorption of the shoot and
- ✓ Indirectly measures rate of water loss / evaporation of water/ transpiration from the leaves.

### Set up of a potometer

#### Procedure:

- a) A leafy shoot of a plant is cut under water to prevent air bubbles from entering as these would block the xylem vessels.

- b) The potometer is filled with water.
- c) The leafy shoot is fixed into the cork and then fitted into the mouth of the potometer vessel.
- d) Vaseline is smeared at the interface of the shoot and the cock to prevent entry of air into the apparatus.
- e) A single air bubble is introduced at the open end of the capillary tube by touching the open end briefly under water and then release.
- f) At a given mark  $V_1$ , reached by the air bubble, a clock is started and after a given time  $t$ , the new position of the air bubble  $V_2$ , is noted and recorded.

$$\begin{aligned} \text{Rate of transpiration} &= \frac{\text{distance moved air bubble}}{\text{Time taken}} \\ &= \frac{V_2 - V_1}{t} \end{aligned}$$

- g) In any given set of environmental conditions, about 3 experiments can be performed, resetting the air bubble after each experiment by opening the tap and then close.
- h) Average rate is then calculated and taken as the rate of transpiration in that environment.
- i) The set up can be moved to different environmental conditions and rate of transpiration determined in the same way.

### **Precautions taken when using a potometer in order to ensure accurate results**

1. A leafy shoot should be used to ensure significant water loss.
2. The shoot must be cut under water to prevent air from entering and blocking the xylem vessels.
3. The whole apparatus must be full of water.
4. A single air bubble must be present in the capillary tube for each experiment.
5. Air bubble must be reset to zero mark before each experiment
6. A graduated capillary tube must be used in order to clearly read results.
7. Air bubble should not cross the T- function at the reservoir

### **ADAPTATIONS OF PLANTS TO REDUCE TRANSPIRATION RATE**

- i) Shedding off of leaves in deciduous plants to reduce transpirations since most of it occur from the leaves
- ii) Reducing the number, size and distribution of the stomata and only on lower epidermis
- iii) Structural adjustments in stomata i.e. some plants have sunken stomata and others have hairy stomata which reduces evaporation from them.
- iv) Reduction in leaf structure i.e. some plant leaf are reduced to narrow or thorny / spines structures that reduce surface area over which transpiration occurs.

- v) Rolling of leaves to create a humid atmosphere around the stomata in order to reduce water loss.
- vi) Possession to thick cuticle of the leaves to prevent water loss through it.
- vii) Thick leaves that store water
- viii) Changes in the rhythm of stomata opening i.e. they close during day and open at night when temperatures are very low.
- ix) They shed off their leaves in extremely hot environment to cut down water loss.
- x) Reversed opening and closing of stomata. Stomata open at night and close during the day when it's rate of transpiration is likely to be higher.

### **IMPORTANCE OF TRANSPIRATION (FUNCTIONS / ADVANTAGES)**

- a) Results in the absorption of water and its movement up the plant to aid processes like photosynthesis.
- b) Contribution to maintenance of continuous stream of water throughout the plant.
- c) Transported water keeps the plant cells turgid and cools the plant.
- d) Results in the movement of mineral salts up the plants to where they are needed.

### **DISADVANTAGES / DANGERS OF TRANSPIRATION**

- a) Excessive water loss from the plant may lead to wilting, drying and even death of the plant.
- b) Water may lead to over cooling which affect metabolic activities
- c) Over absorption of mineral salts with water lead to soil exhaustion.

### **TRANSPORT OF MATERIALS IN ANIMALS**

The transport system in animals consists of a number of routes through which specific materials are distributed

Smaller organisms (protozoa) that have large surface area to volume ratio carry out transport by simple diffusion.

Transport system is important in large organisms (multicellular) because the increased size of the organisms and the great distance over which materials are supposed to move makes diffusion rate slow which in turn make it inadequate for the distribution of these materials

To overcome the physical limitation on size placed by diffusion, multicellular animals have the major adaptations.

They have organs that provide a large surface area for absorption of nutrients such as small intestines and exchange of gases such as lungs/ gills, without a great

increase in total body volume. They have a transport (circular) system within the body, so that substances can be carried to cells that need them and waste products removed more quickly than in diffusion.

The circulatory system in mammals consist of closed tubes and heart which provide the forces that drives the fluid (blood) in these which include Arteries, capillaries and veins.

### **Plants do not use a circulatory system because:**

- The oxygen requirement of the plant is very low as compared to mammals.
- Plants have a continuous series of airspaces throughout the body opening to the atmosphere by the stomata and ventricles.
- In plants oxygen from the air diffuses through the stomata opening in to the airspaces and from the air spaces in to the cells by diffusion. And the oxygen dissolved in the soil water also diffuses through the root hairs in to the plant sap.
- The carbon dioxide produced during respiration is used up during photosynthesis.

## **Types of transport systems in animals**

### **1. Closed circulatory system:**

Closed circulatory system e.g. in earthworm, fish and mammals have blood enclosed in tubes

Here blood is pumped by the heart to tissues through the arteries and return to the heart through the veins.

The arteries and veins are connected by capillaries which are thin walled

The body cells do not come in to direct contact with blood but are bathed in the tissue fluids. Substances diffuse out of the blood which is confined to blood vessels in to the tissue fluid and then across to cells membrane in to the cell.

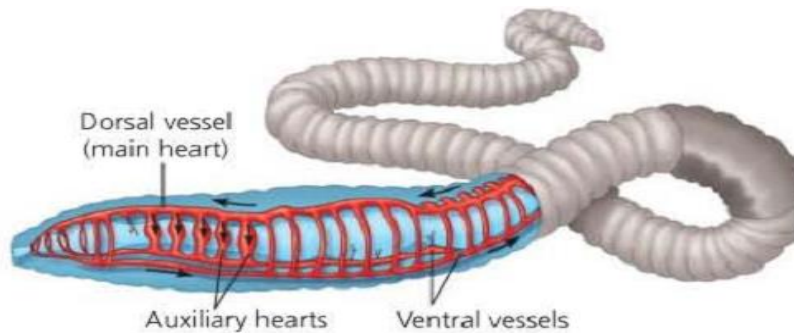
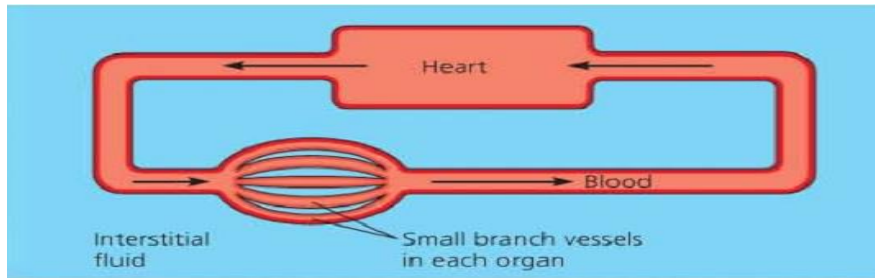

### **Advantages of closed circulatory system**

- ✓ Distribution of blood/materials is easily controlled.
- ✓ Blood moves or flows very fast leading to quick supply of materials.
- ✓ Blood flows at a high pressure leading to an effective system.

### **Demerits of closed circulatory system**

- ✓ It requires a special heart whose pumping action provides pressure for movement of blood.
- ✓ Blood movement meets a high resistance within vessels.

## **2. Open circulatory system e.g. in molluses and arthropods**

Here the artery that leaves the heart is very short and blood empties in a large blood filled space called haemocoel. Then blood from these spaces return to the heart through the short veins.

The organism cells are directly bathed in blood and materials diffuse out of the blood in to each cell across the cell membrane.

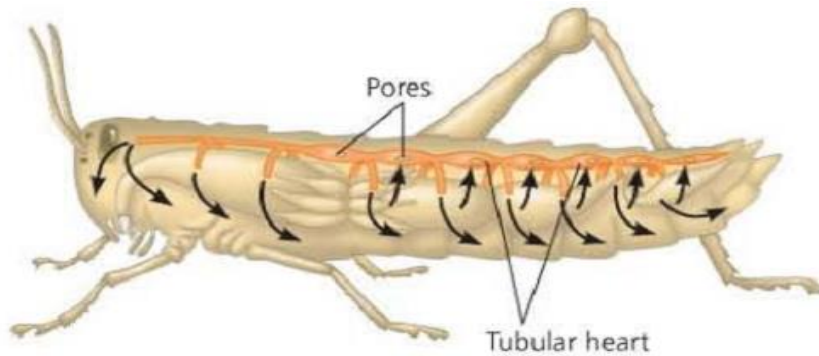
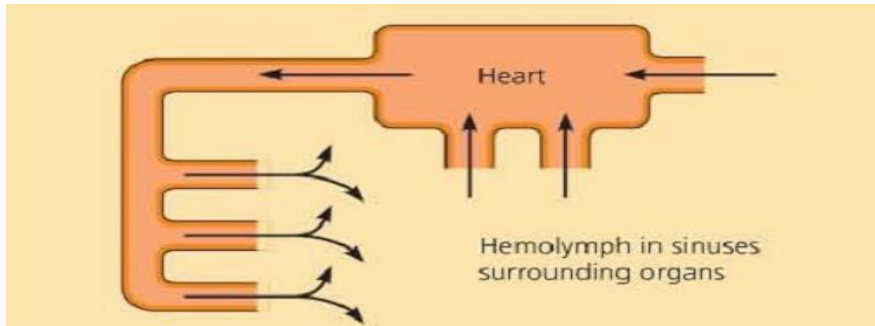

### Advantages of open circulatory system

- ✓ Easy diffusion of materials due to absence of vessel barriers.
- ✓ It does not require special pumping hearts since blood is flowing through cavities with less resistance.

### Disadvantages of open circulatory system

- ✓ Blood flows sluggishly/slowly leading to slow supply of materials.
- ✓ Blood flows at a low pressure.
- ✓ There is little control over distribution of materials or blood.

## TYPES OF CLOSED CIRCULATORY SYSTEM

### 1. Single circulatory system

This is the type of circulation where blood from the body cells flows once through the heart and goes back to the body cells. It has a heart with only two chambers i.e. one atrium and one ventricle e.g. in fish.

Diagram illustrating single circulation

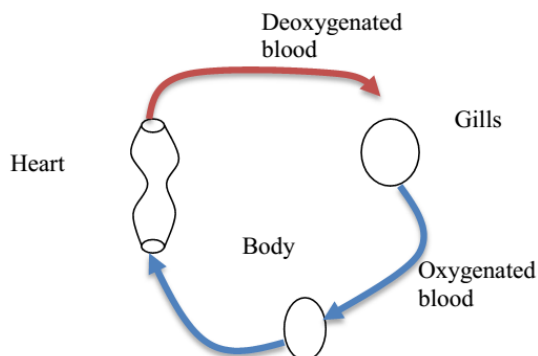

The demerit of single circulation is that blood moves very slowly leading to slow supply of materials. Blood pressure is also greatly reduced by gill capillaries.

## **2. Double circulatory system**

In a double circulatory system, blood is pushed out in the heart in to a series of capillaries and the blood passes through the heart twice in each circulation. It involves two separate circulation ie

- Pulmonary circulation to the lungs
- Systemic circulation to the rest of the body

That is, blood from the right ventricle is pumped into the lungs through the pulmonary artery and return to the left atrium via the pulmonary vein and this is called **pulmonary circulation**.

Blood from the left ventricle is pumped through the aorta to the rest of the body and returns to the right atrium through the vena cava and this is called **systemic circulation**

Double circulation is further divided into 2;

- Incomplete double circulation
- Complete double circulation

### **Incomplete double circulation:**

Is a system in which blood flows through the heart twice for every complete cycle through a three-chambered heart. The heart has one ventricle through which both oxygenated and deoxygenated blood from the two atria flow. Mixing of oxygenated and deoxygenated bloody is prevented by ridges present in the ventricle. This system of blood circulation is found in amphibians e.g frogs.

### **Diagram of incomplete double circulation**

### **Complete double circulation**

Is a type of circulation where blood flows through the heart twice within a four-chambered heart for every complete cycle of circulation. Mixing of oxygenated and deoxygenated blood is prevented by a wall called septum. It is found in birds, reptiles and mammals.

### **Diagram showing complete double circulation**

### **Advantages of double circulatory system:**

- ✚ High blood pressures required for fast flow of blood is reached than in open circulation.
- ✚ Gives more rapid circulation since blood is returned rapidly to the heart for pumping.
- ✚ There is complete separation of oxygenated and deoxygenated blood which improves efficiency of oxygen distribution and can therefore sustain the high metabolic rate required by such animals that possess it.
- ✚ Blood is pumped directly to where it's needed

### **NB:**

The amount of blood flowing to a certain organ can be regulated by changing the diameter of the blood vessel.

### **Summary of transport in animals**

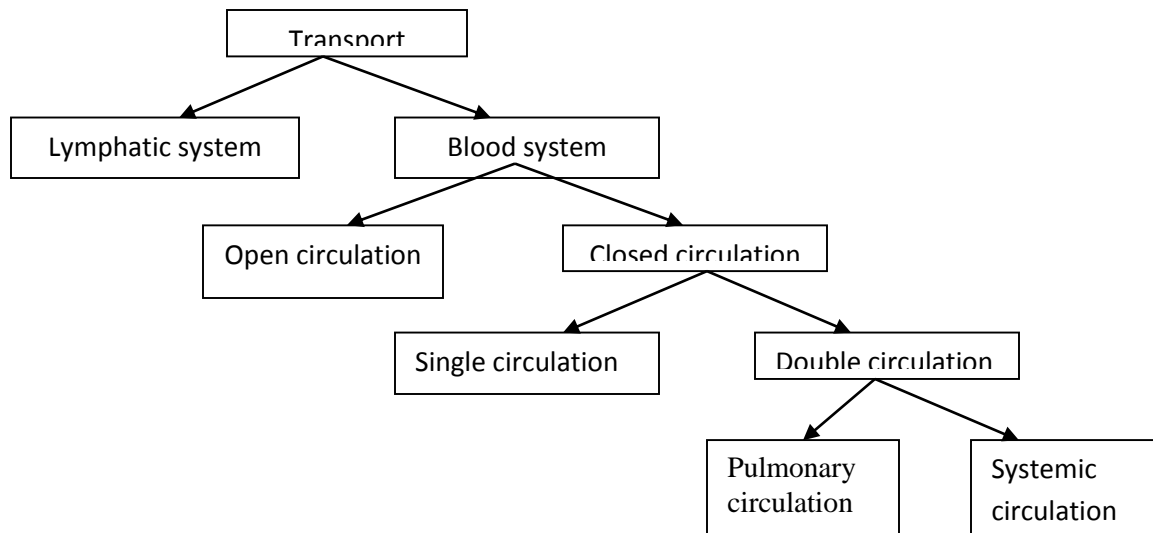

### **THE MAMMALIAN CIRCULATORY SYSTEM**

The continual circulation of blood in mammals is due to the pumping action of the heart.

The circulation of blood in mammals is divided into two. That is;

- 1. The pulmonary circulation;** this is the circulation of blood from the heart to the lungs and from the lungs back to the heart. It is the simplest circulation where blood moves a very short distance. This type of circulation involves the pulmonary artery and pulmonary vein.
- 2. The systemic circulation;** this is the circulation of blood from the heart to the rest of the body apart from the lungs and from the rest of the body back to the heart.

**Structure showing the flow of blood in a mammal**

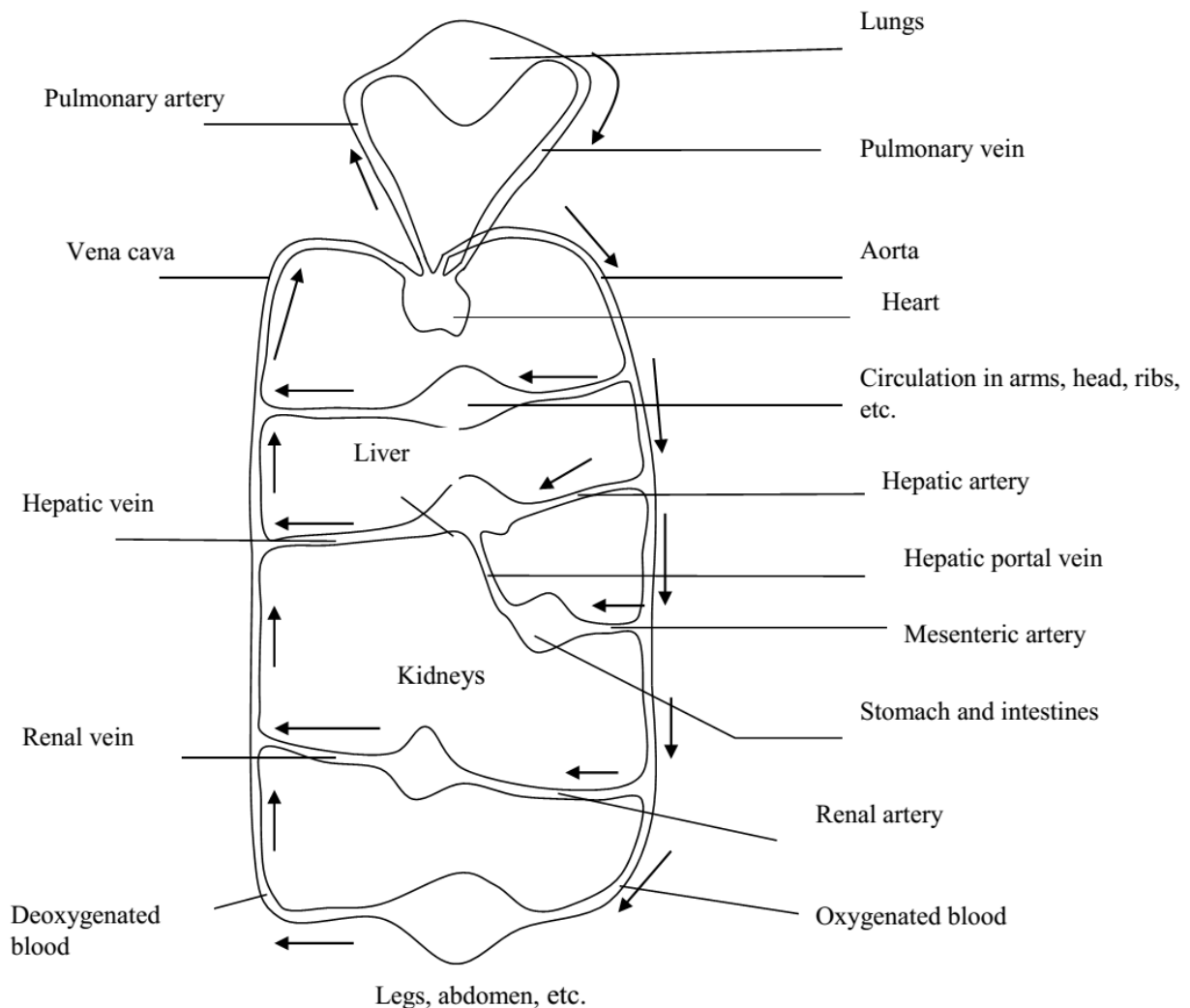

## BLOOD VESSELS

These are the tubes that carry blood throughout the body and they include: arteries, veins, and capillaries

Arteries and veins both have three layers in their walls but the layer of the muscles (elastic tissue) is much greater in arteries than in the veins.

### 1. ARTERIES:

These carry blood from the heart to the body capillaries. Arteries divide into smaller vessels called arterioles which then divide repeatedly to form capillaries.

#### Characteristics of arteries

- Has three layered wall. These are strong to withstand the higher pressure as resulting from the pumping action of the heart.
- They have fibrous outer wall so as to withstand high pressure
- They are found deeply in the body.
- They have a pulse beat corresponding to the heart beat.
- Their walls are elastic to allow stretching due to high blood pressure.
- They have no valves except at the base of the pulmonary artery and aorta.
- They have narrow lumen than veins which maintains blood flow at high pressure.
- They carry oxygenated blood except the pulmonary artery and umbilical artery.
- They all carry blood from the heart to other parts of the body.

#### Structure of an artery in cross section

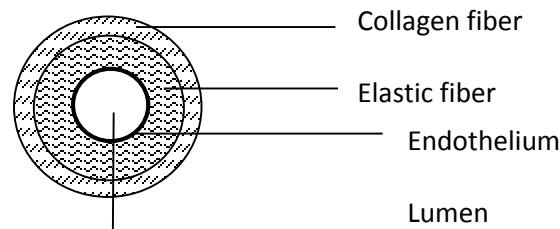

### 2. CAPILLARIES

These are the smallest blood vessels with thin walls to allow diffusion of materials between blood and the tissue fluid.

They connect arterioles to venules.

They pass very close to the cells taking to the cells food, oxygen, and mineral salts etc as well as taking away carbon dioxide, urea and other waste products from the cells.

They are responsible for the exchange of materials between blood and cells, because their walls are permeable allowing water, dissolved food substances to pass through except proteins because they have large molecules.

Blood pressure reduces in them as a result of their resistance, and blood flows in them slowly without pulse.

The capillaries network is so dense and the capillaries unite to form large vessels called venules which join to form veins.

#### **Adaptations of capillaries to its functions**

- They have a large surface area for exchange of materials.
- They have very thin walls for faster diffusion of materials.
- They have a high diffusion gradient leading to rapid diffusion of materials.
- Slow movement of blood in capillaries makes exchange of materials efficient.

#### **Characteristics of capillaries**

- They carry both deoxygenated and oxygenated blood.
  - They have a small lumen.
  - They have permeable thin walls to allow diffusion of materials.
  - They have no valves.
  - Blood flows slowly.
- 
- There is a decrease in pressure.

#### **Cross-section through a capillary**

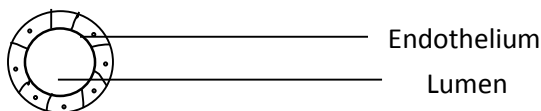

### **3. VEINS**

These carry blood from tissues to the heart. The pressure in them is steady and less than in arteries. All veins carry de-oxygenated blood except pulmonary vein. Blood in the veins flows slowly after losing pressure in the capillaries; however the sluggish flow of blood is maintained by:

- Possession of valves which prevent back flow.
- Having a wide lumen that offers a low resistance to blood flow.
- Action of skeletal muscles against veins as they contract during movement increases blood pressure in veins.
- Inhaling lowers the pressure in thoracic cavity leading to flow of blood towards the heart.

#### **Characteristics of veins / Adaptations**

- They have wide lumen to encourage flow of blood at low pressure.
- They have thinner walls than arteries which are adequate to withstand low pressure.
- They have valves at intervals along their length which prevent blood from flowing backwards / maintain flow of blood in one direction.
- They are not capable of constricting.
- They transport deoxygenated blood except the pulmonary vein and umbilical vein.
- They have less elastic muscles.
- They are found near the body surface.

### Cross-section through a vein

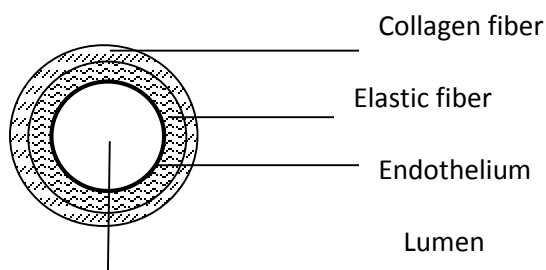

### DIFFERENCES BETWEEN ARTERIES, VEINS AND CAPILLARIES

#### Structural:

Artery	Veins	Capillaries
Have thick walls with smooth muscles	have thin walls with smooth muscles	Have thinner walls with smooth muscles
have more elastic fibres	Have few elastic fibres	Do not have elastic fibres
Have smaller lumen relative to diameter	Have a wider lumen relative to diameter	Have largest lumen relative diameter
Have no valves except at the base of aorta	Have valves throughout their length	Have no valves
Can constrict	Can't constrict	Can't constrict
Walls not permeable	Walls not permeable	Walls permeable

#### Functional

Artery	Vein	Capillaries
Carry blood away from the heart	Carry blood towards the heart	Carry blood to and from the heart

Carry oxygenated blood except pulmonary artery and umbilical artery	Carry deoxygenated blood except pulmonary vein and umbilical vein	Carry both oxygenated and deoxygenated blood
Blood flow at high pressure( flow in pulse)	Blood flow at low pressure	Blood flow at intermediate pressure
Blood flow in pulse	Blood does not flow in pulse	Blood does not flow in pulses

## **THE MAMMALIAN HEART**

Its function is to pump blood around the body. The whole heart is surrounded by the pericardium which has two layers between which is the pericardial fluid that reduce friction between them.

The heart is made of tissues called cardiac muscles which have the potential to contract rapidly.

It's divided in to four chambers. The upper chambers are called atrium / auricle and the lower chambers are each called ventricle.

The heart is divided in to sections ie left and right by a muscular septum whose function is to prevent mixing of oxygenated and deoxygenated blood

Movement of blood in the heart is maintained in a single direction ie from the auricle to ventricle and then to blood vessels.

Blood flow in one direction in the heart is maintained by the presence of valves.

The auricles receive blood from all parts of the body while the ventricles pump blood to the body e.g. the left atrium receives oxygenated blood from the pulmonary vein and pump it to the left ventricle through the bicuspid valve.

The right atrium receives deoxygenated blood from the rest of the body from the vena cava and pumps it to the right ventricle via the tricuspid valve.

The ventricle walls are more muscular (have thicker walls) than those or the auricles because the auricle pump blood to shorter distance i.e. to the ventricle while the ventricles pump blood longer distances i.e. to body and lungs.

The walls of the left ventricle that pump blood in to the systemic circulation are thicker than those of the right ventricle which pump blood to pulmonary circulation.

### **Flow of blood through the heart**

Blood flows in to the heart from the rest of the body via the vena cava to the right atrium which pumps it to the right ventricle via the tricuspid valve.

The right ventricle pumps blood to the pulmonary artery to the lungs and blood flows back to the left atrium via the pulmonary vein which pumps it to the left ventricle via the bicuspid valve and then finally pumped to the rest of the body via the aorta.

## LONGITUDINAL SECTION OF THE HEART

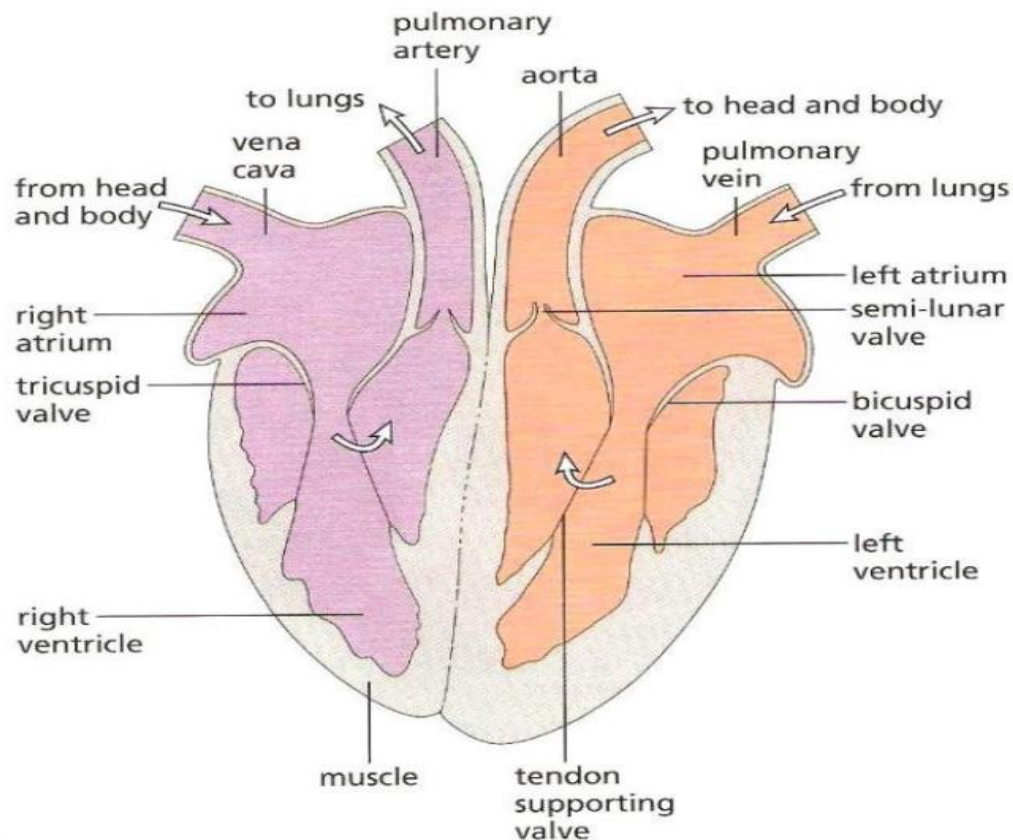

## THE CARDIAC CYCLE

This refers to the sequence of events by which the heart pumps and is refilled with blood. The cardiac cycle involves two phases:

- Re-filling of the heart with blood
- Pumping of blood

The pumping action of the heart consists of alternate contraction and relaxation of cardiac muscles in the walls of the heart. Contraction of cardiac muscles is called *systole* while relaxation is called *diastole*.

During diastole, the cardiac muscles in the walls of the atria relax and expand; blood from the vena cava and pulmonary vein enter the atria and becomes filled with blood. The walls of the ventricles relax and expand while those of the atria contract, forcing blood from the atria into ventricles via bicuspid and tricuspid valves as semilunar valves remain closed.

## **Diagram**

***Reference: introduction to biology. Pg 99 fig 19.10 (a)***

During systole, cardiac muscles of the ventricles contract, forcing blood out of the heart via the semi lunar valves into the aorta and pulmonary artery. At this time, the atria relax and expand in order to be re-filled with blood. The cuspid valves close against high blood pressure to prevent the back flow of blood into the auricles. The closure of the valves produces the heart sound termed as ***lub***.

## **Diagram**

***Reference: introduction to biology. Pg 99 fig 19.10 (b)***

After expelling blood, ventricles relax and their pressure lowers compared to aorta and pulmonary artery pressure.

This would cause back flow of blood to the heart but is prevented by sudden closure of the semi lunar valves. The closure of the semi lunar valves causes a second heart sound called ***dub***.

The 2 sounds ***lub and dub*** are so close and often described as ***lub-dub*** and they form a single heartbeat.

## **Initiation and control of the heart beat**

Contraction of the heart is initiated by heart, heart muscles / cardiac muscles themselves.

Therefore the heart muscles are myogenic i.e. the rhythmic contraction arise from within the tissue itself.

Heart beat is controlled by collection of cells in the right atrium called pacemakers located in the sino artrio node (SAN) which are controlled by nervous impulse from the medulla oblongata of the brain that change the rate of heart beat.

### **Factors affecting the heart beat rate**

- Exercise.
- Lack of hormones in the body e.g. adrenaline
- State of health and diseases e.g. malaria
- Age i.e. its faster in infants than adults.
- Body size i.e. it is faster in small organisms than large
- Sex i.e. faster in female than in male.

NB: In normal adults at rest, heart contracts about 70 / 72 times per minute.

### **BLOOD PRESSURE**

This is the force with which blood flows from one part of the body to another. The blood pressure is due to the pumping action of the heart as experienced by the blood vessels. The narrow blood vessels experience high blood pressure and wide vessels experience low blood pressure. Sometimes fats accumulate in the blood vessels making their lumens narrow. This increases blood pressure and it is the major cause of high blood pressure in fat people, however small people also experience high blood pressure. This is due to conditions like stress, anxiety, fear, etc. These conditions tend to increase the rate of heartbeat and more blood is pumped to the blood vessels causing high pressure in them.

### **BLOOD**

Blood is a connective tissue made up of cells suspended in a fluid matrix called *plasma*.

There are two types of cells in blood i.e. **White blood cells (leucocytes) and red blood cells (erythrocytes)**. The **platelets (thrombocytes) are fragments of cells**.

In an adult human being, there are five to six liters of blood with blood making up approximately 10% of the body weight.

#### **Main components/nutrients of blood**

1. Red blood cells/erythrocytes/red corpuscles
2. White blood cells/eucocytes/white corpuscles
3. Platelets/thrombocytes
4. Plasma

### **General importance of blood in the bodies of animals**

1. It transports oxygen from the lungs to all parts of the body.
2. It transports digested food from the ileum to other parts of the body for use.
3. It transports Carbon dioxide from the tissues to the lungs.
4. It transports nitrogenous wastes from the liver to the kidney where they are excreted.
5. It transports hormones from their site of production to where they perform their functions.
6. It distributes heat and aids in temperature control.
7. It prevents infection by transportation of white blood cells.
8. It regulates the amounts of chemicals such as glucose in the body.
9. It prevents loss of fluids and cells through forming blood clots.

## **THE RED BLOOD CELLS (ERYTHROCYTES)**

### **Characteristics of Red Blood Cells:**

- ❖ They have hemoglobin molecules which carry oxygen from the lungs to the tissues.
- ❖ They lack nuclei
- ❖ They have thin cell membranes which thinness reduces the diffusion distance for gases.
- ❖ They are manufactured from the red bone marrow
- ❖ On average, red blood cells last for four month after which they are destroyed by the liver to form bile pigment and the iron in haemoglobin is stored in the liver
- ❖ They have a biconcave disk shape
- ❖ They are approximately 5 million/mm<sup>3</sup> of blood.

### **Importance of Red Blood Cells:**

They transport oxygen from gaseous exchange surfaces to the tissues

They transport carbon dioxide from tissues to the gaseous exchange surfaces.

### **Adaptation of Red Blood Cells to carry out their function**

- They are biconcave in shape so as to avail a large surface area to volume ratio for absorption of oxygen.
- They have hemoglobin molecules that bind to oxygen and transport it from the lungs to the tissues.
- They have a thin membrane which reduces the diffusion distance for the respiratory gases in and out of the cells.
- They lack nuclei which provides enough space for packaging of haemoglobin
- They lack mitochondria and generate their ATP exclusively by anaerobic respiration to prevent them from using the oxygen they are carrying.

- They have an enzyme, carbonic anhydrase which plays a role in carbon dioxide transport
- They are numerous per  $\text{mm}^3$  to increase surface area for transportation of oxygen
- They have flexible membranes which make them able to squeeze through capillary networks as they exchange materials they transport with the surrounding tissues.

**NB:** The concentration of red blood cells increases as one climbs up a mountain because the concentration of oxygen in the air reduces with increase in height above sea level. So the body adapts by producing more red cells to increase the available total surface area to bind and carry oxygen to the tissues regardless the reducing oxygen concentration main.

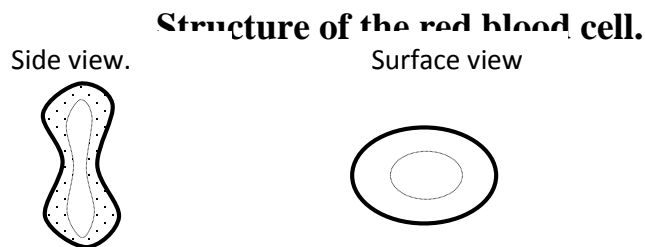

Red blood cells are made from the red bone marrow of short bones in adults and in the foetus, red blood cells are made in the liver. They last for approximately four months after which they are taken to the liver or spleen for their destruction. They are more numerous than any other cells in the blood. Red blood cells are responsible for transporting oxygen in the body.

### **THE WHITE BLOOD CELLS (LEUCOCYTES)**

These are blood cells made from the white bone marrow of long bones. They are also made in the spleen and lymphatic system. They are responsible for defense of the body against infection. They are fewer in blood than the red blood cells.

#### **Characteristics of white blood cells**

- i) They have no definite shape (they are amoeboid)
- ii) They have a nucleus even at maturity.
- iii) They are relatively few in blood but their number increases when the body is attacked by an infection.
- iv) They lack haemoglobin.
- v) They feed on foreign particles by Phagocytes

White blood cells are divided into two major categories. These are;

1. Phagocytes. These are white blood cells with a lobed nucleus. They ingest and destroy germs by phagocytes.
2. Lymphocytes. These are white blood cells, which defend the body by producing antibodies.

### **Structure of a white blood cell**

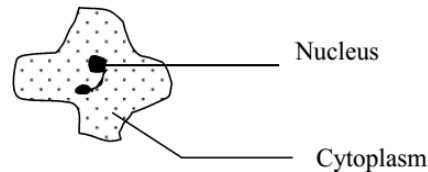

### **Production of red and white blood cells**

The red blood cells are manufactured from the red bone marrows in adults. Old red blood cells are taken to the liver for destruction.

White blood cells are manufactured from the white bone marrows of long bones. Some white blood cells are manufactured from the lymph nodes. Worn out white blood cells are also taken to the liver for destruction. In the foetus, the liver manufactures blood cells.

### **Action of white blood cells on the foreign particles**

Some white blood cells attack and destroy the foreign particles directly by themselves. These are called phagocytes and they destroy the foreign particles by Phagocytosis. In this process the white blood cells form pseudopodia, which they use to engulf the foreign particle by Phagocytosis.

After engulfing the foreign particle, a food vacuole is formed into which digestive enzymes are produced. The enzymes break down the particle and the important materials are absorbed by the white blood cell while the wastes are excreted out of the cell through the contractile vacuole.

### **Illustration of Phagocytosis**

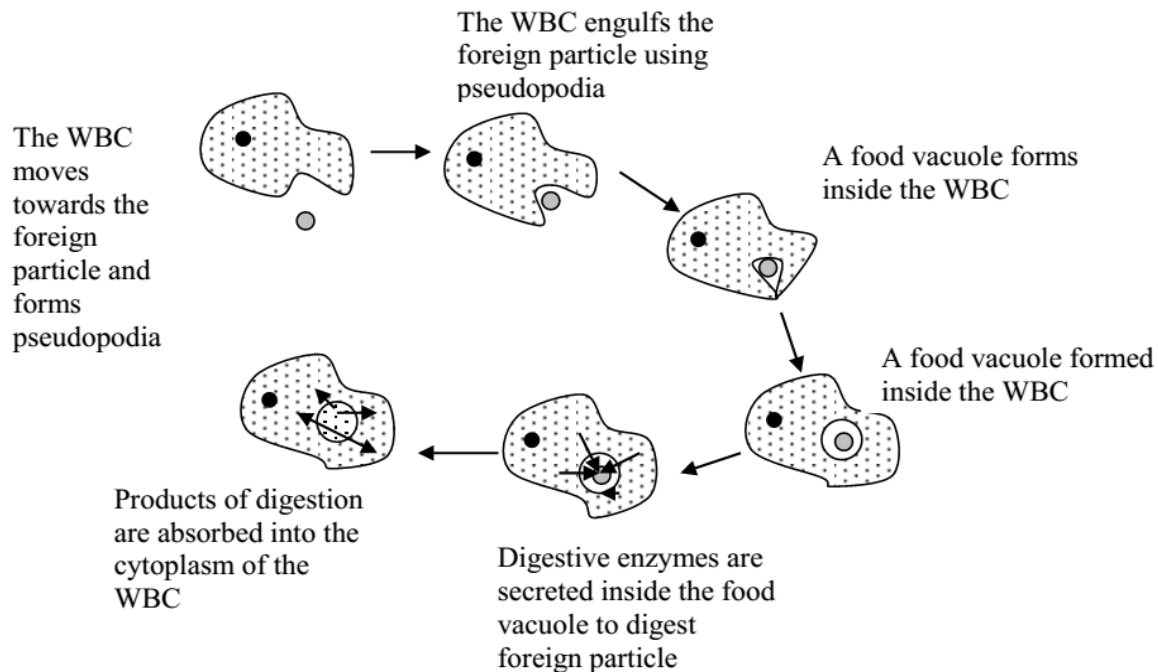

Some white blood cells destroy foreign particles by releasing antibodies, which destroy the particles. White blood cells, which produce antibodies, are called lymphocytes. There are four types of antibodies produced.

- 1) **Opsonins**; these attach to the outer surface of the foreign particle and make it easier for phagocytic white blood cells to ingest them.
- 2) **Agglutinins**; these cause the foreign particles to stick together. In this condition the foreign particles cannot invade the tissues.
- 3) **Lysins**; these destroy bacteria by dissolving their outer coats.
- 4) **Anti-toxins**; these combine with and so neutralize the toxins produced by foreign particles.

### **THE PLATELETS (THROMBOCYTES)**

These are blood cells formed as fragments in the bone marrows during the formation of red blood cells. They are responsible for blood clotting.

#### **Characteristics of platelets**

1. They are cell fragments.
2. They are spherical in shape.
3. They do not have a nucleus.
4. They do not have haemoglobin.

#### **Functions:**

They play a role in blood clotting which protects the body against excessive loss of blood and entry of pathogens through the injured part. *Blood clotting is the*

*process by which blood stops oozing out of a cut or wound.* It is important because of the following reasons.

1. It prevents excessive loss of blood from the body.
2. It is a step towards healing of cuts and wounds.
3. The blood clot creates a barrier to prevent entry of bacteria and other pathogens in the body.

### **The Process of Blood Clotting:**

When blood is exposed to air as a result of a cut or wound, the platelets in the blood at the damaged tissue stimulate the release of a chemical called **thromboplastin (thrombokinase)**. In the presence of **calcium ions** and **vitamin K**, **thromboplastin** stimulates the conversion of **prothrombin** to thrombin enzyme. **Thrombin** then catalyzes the conversion of soluble blood protein **fibrinogen** to the insoluble form **fibrin**. Fibrin forms fibers, which form a mesh and trap blood cells and proteins. This mesh dries to form a scab, which is called the blood clot.

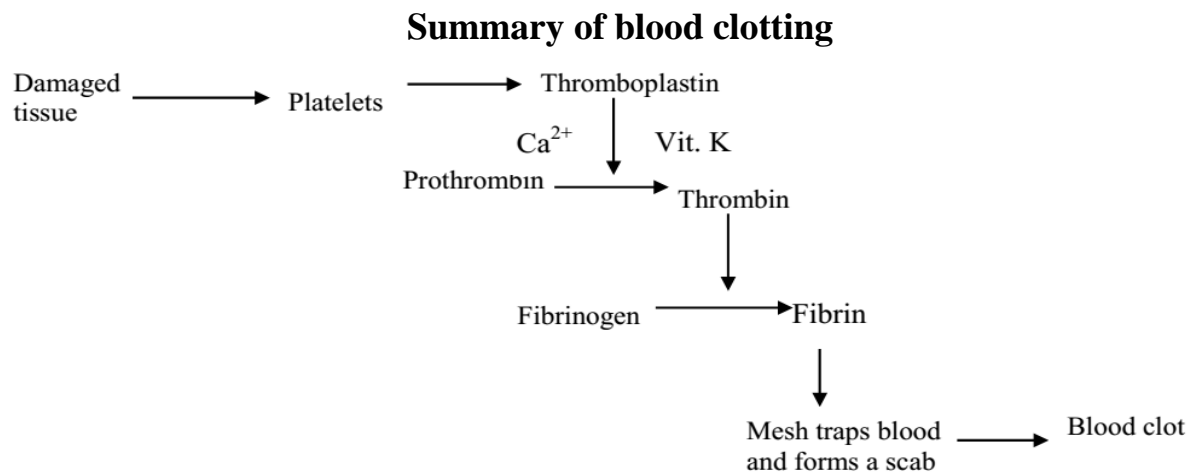

### **BLOOD PLASMA**

This is the fluid part of blood. It is made up of;

a) A soluble protein

A soluble protein called **fibrinogen** that plays a role in blood clotting.

j) Serum

k) This is a watery fluid containing a variety of substances transported from one part of the body to another e.g. hormones, lipids, enzymes, urea carbon dioxide, plasma, proteins, amino acids etc.

#### **Use of Blood plasma:**

- ❖ To transport hormones from gland producing them to the target sites.
- ❖ To transport food nutrients from the gut to the other parts of the body.

- ❖ To transport antibodies to the infected parts of the body.
- ❖ To transport Urea from the liver to the Kidneys for excretion.
- ❖ To transport carbon dioxide from the body muscles to gaseous exchange system.
- ❖ To transport heat from the liver and body muscles to other body parts hence maintaining a constant body temperature range.
- ❖ To transport platelets to injured sites on the body so as to initiate blood clotting.
- ❖ To distribute salts around the body so as to maintain the body's electrolytes balance.

### **CAPILLARY EXCHANGE, FORMATION OF TISSUE FLUID AND LATER LYMPH.**

As blood flows from arterioles into blood capillaries. Pressure builds up in the capillaries forcing small molecules like food materials and the fluid part of blood to leave the capillaries and enter the intercellular spaces, leaving behind large molecules like proteins in plasma and cells.

Once the fluid is in the intercellular spaces of tissues, it is no longer called blood but tissue fluid.

Once formed, the tissue fluid surrounds the cells. Body cells then get their requirements e.g. glucose, oxygen, etc. from the tissue fluid and they add excretory materials to the fluid.

Some of the fluid returns in to the capillaries and the other is drained in to a system of narrow channels called lymph vessels. The fluid in these vessels is now called lymph. Lymph is therefore, tissue fluid in the lymph vessels.

### **THE LYMPHATIC SYSTEM**

This is part of the vascular system. It forms the second type of circulation. Most of the tissue fluid as explained above goes back into the blood capillaries and the remainder enters the lymphatic system and becomes lymph fluid. The lymph fluid is transported through lymph vessels. The lymph vessels are similar to veins but they have more valves than the veins. The movement of the lymph fluid through the lymph vessels is due to the contractions of the surrounding muscles. As they contract and relax, they squeeze the lymph vessels to gain the force by which lymph moves. The walls of the lymphatic vessels have pores, which allow the entry of cell, wastes and bacteria. Before reaching the blood, lymph passes through the lymph nodes where the wastes and bacteria are removed.

The lymph joins the blood circulation via the thoracic ducts, which join the vein in the neck. The right thoracic duct drains its contents of the right side and that of the

left drains the left side. The lacteals of the ileum are also connected to the left thoracic duct.

### **Functions of the lymphatic system**

1. It transports fatty acids and glycerol from the ileum to the heart where they join the blood system.
2. It carries excretory substances from tissues to the blood stream.
3. It produces white blood cells, which assist in defense of the body.
4. It filters out bacteria before they reach the blood stream.
5. Transports hormones from glands to other body parts.

### **Differences between the lymphatic and blood system**

<b>Blood circulatory system</b>	<b>Lymphatic system</b>
Has a heart which acts as a pump	Has no pump
Blood flow is two way, i.e. from heart to body and back to the heart.	Lymph flow is one way, i.e. from body tissues to the heart.
Blood travels at high speed.	Lymph travels at a very slow speed
Valves are only found in veins	Have valves in all its vessels
Contains blood cells and proteins	Only white blood cells present. Proteins are lacking
Does not contain emulsified fats	Contains and transports fatty acids and glycerol.
Have no nodes	Have nodes that produce lymphocytes

### **Similarities between blood system and lymphatic system**

1. Both have valves in their vessels.
2. Both are means of transporting materials in the body
3. In both a selected muscle provides a force by which substances are moved.
4. Both have vessels through which materials are transported.

## **BLOOD GROUPS**

There are 4 main blood groups i.e.

- 1) Blood group A
- 2) Blood group B
- 3) Blood group AB
- 4) Blood group O

When one has got less blood than necessary, blood transfusion is carried out. The one who gives blood to a patient is called a **donor** and the one receiving is known as a **recipient**. Doctors have to match the blood of the donor to that of the recipient because when incompatible blood is mixed, the red blood cells stick together (agglutinate) and blood clots. This is a fatal situation.

Agglutination is caused by the presence of proteins called **antigens** on the surface of cells being mixed with specific **antibodies**, which work against them. Blood groups are determined by the type of antigens one has in blood. This means that one having antigen A belongs to blood group A. Those with antigen B belong to blood group B. Those with antigens A and B belong to blood group AB while those without antigens belong to blood group O. Each blood produces particular antibodies, which work against particular antigens when introduced into the body. For example, blood group A produces antibody b. This means that blood group A is anti (against) blood containing antigen B (blood group B).

**The table below shows the blood groups, the antigens they carry and the antibodies they produce.**

Blood group	Antigen present	Antibody produced
A	A	b
B	B	a
AB	A and B	None
O	No antigen	a and b

**Note.**

Antibodies are represented by small letters while antigens are represented by capital letters.

Before doctors can carry out transfusion, they carry out tests to make sure that the patient's and donor's blood are compatible (the recipient's blood must not contain antibodies that act on the antigens in the donor's blood. For example antigen A would agglutinate if mixed with blood containing antibody a. i.e. blood group B.

**Table of compatibility:**

	Recipient			
	A	B	AB	O
Donor	A	√	X	√
	B	X	√	√

**Key**

X ----- Incompatible

AB	X	X	√	X
O	√	√	√	√

**Note.**

- 1) Blood group AB can receive blood from all other blood groups because it has no antibodies and it is therefore called a **universal recipient**.
- 2) Blood group O can donate blood to all blood groups because it has no antigens and it is therefore called a **universal donor**.

**“RHESUS FACTOR” System**

Rhesus factor is a protein (antigen) **ALSO** found on the cell membranes of the red blood cells.

Many individuals have the Rhesus factor and are said to be **rhesus positive (Rh<sup>+</sup>)** while a few do not have the Rhesus factor and are said to be **Rhesus negative (Rh<sup>-</sup>)**.

The Rhesus factor was first discovered in a **Rhesus Monkey** hence its name.

A person who is **Rhesus factor positive** can receive a successful blood donation without agglutination from a **person of Rhesus positive** and a **person of Rhesus negative**.

*However, a person who is Rhesus negative can only receive a successful blood donation without agglutination from his fellow Rhesus negative person though he can be transfused with blood which is Rhesus positive quite successfully only once and after this transfusion, his body produces antibodies against the Rhesus factor. Such antibodies attack the Rhesus factor with subsequent transfusion of Rhesus positive blood leading to agglutination.*

*The same concept can be applied to pregnancy in that a Rhesus positive woman can successfully carry on a pregnancy where the fetus is Rhesus positive or Rhesus negative.*

*A Rhesus negative woman can successfully carry a pregnancy where the fetus is only Rhesus negative; with such a woman, the first pregnancy with Rhesus positive fetus can be successful but during the pregnancy the woman’s blood produces antibodies against the Rhesus factor. Such antibodies attack the Rhesus factor if the woman gets subsequent pregnancies where the Fetus is Rhesus positive.*

**NB:** *During blood transfusion both the ABO system and the Rhesus factor system of blood groups are used together. So a person of blood group ARh<sup>+</sup> can receive blood from a donor of (i) A Rh<sup>+</sup> (ii) A Rh<sup>-</sup> (iii) ORh<sup>+</sup> (iv) ORh<sup>-</sup>*

Immunity is the ability of an organism to resist infection. The immune response is based upon recognition of a foreign particle and the release of chemicals that destroy it. The foreign particle may be an antigen, bacteria, virus or any other pathogen. The substance that destroys these particles can be a white blood cell or antibodies produced by white blood cells.

### **Types of immunity**

#### **Inborn or innate immunity**

This is the type of resistance to diseases that one is born with.

#### **Acquired immunity**

This is the type of immunity developed by the body during its life towards various diseases. It is divided into:

- Natural acquired immunity

- Artificial acquired immunity

#### **Natural acquired immunity**

This is the immunity provided by antibodies which are naturally acquired. It is further divided into 2 types:

- Natural active immunity

- Natural passive immunity

#### **Natural active immunity**

This is the type of immunity provided by antibodies produced by the body after being exposed to a particular disease. After production of the antibodies, the body becomes resistant to the subsequent similar infections e.g. contracting flu and recovering from it without using any drugs.

#### **Natural passive immunity**

This is the immunity provided by antibodies acquired from another individual of the same species. It is a temporary type of immunity e.g. the body obtains antibodies from the mother through breast feeding colostrum.

#### **Artificial acquired immunity**

This is the type of immunity provided by antibodies injected artificially from either the organisms of the same species or artificially made. It is divided into 2 types:

- Artificial active immunity

- Artificial passive immunity

#### **Artificial active immunity**

It is a product of inducing the body to produce antibodies by artificially injecting one with a vaccine (weakened/attenuated pathogenic organism). This process is called vaccination or immunization.

### **Artificial passive immunity**

This is the immunity provided by antibodies artificially injected into an individual. It is temporary and the body is not induced to produce its own antibodies.

## **GASEOUS EXCHANGE**

This is the exchange of respiratory gases between the organism and the environment. It takes place across specialized surfaces called respiratory surfaces. Gaseous exchange helps an organism to get rid of CO<sub>2</sub> produced during respiration within cells and at the same time obtain oxygen needed for aerobic respiration to occur.

**Note:** *Breathing is an **active process** involving movement of air in and out of the body whereas gaseous exchange is a **passive process** involving passage of air through respiratory surfaces/gaseous exchange surfaces.*

### **Characteristics of a good respiratory surface**

Respiratory surfaces are sites where gaseous exchange takes place in the body of the organism. Respiratory surfaces possess the following characteristics:

- 1) They have a large surface area to volume ratio to enable rapid diffusion of gases. This is achieved by folding or branching of structures to form alveoli in lungs, gill filaments in the gills and tracheoles in insects.
- 2) They are moist to allow easy diffusion of gases.
- 3) They are thin walled to reduce on the distance over which diffusion has to take place.
- 4) They have a good network of blood capillaries for easy transportation of gases to the respiring tissues.
- 5) They are well ventilated to maintain a high concentration gradient that favours diffusion of gases.

**Note;** respiratory surfaces of insects are not supplied with a network of blood capillaries because the blood of insects does not transport gases. The gases are transported in the tracheole tubes.

## **GASEOUS EXCHANGE IN PLANTS**

Plants do not have a special respiratory surface for gaseous exchange. They use simple pores i.e. stomata of the leaves and lenticels of the stems for gaseous exchange.

Gases circulate in the plant by simple process of diffusion due to abundant large intercellular spaces that make diffusion faster.

Plants do not need special respiratory surfaces and blood transport system because:

- ✚ They utilize  $\text{CO}_2$  produced by the plant cells for photosynthesis thus preventing accumulation.
- ✚ Plants produce oxygen as a bi-product of photosynthesis which is then used in respiration.
- ✚ Plants have numerous stomata and lenticels that favour fast gaseous exchange.
- ✚ They have large intercellular spaces that favour fast circulation of gases without blood.
- ✚ They have low demand for oxygen due to their low metabolic rate because they are less active since they are immobile.

### **Gaseous exchange in simple organisms**

Small organisms like amoeba, paramecium, hydra and jellyfish have a large surface area to volume ratio. In such organisms gaseous exchange takes place over the whole body surface. Because of their small body volume, diffusion alone is enough to transport oxygen and Carbon dioxide into, around and out of their bodies.

Larger organisms such as insects and vertebrates have a small surface area to volume ratio. In these organisms, gaseous exchange takes place in a specialized region of the body known as a respiratory surface. The respiratory surface is part of the respiratory organ. It is the actual site where gaseous exchange takes place.

### **Surface area to volume ratio and gaseous exchange**

Surface area to volume ratio is an important aspect in gaseous exchange. It is obtained by calculating the total surface area and dividing it by the volume of the object in question.

Consider two boxes A and B below

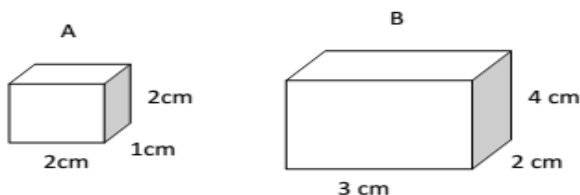

Box A is smaller than box B. we can work out the surface area to volume ratio of each box to prove that smaller objects have a larger surface area to volume ratio than big ones.

Starting with box A

Total surface area.

$$A = 2(2 \times 1) + 2(1 \times 2) + 2(2 \times 2)$$

$$A = 4 + 4 + 8$$

$$A = 16\text{cm}^2$$

Volume of A

$$V = L \times W \times H$$

$$V = 2 \times 1 \times 2$$

$$V = 4\text{ cm}^3$$

Surface area to volume ratio of A

$$\frac{16}{4}$$
$$= 4$$

Box B

Total surface area.

$$A = 2(3 \times 2) + 2(3 \times 4) + 2(2 \times 4)$$

$$A = 12 + 24 + 16$$

$$A = 52\text{cm}^2$$

Volume of B

$$V = L \times W \times H$$

$$V = 4 \times 2 \times 3$$

$$V = 24\text{ cm}^3$$

Surface area to volume ratio of B

$$\frac{52}{24}$$
$$= 2.3$$

The surface area to volume ratio of A is larger than that of B.

- ✚ Therefore the surface area to volume ratio of smaller organisms is larger than that of larger organisms. This facilitates a faster rate of diffusion to ensure that all body tissues are supplied with respiratory gases.
- ✚ Smaller organisms also have a short diffusion distance i.e. it takes less time for gases to move to all parts of their body. Most of them are single celled and some have only one layer of cells.

- ✚ Larger organisms on the other hand have a smaller surface area to volume ratio. This reduces the rate of diffusion and diffusion alone cannot meet the respiratory demands of their large bodies.
- ✚ They also have a large diffusion distance because they have very many layers of cells. Due to this large organisms have developed mechanisms, which reduce on the diffusion distance and increase the surface area to volume ratio.
- ✚ Mammals have developed a blood circulatory system, which transports blood containing respiratory gases through highly branched blood vessels to all cells of the body.
- ✚ Insects have developed a tracheal system, which has finely divided tubes known as tracheoles, which carry respiratory gases to and from all cells in the body of the insect.

### **Examples of respiratory surfaces and corresponding respiratory organs**

<b>Animal</b>	<b>Respiratory organ</b>	<b>Respiratory surface</b>
Amphibians	Lungs	Alveolus
Amphibians	Skin	Skin surface
Amphibians	Buccal cavity	Buccal cavity epithelium
Birds	Lungs	Alveolus
Fish	Gills	Gill filaments
Insects	Tracheal system	Tracheoles
Mammals	Lungs	Alveolus
Tadpoles	Gills	Gill filaments

**NB:** the movement of gases and water to and from respiratory surface is called ventilation (breathing).

### **GASEOUS EXCHANGE IN INSECTS**

The respiratory organs of insects consist of a network of tubes known as tracheal tubes, which make up the tracheal system. These tubes reach all the body tissues like the capillaries.

## The tracheal system of insects

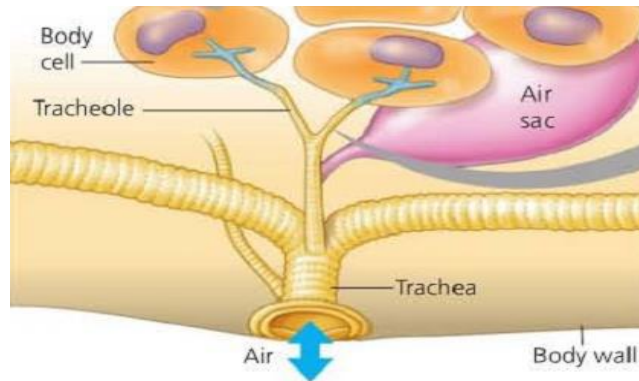

### Ventilation mechanism

#### Inhalation:

- ✚ When the abdominal wall expands, the internal pressure reduces and the volume increases.
- ✚ This forces air containing oxygen in to the insect through the spiracles, to the trachea and then the tracheoles.
- ✚ Between the tracheoles and muscles of the insect, gaseous exchange occurs with oxygen entering in to the tissues and CO<sub>2</sub> released from tissues, diffusing into the fluid in the tracheoles

#### Exhalation:

Abdominal wall contracts, internal volume decreases while pressure increases, forcing air with a high concentration of carbon dioxide in the tracheoles out of the insect through the spiracles.

## GASEOUS EXCHANGE IN FISH

Fish uses water as a medium of gaseous exchange and their respiratory surface is the internal gill.

Fish absorb dissolved oxygen from water by use of gills. In most fish there is a pair of gills on each side of the body and in bony fish the gills are covered by a gill plate also called the operculum.

### Structure of the gill

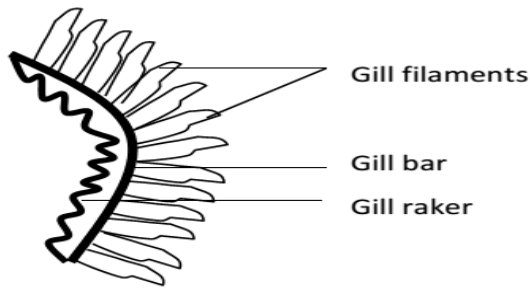

### Parts of the gill:

1. **Gill bar:** this provides an attachment and support to the gill filaments.
2. **Gill raker:** These are hard projections from the gill bar.
  - ✚ They trap food suspended in water.
  - ✚ They protect the gill filament by filtering out sand particles in water before reaching the gill filament.

### 3. Gill filaments:

These are sites of gaseous exchange in the fish.

- ✚ They are finger-like projections that increase the surface area for gaseous exchange.
- ✚ They have a network of capillaries whose blood moves in the opposite direction with water (counter current flow) to maintain a high concentration gradient by carrying away the diffused gases.
- ✚ Filaments have a thin membrane
- ✚ They are well ventilated.
- ✚ They are numerous to increase the surface area.

### Mechanism of ventilation in bony fish

Ventilation in bony fish occurs in two phases i.e. inhalation and exhalation.

#### Inward movement of water

- ✚ This is the process by which water containing dissolved oxygen is allowed into the body of the fish.
- ✚ The fish closes the operculum (gill cover) and opens the mouth.
- ✚ It then lowers the floor of the mouth cavity. This increases volume of the mouth cavity and lowers its pressure below that of the surrounding water.
- ✚ The mouth then opens to let in water into the mouth cavity (buccal cavity)
- ✚ Water flows into the mouth cavity through the mouth.
- ✚ It then closes the mouth and rises the buccal cavity to decrease the volume and increase the pressure in the buccal cavity.
- ✚ Meanwhile the gullet is closed.

- ✚ This makes the water current to flow into the gill chamber.
- ✚ As water passes over the gill filament, gaseous exchange takes place i.e. oxygen diffuses into blood while CO<sub>2</sub> diffuses from blood into the water.

### **Out ward movement of water:**

- ✚ For water to flow out after gaseous exchange, the operculum muscle relax then water flows out.
- ✚ Meanwhile the buccal floor is still raised and the mouth is still closed.
- ✚ The buccal floor then lowers to repeat the cycle.

## **GASEOUS EXCHANGE IN AMPHIBIANS**

### **a) Tad pole**

- ✚ Tad poles first use external gills and later internal gills as surface of gaseous exchange.
- ✚ The tad pole takes in water through the mouth and the water passes over the gills and then out of the body through the gill slit.
- ✚ The oxygen diffuses from the water into the blood while CO<sub>2</sub> diffuses from blood into water.

### **b) Adult amphibians**

In adults gaseous exchange takes place through the;

1. Skin.
2. Lining of the mouth cavity.
3. Lungs.

Amphibians depend mostly on their skin and buccal cavity for their gaseous exchange while they are in water. Lungs are only used when on land or when the water dries and the amphibian has to remain in mud.

#### **1. The skin**

The skin is thin walled, moist and has a good network of blood capillaries. The skin acts as a respiratory surface when the amphibian is in and out of water. It's used when the oxygen need is low.

On land, the atmospheric oxygen dissolves in the layer of moisture and then diffuses across the skin into the blood.

At the same time, CO<sub>2</sub> diffuses from the blood into the atmospheric air.

In water, the oxygen dissolved in it, diffuses from the water across the skin into blood. CO<sub>2</sub> diffuses from blood into water.

#### **2. The buccal cavity**

The buccal cavity has a thin lining which is kept moist. It also has a good network of blood capillaries. The cavity is ventilated in the following ways.

### **During inhalation:**

- ✚ The mouth floor lowers when it closes.
- ✚ This increases the volume of the buccal cavity reducing the pressure within.
- ✚ This forces the air from the atmosphere through the nostrils into the buccal cavity.
- ✚ Oxygen diffuses through the thin cavity membrane into blood while Carbon dioxide diffuses from blood into the buccal cavity.

### **During exhalation:**

- ✚ The muscles of the floor of the buccal cavity relax raising the floor of the mouth.
- ✚ This leads to a reduction in volume and an increase in pressure within the mouth cavity.
- ✚ Air then moves out to the atmosphere through the nostrils.

## **3. The lungs**

- ✚ The lungs consist of sacs supplied by a good network of blood capillaries.
- ✚ They have a large surface area.
- ✚ It is supplied with a lot of blood capillaries
- ✚ It is thin walled.
- ✚ Ventilation of the lungs occurs in the following stages;

### **Inspiration:**

- ✚ The mouth closes and the nostrils open.
- ✚ Muscles of the floor of the buccal cavity contract to lower the mouth floor. This increases the volume and reduces the pressure within the buccal cavity.
- ✚ Air enters through the nostrils into the buccal cavity.
- ✚ The nostrils close, the muscles of the floor of the buccal cavity relax to raise the floor of the buccal cavity, while those of the abdominal cavity contract.
- ✚ This causes the volume of the buccal cavity to reduce and that of the abdominal cavity to increase.
- ✚ Pressure in the buccal cavity increases and that in the lungs decreases.
- ✚ It opens the glottis and air moves from the mouth cavity into the lungs through the trachea.
- ✚ Oxygen diffuses from the lungs into blood and Carbon dioxide from the blood into the lungs.

## Exhalation:

- ✚ For exhalation, the abdominal muscles relax to reduce the volume of the lungs while the floor of the mouth cavity is lowered to increase its volume.
- ✚ This creates a higher pressure in the lungs and low pressure in the buccal cavity.
- ✚ Waste air is forced from the lungs into the buccal cavity
- ✚ The valve to the lungs (glottis) closes and nostrils open.
- ✚ Muscles of the floor of the mouth cavity relax raising the floor and increasing pressure in the buccal cavity.
- ✚ Waste air is forced from the cavity through the nostrils to the atmosphere.

## GASEOUS EXCHANGE IN BIRDS

Due to metabolic rate, birds need high supply of oxygen and an efficient gaseous exchange mechanism.

The respiratory system is made up of lungs and air sacs.

During inhalation, air enters through the trachea, bronchus and to the posterior air sac to the lungs, then to the anterior air sac and finally to the exterior (atmosphere) through the trachea.

### Illustration

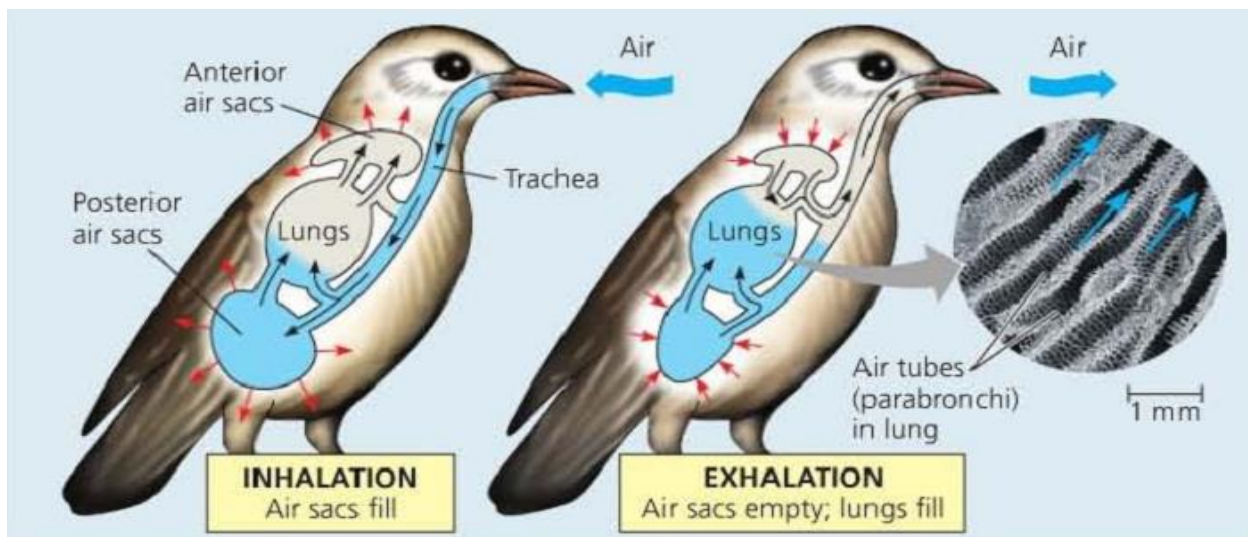

## GASEOUS EXCHANGE IN MAMMALS e.g. man

The respiratory organs in man are lungs and the respiratory surfaces are the sac like structures called alveoli.

### **The respiratory tract (air passage)**

Air enters through the nostrils into the nasal cavity where it is warmed to body temperature.

It begins from the nostrils into the back of the mouth, then into the pharynx from which it goes into the larynx and then to the trachea. From here, it travels through the bronchus, bronchioles and lastly to the alveolus.

The membrane of the nasal cavity is covered with cilia between which are goblet cells, which produce mucus.

Dust and germs inhaled from the atmosphere are trapped in mucus and are carried by the beating action of cilia towards the back of the mouth where they are swallowed.

This helps to prevent dust and germs from entering the lungs. Therefore, by the time air reaches the lungs it is dust and germ free, warm and moist. It is drawn from the nasal cavity into the trachea (wind pipe).

### **The trachea**

This is a tube running from the pharynx to the lungs. It is always kept open by the circular rings of cartilage within it. The cartilage prevents the trachea from collapsing in case there is no air.

Cilia and goblet cells extend into the trachea to draw germs and dust out of trachea into the mouth where they are lost.

At the lower end, the trachea divides into sub tubes called bronchi, which penetrate further into the lungs and divide repeatedly to form small tubes called bronchioles.

The bronchioles divide into many small tubes called alveolar ducts, which end in air sacs called alveoli.

The alveoli are the respiratory surfaces of mammals. There are about 300 million alveoli in a human lung. This increases the surface area over which gaseous exchange takes place.

### **Location of the lungs in the body**

They are located in the thoracic cavity, enclosed by thorax wall and diaphragm.

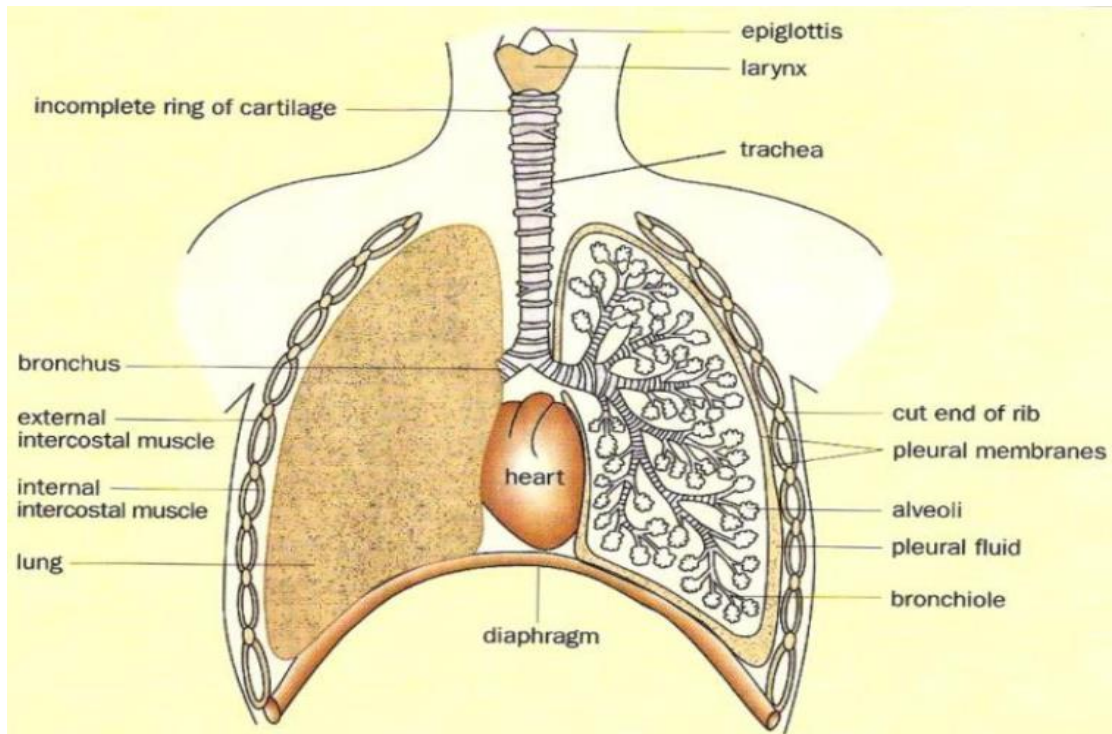

### **The alveoli**

An alveolus is a sac-like structure. The outer surface of the alveolus is covered with a network of blood capillaries. The alveolus is moist and thin walled. The oxygen in the alveolus diffuses into blood in the capillaries and it is carried around the body. At the same time, Carbon dioxide diffuses from blood into the alveolus and travels through the alveolar duct to the bronchioles then to the bronchi and trachea and out through the nostrils.

### **The mammalian lung**

These are two elastic spongy-like structures located within the thoracic cavity and protected by the rib cage. Between the ribs are intercostal muscles, which move the rib cage. Below the lungs is a muscular sheet of tissue called the diaphragm.

### **Breathing mechanism in mammals/ lung ventilation**

The breathing mechanism in mammals involves two sub-processes that are inspiration and expiration.

#### **Inspiration:**

This is the process by which air is allowed into the respiratory organs (lungs).

- ✚ The external intercostal muscles contract while the internal intercostal ones relax.

- ✚ This makes the rib cage to move outwards and upwards. The diaphragm contracts and flattens.
- ✚ This increases the volume of the thoracic cavity and reduces the pressure in it below that of the atmosphere.
- ✚ This causes air to enter from the atmosphere through the nostril, trachea, bronchi, and bronchioles until it reaches the alveoli.

### Expiration:

- ✚ The internal intercostal muscles contract and the external ones relax.
- ✚ This makes the rib cage to move downwards and inwards and the diaphragm becomes dome-shaped.
- ✚ This reduces the volume of the thoracic cavity and increases its pressure beyond that of the atmosphere.
- ✚ This forces the lungs to contract and release Carbon dioxide through the bronchi, trachea and out through the nostrils.

### Gaseous exchange in the alveolus

This take place across walls of alveoli and blood capillaries by diffusion.

During inspiration, air is taken into the lungs filling the alveoli. This air contains more oxygen and low CO<sub>2</sub> concentration. Oxygen in inspired air dissolves in the moisture of the alveolar epithelium and diffuses across this and capillary walls into the red blood cells of blood. Inside the red blood cell, oxygen combines with haemoglobin to form oxyhaemoglobin and carried in this form. At the same time, CO<sub>2</sub> which was carried as bicarbonate ion in blood diffuses from it through the capillary walls into the alveoli. It leaves the lungs in expired air.

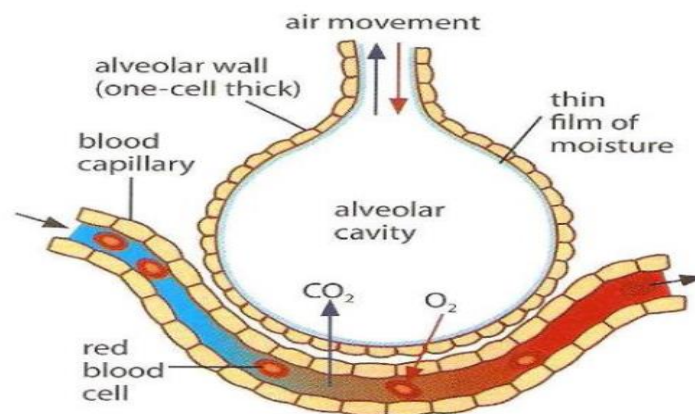

### Changes in the composition of gases in blood across the alveolus

#### Volume of gas carried by 100cc of blood

Gas	Entering lungs	Leaving lungs
Nitrogen	0.9cc	0.9cc
Oxygen	10.6cc	19.0cc
Carbon dioxide	58.0cc	50.0cc

The blood that flows towards the lungs contains a larger volume of carbon dioxide and less oxygen. But as it leaves the lungs, oxygen is added into it and some CO<sub>2</sub> is given off in the lungs. This indicates exchange of gases within the lungs.

### Changes in approximate air composition during breathing

Component	Inhaled	Exhaled
Nitrogen	79%	79%
Oxygen	21%	17%
Carbon dioxide	0.03%	4%
Water vapour	Less saturated (variable)	Saturated
Temperature	Atmospheric temperature	Body temperature

Although nitrogen is exchanged within the lungs and blood plasma, it plays no part in chemical reactions of the body hence its composition remains the same in inspired and expired air.

Inhaled air has more oxygen compared to exhaled air because it is taken up for the process of respiration, which produces out CO<sub>2</sub>. Hence exhaled air contains more CO<sub>2</sub> than inhaled air. However the process of gaseous exchange in alveoli does not remove all the carbon dioxide and oxygen in air.

### Experiment to demonstrate breathing in mammals

#### Materials

- ✚ Glass tubing,
- ✚ Cork,
- ✚ Rubber tubing,
- ✚ Y tube,
- ✚ Bell jar,
- ✚ Two balloons,
- ✚ Rubber sheet and
- ✚ Thread.

#### Procedure

- ✚ Get a bell jar and fix a cork with glass tubing in its mouth.

- ✚ Use a rubber tubing to connect a Y tube to the glass tubing inside the bell jar.
- ✚ Tie balloons on each end of the Y tube to act as lungs.
- ✚ Tie a rubber sheet using a rubber band at the open end of the bell jar to act as a diaphragm.
- ✚ Tie the end of a rubber sheet using a piece of thread.

### Note

The bell jar acts as the thoracic cavity and its walls as the rib cage. The glass tubing acts as the trachea and the ends of the Y tube act as the bronchi.

- ✚ Pull the end of the rubber sheet using the thread to represent inhalation and release it to represent exhalation.

### Setup

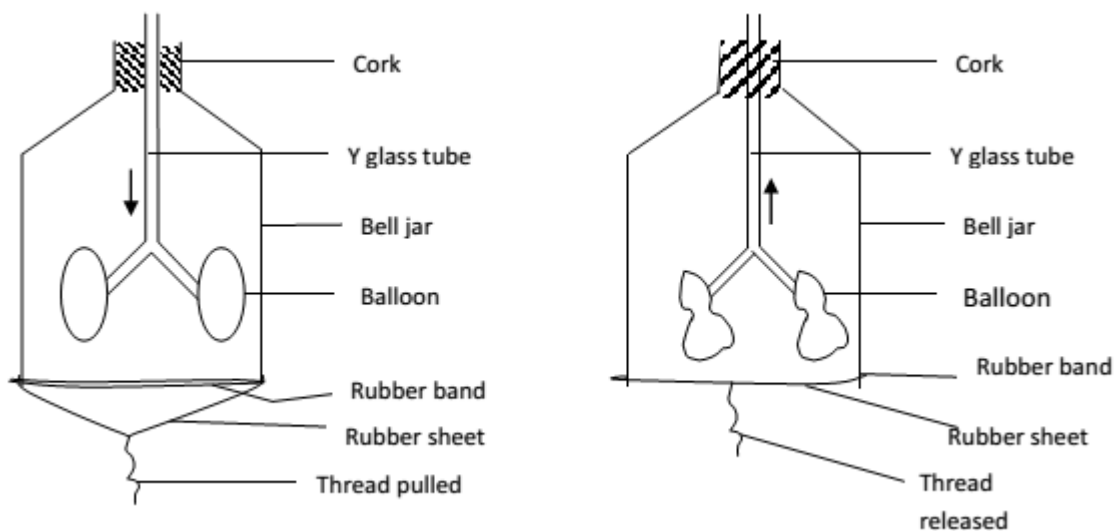

### Observation

- ✚ When the thread is pulled, the rubber sheet stretches. This increases the volume in the bell jar and reduces the pressure. Air enters from out through the glass tube to the Y tube and inflates the balloons.
- ✚ When the thread is released, the rubber sheet returns to its normal flat shape. This reduces the volume in the bell jar and increases the pressure. Air is forced out of the balloons through the Y tube and glass tubing. This deflates the balloons.

**Conclusion:** Pulling of the thread represents inspiration and its release represents expiration.

### Important terms related with breathing.

**Lung capacity:** This refers to the total volume of the lungs when fully inflated. In an adult man, this is about 5 liters. When breathing at rest only a small volume of

the lung is used. This is called the **tidal volume**. Tidal volume is the volume of air breathed in and out at rest. When the body is very active, a larger volume of air is taken into the lungs. This volume is called the **vital lung capacity**. However, even at maximum expiration some air remains inside the lungs to prevent the lungs from collapsing. This air makes up the **residual volume**.

### **Experiment to show that expired air contains Carbon dioxide.**

#### **Materials**

- ✚ Two test tubes,
- ✚ Two corks,
- ✚ T- Tube,
- ✚ Two right angled capillary tubes and
- ✚ Lime water

## Procedure

- Place the T tube in the mouth and breathe in and out normally.
- Air is made to pass into the lungs from test tube A and out through test tube B. inhalation air is got from the atmosphere through the capillary tube and lime water in tube A.
- Exhaled air passes through lime water and capillary tube at the B end.

## Set up of the experiment

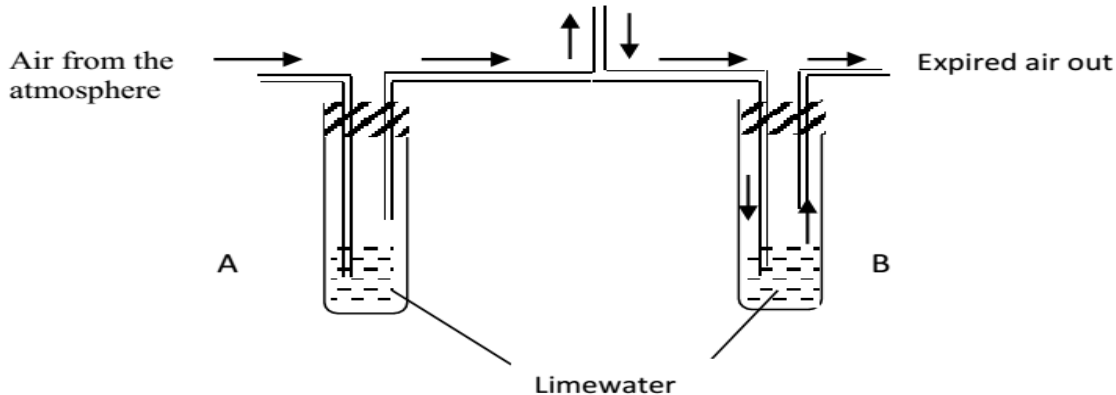

## Observation

Lime water in tube B turns milky while that in A remains clear.

## Conclusion

Expired air contains Carbon dioxide.

## Explanation

It is only Carbon dioxide, which can change the colourless limewater to milky. Therefore since B had expired air, it proves it.

## RESPIRATION AND GASEOUS EXCHANGE

### TISSUE RESPIRATION

This is the breakdown of food substances to release energy. It occurs with the help of enzymes. The major food respired (respiratory substrate) is a carbohydrate (glucose). All other compounds are converted into a carbohydrate before they are respired.

The energy released is stored as ATP (Adenosine tri phosphate).

ATP is highly energy rich compound formed between a chemical bond between ADP (Adenosine di phosphate) and inorganic phosphate groups, i.e.



If the energy stored as ATP is required by the body, ATP is suddenly broken down into ADP and  $\text{P}_i$  to release energy for the body activities i.e.

ATP  $\xrightarrow{\text{ATPase enzyme}}$  ADP + Pi + energy

**The energy released is used by the body for various activities i.e.**

- ✚ Maintaining blood circulation
- ✚ Bring about breathing movement
- ✚ For producing sound
- ✚ Transmission of nerve impulses from one part to another.
- ✚ Synthesis of blood proteins
- ✚ Maintaining the constant blood temperature
- ✚ Cell division either mitosis or meiosis leading to growth
- ✚ Active transport of materials into or outside the cell.
- ✚ Secretion of various materials like hormones, enzymes, etc.

### **Stages of respiration**

Respiration occurs in a series of reaction which are divided into 2 stages

#### **1. Glycolysis**

It involves breaking down of six carbon compounds (glucose) into 2 small 3 carbon compounds. This occurs in the cell cytoplasm.

#### **2. Krebs cycle**

It involves the breaking down of 3 carbon compounds further to release more energy than glycolysis. It occurs in the mitochondria.

**There are two types of respiration.**

1. Aerobic respiration.
2. Anaerobic respiration

### **AEROBIC RESPIRATION**

This is the breakdown of food to release energy in the presence of oxygen. This type of respiration produces energy, Carbon dioxide and water. This is the most efficient process by which energy is produced because there is complete breakdown of food and it therefore produces more energy.

**Equation for aerobic respiration**

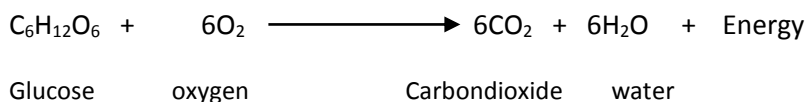

The Carbon dioxide produced diffuses from the tissues into the blood and it is transported to the lungs for expiration through the trachea and nostrils. In plants the Carbon dioxide produced is either lost to the atmosphere through stomata on leaves or lenticels in stems or used in photosynthesis to produce food.

## **EXPERIMENT TO DEMONSTRATE THAT LIVING ORGANISMS USE OXYGEN IN AEROBIC RESPIRATION**

### **Materials:**

Conical flask

Delivery tube

Beaker

Sodium hydroxide solution

Water

Germinating seeds

### **Procedure:**

- Some germinating seeds are placed in a conical flask in which a test tube containing sodium hydroxide is enclosed.
- A delivery tube is then connected to the conical flask with one end deeped in a beaker containing water.
- The setup is left to stand and observations are made on the level of water in the delivery tube.

### **Setup of the experiment**

### **Observation:**

After some time, water is seen to have risen in the delivery tube.

### **Conclusion:**

Oxygen is used in aerobic respiration.

### **Explanation:**

As the seeds respire, they use oxygen and produce  $\text{CO}_2$ . However, the  $\text{CO}_2$  is absorbed by the sodium hydroxide solution thus it's not added back to the air in the flask hence there's a decrease in the original volume of air in the flask.

## EXPERIMENT TO SHOW THAT LIVING ORGANISMS LIBERATE CO<sub>2</sub> DURING AEROBIC RESPIRATION

### Materials

- Soda lime (sodium hydroxide),
- Lime water,
- Filter pump,
- Toad ,
- Two delivery tubes,
- Three flasks and Corks.

### Procedure

- ✚ A rat is used as an aerobe and the experiment is fixed as shown below and left to stand for 40 minutes.
- ✚ The purpose of sodium hydroxide is to absorb CO<sub>2</sub> from the incoming air.
- ✚ Lime water in flask A is used to confirm the absence of CO<sub>2</sub> in the incoming air.
- ✚ Lime water in flask C is used to test for the presence of CO<sub>2</sub> in exhaled air.
- ✚ The filter pump ensures one direction of air.

### Setup

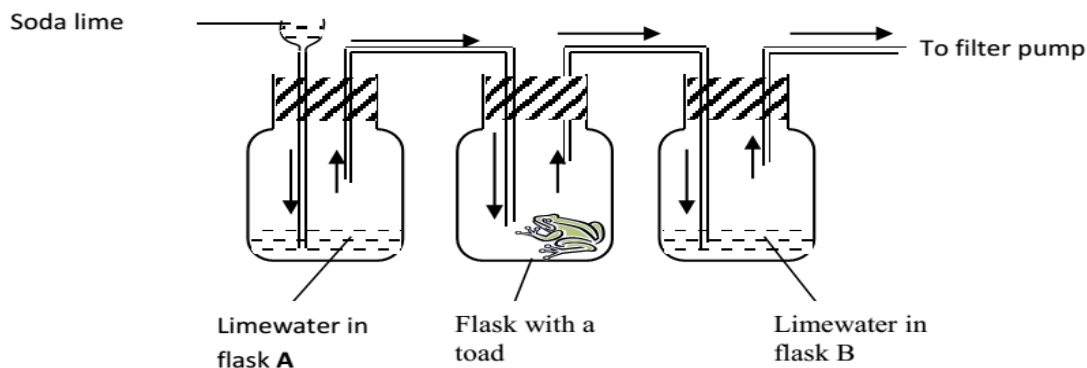

### Observation

Limewater in flask B turned milky while that in flask A remained clear.

### Conclusion

The living organism gives out Carbon dioxide during respiration.

## ANAEROBIC RESPIRATION

This is the breakdown of food to release energy in absence of oxygen.

In this process the food is not completely broken down but part of it remains in form of alcohol in plants and lactic acid in animals.

This process releases Carbon dioxide, energy and lactic acid in animals or ethanol in plants.

The incomplete break down of food results into less energy released from the same amount of food.

Most of the energy remains blocked in the intermediate substances (ethanol and lactic acid). When oxygen is provided lactic acid can be further broken down to release the remaining energy.

### Equation to show anaerobic respiration in plants

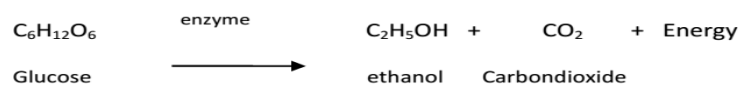

### OXYGEN DEBT

During vigorous activities the oxygen supply to muscles may not be enough to meet the energy demands of the organism. In the process the products of anaerobic respiration accumulate. As a result the rate of breathing of the individual increases even after an exercise to provide extra oxygen required to oxidise the accumulated lactic acid to  $\text{CO}_2$ , water and energy.

In this condition the organism is said to be in an oxygen debt. **Oxygen debt** therefore is the amount of oxygen needed to break down the accumulated lactic acid in muscles after vigorous exercises.

### Equation for anaerobic respiration in animals

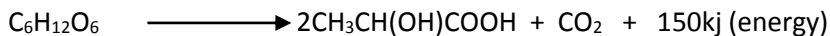

### Graph showing change in lactic acid and concentration during and after exercise

Lactic acid increases rapidly during an exercise till the end. This is due to increased rate of anaerobic respiration due to lack of enough oxygen supply.

At the end of the exercise, lactic acid content in muscles drops suddenly because it is being oxidized to CO<sub>2</sub>, water and more energy in the liver. The oxygen used in breaking down this lactic acid is attained by breathing deeply.

### **Anaerobic respiration in plants**

When plants respire without oxygen, glucose is broken down into ethanol, CO<sub>2</sub>, water and energy.



Glucose                      ethanol              Carbon dioxide

Little energy is produced, much of it still locked in the partially broken ethanol.

### **Anaerobic respiration in yeast**

- The form of anaerobic respiration carried out by yeast is known as fermentation.
- Fermentation is any form of anaerobic respiration in solution form.
- In yeast, fermentation leads to production of ethanol, CO<sub>2</sub> and energy which is a chief product. The enzyme which is involved is zymase.



Glucose                      ethanol              Carbondioxide

### **Application of anaerobic respiration**

- ✚ The process is commercially exploited in beer brewing to produce alcohol
- ✚ It is also used in baking of bread to raise dough.

### **Experiment to show that CO<sub>2</sub> is given off during anaerobic respiration/fermentation**

#### **Materials:**

- ✚ Two test tubes,
- ✚ Delivery tubes,
- ✚ Yeast,

- ✚ Glucose,
- ✚ Oil and
- ✚ Lime water.

#### **Procedure**

1. Boil about 20 cm<sup>3</sup> of glucose solution *to drive off oxygen* from it and allow it to cool to room temperature.

2. Add a layer of oil over glucose solution to prevent oxygen from dissolving in it.
3. Add a small quantity of yeast suspension to the glucose solution using a pipette.
4. Pour limewater in one test tube.
5. Using a delivery tube and rubber bands fix the delivery tube in the test tube as shown below.
6. Leave the experiment to stand in a warm place for an hour.

### Setup

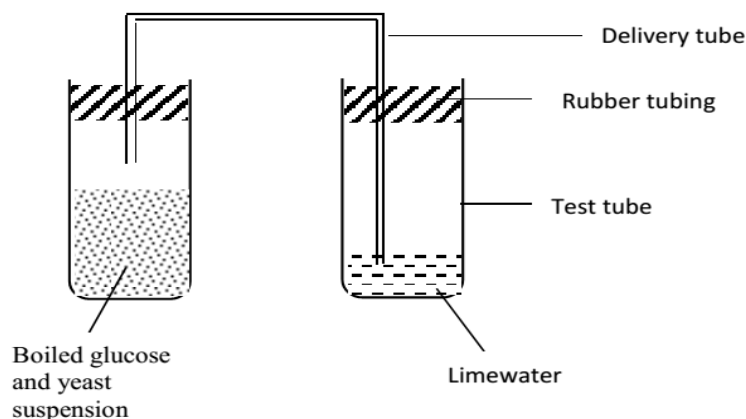

*Set up a control experiment in the same way but using a boiled yeast suspension or without yeast or without glucose.*

### Observation

Bubbles of a gas are seen in limewater and limewater turns milky.

### Conclusion

Carbon dioxide is produced during anaerobic respiration.

### Explanation

Yeast breaks down glucose in absence of oxygen to produce ethanol, CO<sub>2</sub> and some heat.

The CO<sub>2</sub> produced turns lime water milky by reacting with calcium hydroxide to form insoluble calcium carbonate.

### Experiment to demonstrate the liberation of heat during fermentation of yeast

OR

## **Experiment to show the production of energy in absence of oxygen (anaerobic respiration)**

### **Materials:**

- ✚ 10% glucose solution
- ✚ 10% yeast suspension
- ✚ 2 vacuum/thermos flasks
- ✚ 2 thermometers
- ✚ Cooking oil
- ✚ Water bath
- ✚ Cotton wool

**Procedure:**

100cc of glucose solution is boiled in a beaker over a water bath so as to drive out any dissolved oxygen and then allowed to cool.

50cc of glucose solution is each poured in each flask and small quantities of oil are added to prevent entry of oxygen into the glucose solution.

Yeast solution is added below the oil layer of one of the flasks using a dropper/pipette.

A thermometer is placed in each flask and kept in solution with cotton wool as shown below.

The thermometer readings are recorded hourly at intervals for some time.

**Observation:**

After some time, the temperature rises in flask A steadily while in B, the temperature remains the same.

**Conclusion:**

The temperature rises in flask A due to anaerobic respiration of glucose by producing heat.

In B, there's no yeast to respire anaerobically hence no heat is produced.

**Experiment to show that energy (heat) is released by germinating seeds during respiration****Materials:**

- ✚ Vacuum flask,
- ✚ Germinating seeds,
- ✚ Cotton wool and

- ✚ Thermometer.
- ✚ Sodium hypochlorite solution

## Procedure

- ✚ The seeds are soaked in water for 24 hours.
- ✚ One group of seeds is then killed by boiling them in water.
- ✚ Both sets of seeds are soaked in formalin for 15 minutes in order to kill any bacterial and fungal spores.
- ✚ Place moist germinating seeds in one flask.
- ✚ Place the boiled seeds in another flask.
- ✚ Insert a thermometer in each of the flasks plugged with cotton wool.
- ✚ Fix the two flasks on a retort stand in an upside down position so that the seeds are near the thermometer bulb as shown below.

## Setup

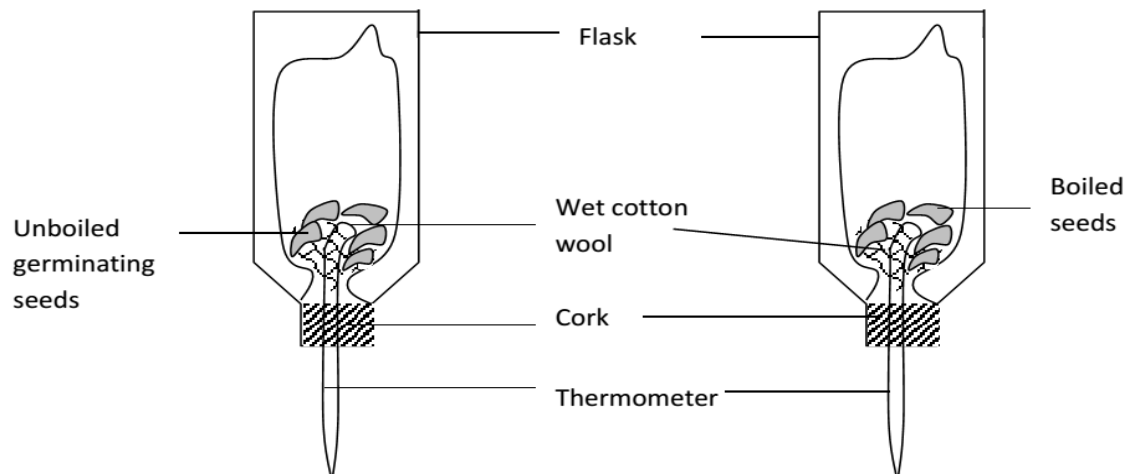

## Observation

After three days the temperature in the germinating seeds is higher than that of the boiled seeds. That of the boiled seeds remains constant.

## Conclusion

Germinating seeds give out heat.

## Explanation

During germination oxygen is absorbed to carry out respiration, which gives out energy in form of heat.

## Similarities between aerobic and anaerobic respiration

- 1) Both require glucose as a raw material.
- 2) Both produce energy.
- 3) Both produce Carbon dioxide.
- 4) Both take place in living cells.

### **Differences between aerobic and anaerobic respiration**

<b>Aerobic respiration</b>	<b>Anaerobic respiration</b>
A common mode of respiration in both plants and animals	Rare process limited to few plants and animals
Produces more Carbon dioxide	Produces less Carbon dioxide.
Occurs throughout life	Occurs temporary in very active muscles
Liberates large quantities of energy	Liberates less energy
Products are water, Carbon dioxide and energy	Products are Carbon dioxide, energy and alcohol or lactic acid.
Complete breakdown of food	Incomplete break down of food.
Oxygen is used	Oxygen is not used.

**Respiration quotient:** This is the ratio of CO<sub>2</sub> produced to oxygen used:

$$RQ = \frac{\text{CO}_2 \text{ produced}}{\text{O}_2 \text{ used}}$$

### **Importance of respiration**

- 1) Respiration produces energy that is used to run the various activities in the body.
- 2) It is exploited commercially in baking, brewing and making of dairy products such as cheese, yoghurt and butter.

### **Similarities between respiration and photosynthesis**

- 1) Both take place in living cells.
- 2) Both involve enzymes.
- 3) Both involve oxygen, Carbon dioxide and glucose.
- 4) Both involve energy.

### **Differences between respiration and photosynthesis**

<b>Respiration</b>	<b>Photosynthesis</b>
Oxygen is absorbed	Oxygen is released
Carbondioxide is released	Carbondioxide is absorbed
Takes place in light and darkness	Needs light to take place
Energy is released	Energy is absorbed
Does not require chlorophyll	It requires chlorophyll
Take place in plants and animals	Takes place in plants only.

## **EXCRETION AND OSMOREGULATION**

Excretion is the removal of waste products of metabolism from the body. Most of the waste products are toxic when allowed to accumulate in the body.

### **Importance of excretion**

- ❖ To remove toxic waste products whose accumulation in the body poisons/harms the organisms
- ❖ To remove excess materials in the body which when left to accumulate affects the body metabolism.

**Excretory products are divided into two groups:**

#### **1. Nitrogenous excretory products.**

These are excretory products, which contain the element nitrogen. They include ammonia, urea and uric acid.

**Ammonia:**

This is a highly toxic nitrogenous waste and it requires a lot of water for its elimination. It is very soluble in water and due to this it requires less energy to be excreted. Ammonia is excreted by organisms which live in fresh water and therefore have a lot of water in their bodies. Such organisms include bony fish, protozoans, and amphibians when in water,

**Urea:**

This is a less toxic nitrogenous waste. It requires less water for its excretion. It however requires a lot of energy for its excretion because of its low solubility in water compared to ammonia. Urea is excreted by terrestrial organisms, which have easy access to water, and marine organisms. Such organisms include terrestrial mammals, amphibians when on land, cartilaginous fish, etc.

**Uric acid:**

This is less toxic than urea and requires no water for its elimination from the body. It is insoluble in water. The demerit of excreting uric acid is that it requires a lot of energy for its excretion. Uric acid is excreted by birds, reptiles and insects and also common in desert animals.

**2. Non nitrogenous excretory products.**

These are excretory substances that do not contain the element nitrogen. Such products include Carbondioxide, excess salts and excess water.

**A table showing examples of organisms, their excretory products, their excretory organs and their habitats**

<b>Example of organism</b>	<b>Excretory product</b>	<b>Excretory organ</b>	<b>Habitat</b>
Bony fish	Ammonia	Kidney	Fresh water
Cartilaginous fish	Urea	Kidney	Marine water
Reptiles	Uric acid	Kidney	Terrestrial

Birds	Uric acid	Kidney	Terrestrial
Tadpoles	Ammonia	Gills	Fresh water
Adult amphibians	Ammonia	Kidney	Fresh water
	Urea		Terrestrial
Mammals	Urea	Kidney	Terrestrial
Insects	Uric acid	Malpighian tubules	Terrestrial

Animals producing nitrogenous compounds in form of urea are those living on land but have easy access to water. This is because though urea is less toxic than ammonia, it needs a relatively high amount of water to reduce its toxicity to the body during excretion. Urea is excreted in form of urine, which is a mixture of urea, salts and water. Urea is excreted by mammals, amphibians when on land and marine vertebrates.

Animals producing nitrogenous wastes in form of uric acid are those living on land with little access to water. Uric acid is the least toxic and needs the least amount of water for its excretion. Such animals conserve their water because it is not lost during excretion. These animals include, bird, reptiles and insects.

### Excretory organs

These are organs that release excretory products. They include the following.

**Table showing excretory organs and their corresponding excretory products**

Excretory organ	Excretory product
Lungs	Carbondioxide and water
Liver	Bile pigments
Kidney	Urea, excess salts and excess water
Malpighian tubules	Uric acid
Skin	Excess water, excess salts and some urea

### EXCRETION IN MAN

In man the excretory organs are the kidneys, skin and lungs. Their excretory waste products are as shown in the table below.

Excretory organ	Excretory product	Excretory substance
Skin	Sweat	Urea, excess salts and excess water

Lungs	Exhaled air	Carbondioxide and water
Kidney	Urine	Urea, excess salts and excess water.

## THE KIDNEY AND THE EXCRETORY SYSTEM

### Structure of urinary system

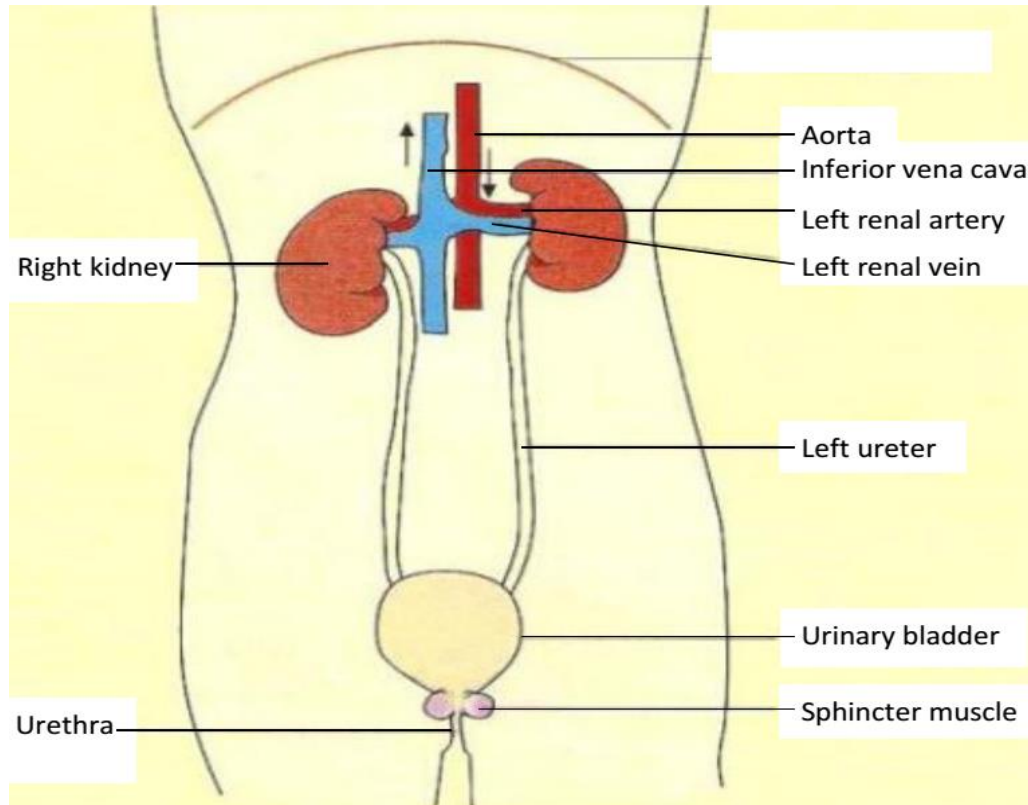

### Parts and functions of the urinary system

**1) Aorta**

It carries oxygenated blood with all food nutrients to the kidney.

**2) Renal artery:**

This arises from dorsal aorta. It brings blood containing excretory products to the kidney.

**3) Renal vein:**

It carries filtered blood from the kidney to the posterior vena cava.

**4) Ureter:**

These are two narrow tubes arising from hilum of each kidney. They connect the kidneys to the urinary bladder. They transport urine to the urinary bladder.

**5) Urinary bladder:**

It is a thick walled elastic sac-like structure which stores urine.

**6) Sphincter muscle:**

These muscles are elastic thus can contract and relax to control urine flow.

## 7) Urethra:

It is a passage for urine to the outside of the body.

## THE KIDNEY

### Structure of the kidney

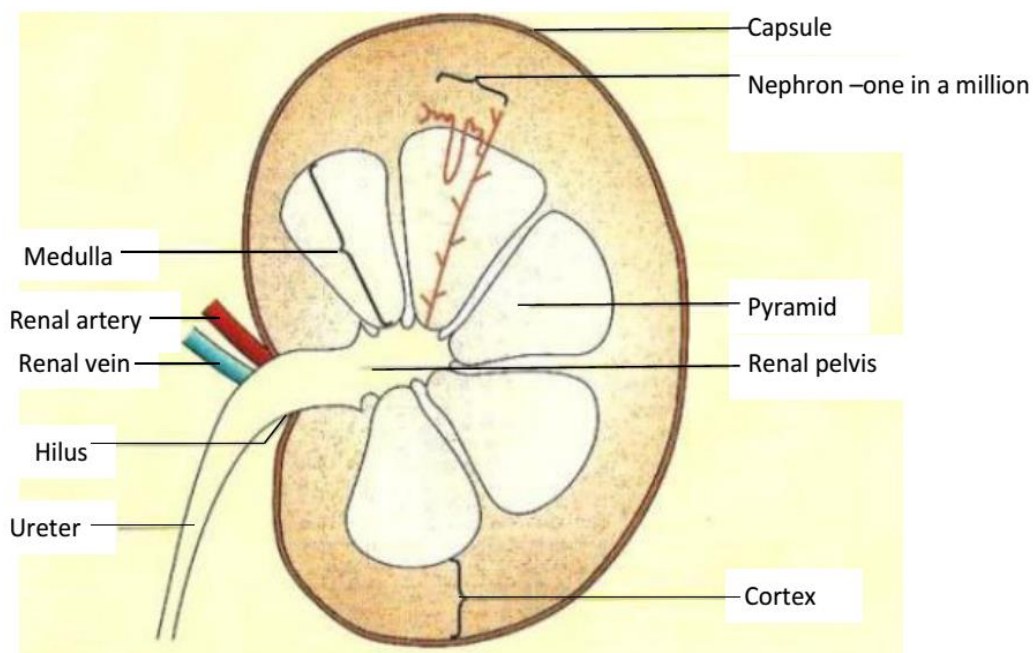

The kidneys are solid bean-shaped structures and they occur in pairs in mammals. They are reddish-brown in colour enclosed in a transparent membrane and attached to the back of the abdominal cavity.

The kidney tissue consists of many capillaries and renal tubules connected together by connective tissue. The kidney has two major parts.

1. The **cortex** which is a dark outer part. It consists of the Bowman's capsule which is responsible for ultra-filtration of blood passing across it.
2. The **medulla**, which is a lighter inner, part. It is made up of many cone-shaped portions called pyramids.

The pelvis is the area where the ureter leaves the kidney.

### *The kidney performs three major functions in the body.*

1. It carries out excretion.
2. It carries out the function of osmoregulation.
3. It contains endocrine glands, which secrete hormones.

The kidney is made up of several microscopic structures (functional units) called nephrons where the actual excretion and osmoregulation takes place.

### **THE NEPHRONE**

This is the functional unit of the kidney. It carries out the function of excretion and osmoregulation in the kidney.

The nephron consists of a cup-shaped structure known as the *bowmans' capsule*. Blood comes to the nephron through the *afferent vessel*, which is a branch of the renal artery, and it leaves through the *efferent vessel*.

The efferent vessel joins many other efferent vessels from other nephrons to form the *renal vein*.

In the bowmans' capsule the afferent vessel divides to form capillaries.

The capillaries are highly coiled and they form a knot called *glomerulus*.

Leading from the bowman's capsule is a highly coiled tube known as *proximal convoluted tubule*. This is continuous with a U shaped tubule called *loop on Henle*.

The loop is divided into the descending loop and ascending loop.

From the loop of Henle the tube becomes highly coiled to form the *distal convoluted tubule* which leads to the *collecting duct*.

### **Structure of the nephron**

## Parts of nephron

### 1. Bowman's capsule:

It contains a dense-network of capillaries called **glomerulus**. The glomerulus is formed from the wider arteriole of renal artery called afferent arteriole. It is located in the cortex.

The Bowman's capsule serves the function of filtering small molecules in blood such as urea glucose, etc. through a process called ultra-filtration.

### Adaptations of the glomerulus to ultra-filtration

- i) Having high blood pressure that forces small molecules out of the glomerulus. This is due to the afferent arteriole being wider than the efferent.
- ii) Having many capillaries that give it a large surface area for ultra-filtration.
- iii) Having a semi permeable membrane that can allow any small molecule to pass through.

### Adaptations of the Bowman's capsule to collect the filtrate

- i) Possession of cup-shaped structure which enables it to collect the filtrate.
- ii) Having a porous upper membrane that easily allows filtration.
- iii) Having a large volume that can accommodate more filtrate.

### 2. Proximal convoluted tubule:

This is a site where re-absorption of useful materials such as glucose and some small amino acids and water from glomerular filtrate back to blood takes place.

### 3. Loop of Henle:

It's made up of a descending (going down) limb and an ascending (going up) limb. *The main function of the loop of Henle is to make the tissue fluid in the medulla more concentrated than the glomerular filtrate in the nephron so that water needed in the body is reabsorbed. It's known to cause the retention of water. This is one way of conserving water in camel because of its extremely long loop of Henle.*

### 4. Distal convoluted tubule:

It chiefly re-absorbs salts like chloride ions together with water, leaving a concentrated liquid now called urine which passes down to collecting ducts.

### 5. Collecting duct:

This duct carries urine from the distal tubule to the pelvis of kidney. It allows outward movement of water thus conserving it.

### **Adaptations of the nephron to re absorption**

- i) Having a thin membrane (one cell thick) for easy diffusion of materials.
- ii) Having micro villi to increase the surface area for re absorption.
- iii) Having numerous mitochondria to provide energy for active reabsorption.

### **URINE FORMATION**

The process of urine formation takes place in the nephron. It occurs in two phases.

1. Ultra-filtration.
2. Selective re-absorption.

#### **Ultra filtration**

- ✓ Much blood comes from the **afferent vessel** into the glomerulus than that which leaves through **efferent** because the afferent vessel is larger than the efferent vessel.
- ✓ This generates pressure in the blood capillaries of the glomerulus forcing small molecules to filter out of the blood capillaries to form the glomerular filtrate.
- ✓ Blood in the renal artery contains proteins, red blood cells, white blood cells, urea, water, salts, amino acids and vitamins.
- ✓ In the glomerulus, small molecules filter out by *ultra filtration* to form the glomerular filtrate. *This filtrate contains glucose, urea, water, salts and vitamins.*
- ✓ *Proteins and blood cells do not filter out* because they have bigger molecules, which cannot pass through the walls of the glomerulus.
- ✓ The filtrate formed moves from the Bowman's capsule through the capsular space to **proximal convoluted tubule** where selective reabsorption starts to occur.

#### **Diagrammatic illustration of ultrafiltration**

Blood leaving the glomerulus contains proteins and blood cells because they have bigger molecules, which cannot pass through the walls of the glomerulus.

Blood entering through the afferent vessel contains proteins, red blood cells, white blood cells, urea, water, salts, amino acids and vitamins.

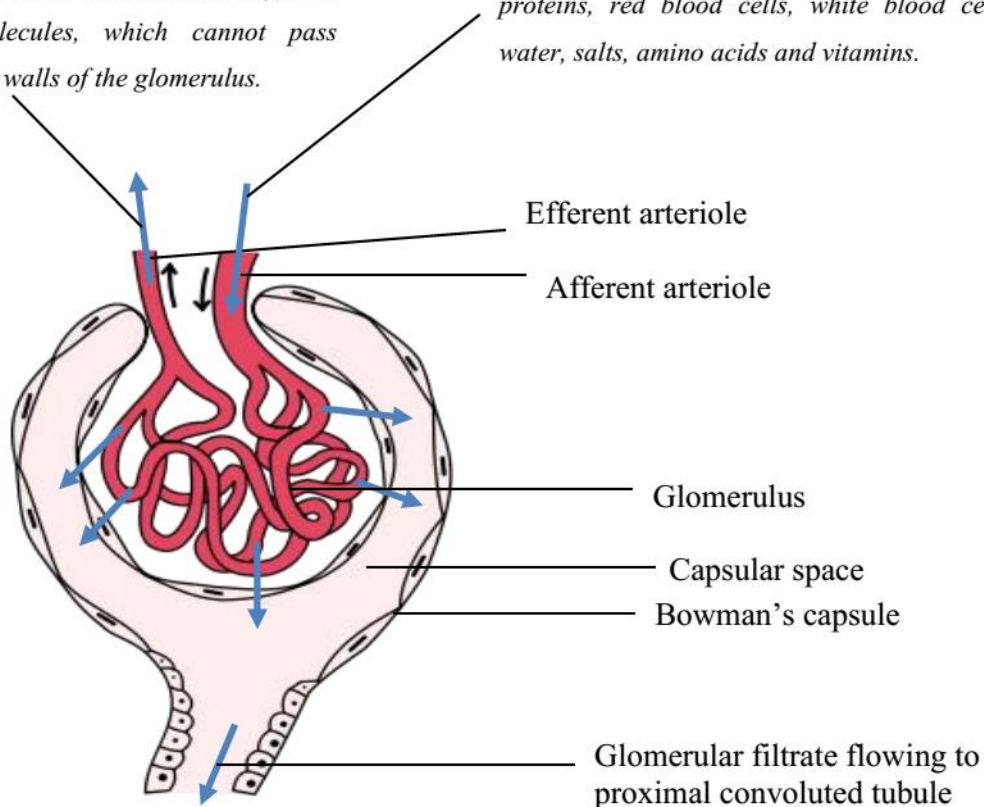

### Selective reabsorption

#### ***In the proximal convoluted tubule:***

- ✓ Most of the food materials are re absorbed into the blood capillaries by active transport e.g. all the glucose, vitamins, some salts like sodium chloride and even some water is re absorbed by diffusion.

#### ***In the loop of Henle:***

- ✓ As the filtrate flows down the descending limb, water is re absorbed back into the capillaries by osmosis leading to increased concentration of the filtrate down the descending limb.
- ✓ As the filtrate ascends, the thick ascending limb of loop of Henle, salts like Na and K are reabsorbed by active transport. This leads to a decrease in concentration of the glomerular filtrate in the ascending limb.

#### ***In the distal convoluted tubule:***

- ✓ Selective re absorption of salts by diffusion occurs.

#### ***In the collecting duct:***

- ✓ Water is lost to the highly concentrated medulla tissues by osmosis from which later the remaining filtrate is **urine** which goes via the ureter and temporarily stored in the urinary bladder.

### Summary of the steps involved in formation of urine in the kidneys

Name	Process	Examples of molecules
Ultra-filtration (pressure filtration)	High blood pressure forces small molecules from the glomerulus into Bowman's capsule.	Water, glucose, amino acids, salts, urea, uric acid, creatinine.
Selective reabsorption	Diffusion and active transport return molecules to blood at the proximal convoluted tubule.	Glucose, water, salts and amino acids.
Tubular secretion	Active transport moves molecules from blood into the distal convoluted tubules.	Uric acid, creatinine, ammonia and hydrogen ions.
Reabsorption	Along the length of the nephron and notably at the loop of Henle and collecting duct, water returns by osmosis following active reabsorption of salts.	Water and salts.
Excretion	Urine formation rids body of metabolic wastes	Water, salts, urea, uric acid, ammonia.

### Comparison of substances in blood and urine

Nitrogenous waste	In blood	In urine
Urea	0.03	2.0
Proteins	7-9	0
Glucose	0.1	0
Chloride ions	0.37	0.6
Sodium ions	0.32	0.35
Water	93	95

- ✓ There are proteins in blood and there is none in urine because proteins are not filtered out of the blood vessels into the glomerulus due to the large size of their molecules.
- ✓ Urea is more in urine than in blood because it is filtered out of blood and it is not reabsorbed back in the blood.
- ✓ Water is more in urine than in blood because it is used to dissolve urea.
- ✓ However the relative amounts of water in urine and in blood varies depending on the amount of water in the body, amount of solutes in the body, temperature and body activity.

- ✓ There is glucose in blood and no glucose in urine because glucose is reabsorbed from the glomerular filtrate back into the blood.
- ✓ Salts like chlorides and sodium ions are more in urine than in blood. This is because they are in excess and they are not reabsorbed back into the blood. Because of this they tend to concentrate in urine.

### **EXCRETION IN PLANTS**

Plants excrete less poisonous waste products like CO<sub>2</sub> through the stomata and acids through dropping leaves and fruits. Plants do not require specialized excretory organs due to;

- i) Plants can store excess proteins unlike in mammals.
- ii) They accumulate less metabolic wastes due to their low metabolic rate.
- iii) Plants synthesize their organic food substances according to their requirements. This ensures that no excess is made.
- iv) Plants do not produce nitrogenous waste products. They produce non-nitrogenous wastes, which are less toxic to their bodies.
- v) Some wastes accumulate in particular parts of the plant and they are eliminated when this part of the plant falls off.
- vi) Some of the wastes are useful in other processes within the plants body. For example Carbon dioxide produced from respiration can be used in photosynthesis.
- vii) They do not locomote and they are less metabolically active than animals.

### **HOMEOSTASIS**

This is the maintenance of a constant internal environment of the body. The internal environment of the body is composed of tissue fluids, which surround cells. Homeostasis involves controlling the blood sugar level, salt level, water level, temperature and Carbon dioxide concentration.

### **WATER BALANCE AND OSMOREGULATION IN MAN**

It is the maintenance of blood concentration constant.

This is the control of the amount of water in the body.

The water level is kept neither high nor low but within a limit according to the demands of the body.

The level is maintained by loss of excess and gain if more is required.

Water is lost from the body through urine, sweat, expiration, and feces during egestion and it can be gained through; drinking eating and water from metabolism.

The loss and gain of water brings about changes in blood concentration.

These changes are detected in the brain by the hypothalamus. If the blood passing through the brain is too concentrated, the hypothalamus stimulates the anterior lobe of the pituitary gland to secrete a hormone called *antidiuretic hormone (ADH)* into the blood stream. When the hormone reaches the kidneys, it causes the walls of the nephrones (distal convoluted tubules and collecting ducts) *to become permeable to water* and water is reabsorbed from the glomerular filtrate back into the blood. The urine that is secreted becomes more concentrated and yellowish in colour. This reduces the loss of water in urine.

If blood passing through the hypothalamus is too dilute, the production of ADH from the pituitary gland stops and the nephrones become less permeable to water. Less water is therefore reabsorbed from the glomerular filtrate resulting into production of colourless urine in big volumes. This mostly happens during cold conditions where water loss through sweating is minimal.

When conditions are hot, sweating increases, lowering the water level in blood. This causes more re-absorption of water in the nephrones resulting in production of concentrated pale yellow urine.

*Because of the high concentration, when urine is poured on grass or any plant, they get scotched because the cells lose water to the surrounding concentrated urine and the plant cells become flaccid. This brings about wilting and drying of the plant.*

When the level of water in blood is too low the hormone causes a feeling of thirst, which makes one to drink water in order to bring back the normal water level in blood.

Failure of organisms to secrete ADH leads to constant urination of large amounts of dilute urine thus increases the blood concentration, a condition known as *diabetes inspidus*.

## **EXCRETION AND OSMOREGULATION IN OTHER ANIMALS**

### **THE AMOEBIA**

Amoeba excretes excess water by use of a contractile vacuole. The contractile vacuole is a small sac-like structure lying inside the cytoplasm.

The cell membrane surrounding amoeba is semi-permeable and since the concentration of the cytoplasm is higher than that in the environment surrounding amoeba, water molecules move by osmosis from out into the cytoplasm of amoeba. The organism uses some of the water and excess is secreted into the contractile vacuole, which is formed in the process. As the

vacuole enlarges, it moves towards the cell membrane and finally fuses with it. It then bursts to release the excess water out. A new vacuole is formed when the organism is excreting more water.

### Illustration

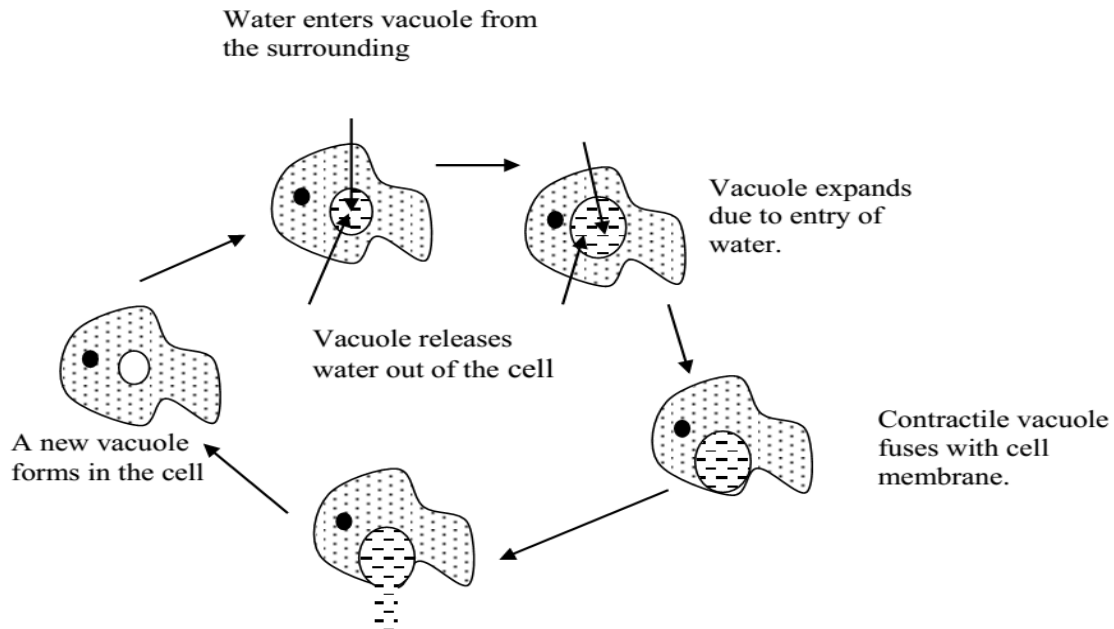

### INSECTS

Excretion in insects is carried out by structures called Malpighian tubules, which are found between the mid gut and the rectum of the insect's alimentally canal.

Insect tissues produce nitrogenous wastes in form of potassium urate, which is liberated into the blood stream and taken to the malpighian tubules. In the tubules, urate reacts with Carbondioxide and water to form uric acid, which is released out of the body along with faeces.

**Diagram showing the position of the malpighian tubules**

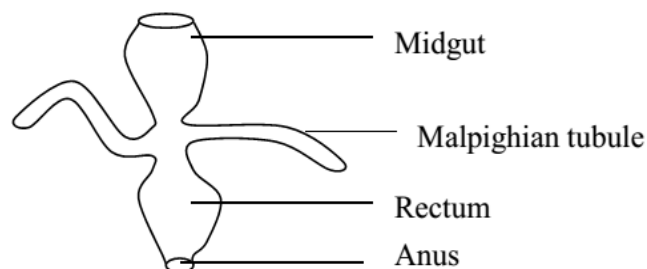

## CONTROL OF SALT LEVELS IN BLOOD

If the salt levels are high in blood, the blood concentration increases, this is detected by the hypothalamus as blood flows through it. It then instructs the pituitary gland which then instructs the adrenal gland to stop the production of *aldosterone* thus little or no salts get reabsorbed back into the blood within the nephrons.

If the salt levels are low in blood, the pituitary gland instructs the adrenal gland to release *aldosterone* hormone which increases salt re absorption during urine formation leading to dilute urine.

## HOMEOSTATIC CONTROL OF BLOOD SUGAR IN HUMANS

Blood sugar is called glucose. Its concentration is controlled by a section of the pancreas called islets of Langerhans. This gland regulates responding organs mainly the liver and muscles through its secretions.

### Importance of blood sugar regulation

1. It prevents cells running short of glucose in case its level drops. Blood sugar (glucose) is the main source of energy.
2. Any slight increase in glucose level alters the concentration of blood's osmotic pressure, which results in alteration of the rate at which water moves in and out of the body cells by osmosis.

Blood glucose concentration is controlled by the pancreas. The pancreas has glucose receptor cells which monitor the concentration of glucose in the blood, and it also has *endocrine cells* (called *the islets of Langerhans*), which secrete two hormones. The alpha cells ( $\alpha$  cells) secrete a hormone called *glucagon*, while the beta cells ( $\beta$  cells) secrete a hormone called *insulin*. These two hormones are antagonistic, and have opposite effects on blood glucose.

### Mechanism of blood sugar regulation

After a meal of carbohydrates, glucose is absorbed from the gut into the *hepatic portal vein*, increasing the blood glucose concentration. This is detected by the pancreas, which secretes insulin from its beta cells in response.

### Insulin causes glucose;

- To be taken up by the liver and converted to glycogen and stored there.
- To be converted into fats. Fats are stored in adipose tissue.

- To be broken down to release energy at higher rate. This energy is stored in a form of high energy compound called ATP. This reduces blood glucose in excess.

Once the concentration of blood glucose is lowered to a normal level, the pancreas stops secreting insulin.

If the glucose level falls too far for example during starvation or fasting, the pancreas detects this and releases glucagon from its alpha cells.

### **Glucagon causes;**

- Liver cells to convert stored glycogen into glucose.
- Fats in adipose tissue to be converted to glucose.
- The rate of oxidation of glucose to slow down.

This raises the blood glucose concentration to approximately normal level.

Once this happens, the pancreas stops producing glucagon.

Failure to produce insulin causes the presence of much glucose in urine a condition known as *diabetes mellitus*.

## **THE LIVER**

The liver is the largest organ in the body of a mammal. It performs several functions, which include the following.

### **1. Regulation of blood sugar level.**

This is done with the help of a hormone called **insulin** from the  $\beta$ - cells of the islets of langerhans, in the pancreas. When the blood sugar level is high, the pancreas produces insulin, which moves to the liver cells through blood. It then stimulates the liver cells to convert some of the glucose into glycogen for storage in the body. When the level of glucose drops in blood, it inhibits the secretion of insulin and stimulates the  $\alpha$ - cell of the islets of langerhans in the pancreas to secrete a hormone called **glucagon**. Glucagon stimulates the liver to convert glycogen and fats to glucose. This raises the level of glucose in the blood.

### **2. Regulation of lipids.**

The liver removes lipids from the blood stream by either breaking them down to release energy or storing them in fat deposits.

### **3. Regulation of amino acids and proteins**

The body cannot store excess proteins and amino acids therefore excess is sent to the liver where the amino group ( $\text{NH}_2$ ) is removed from them and converted into ammonia or urea to be excreted. This occurs in a process

called deamination. The remaining part is broken down to release energy or it is converted into fats for storage.

**4. Detoxification.**

This is the removal of toxic products from the body. All toxic products from any part of the body are taken to the liver where their toxicity is neutralized.

**5. Production of heat**

When the body temperature falls, metabolic processes take place in the liver to produce heat, which restores the temperature back to normal.

**6. Production of bile.**

Bile is manufactured in the liver and stored in the gall bladder.

**7. Formation of cholesterol.**

Cholesterol is a lipid part used in formation of cell membranes.

**8. Elimination of sex hormones.**

After their role is over, the sex hormones are modified and sent to the kidney or expelled into bile by the liver.

**9. Storage of blood.**

The liver has a good network of blood capillaries and most of the blood is stored in these capillaries. It holds more blood than any other body organ.

**10. Storage of vitamins.**

The liver stores most of the fat-soluble vitamins such as vitamin E, vitamin D and vitamin K

**11. Formation of red blood cells.**

In adults the red blood cells are produced from the red bone marrows but in the foetus they are made in the liver.

**12. Elimination of haemoglobin from red blood cells.**

## **THE SKIN**

This is the most extensively distributed tissue found all over the body of mammals. It is a continuous protective layer over the body.

### **Functions of the skin**

- i) To protect the tissue below it from mechanical damage, bacterial and viral infections.
- ii) It also prevents excess loss of water from the body.
- iii) It acts as a sense organ and it is sensitive to pain, touch and heat. This helps the organism to be aware of its environment.
- iv) It helps to keep the body temperature of endothermic organisms constant.
- v) It synthesizes vitamin D in presence of sunlight.
- vi) It acts as an excretory organ. It excretes sweat, which contains urea, water and excess salts.

## Structure of the skin

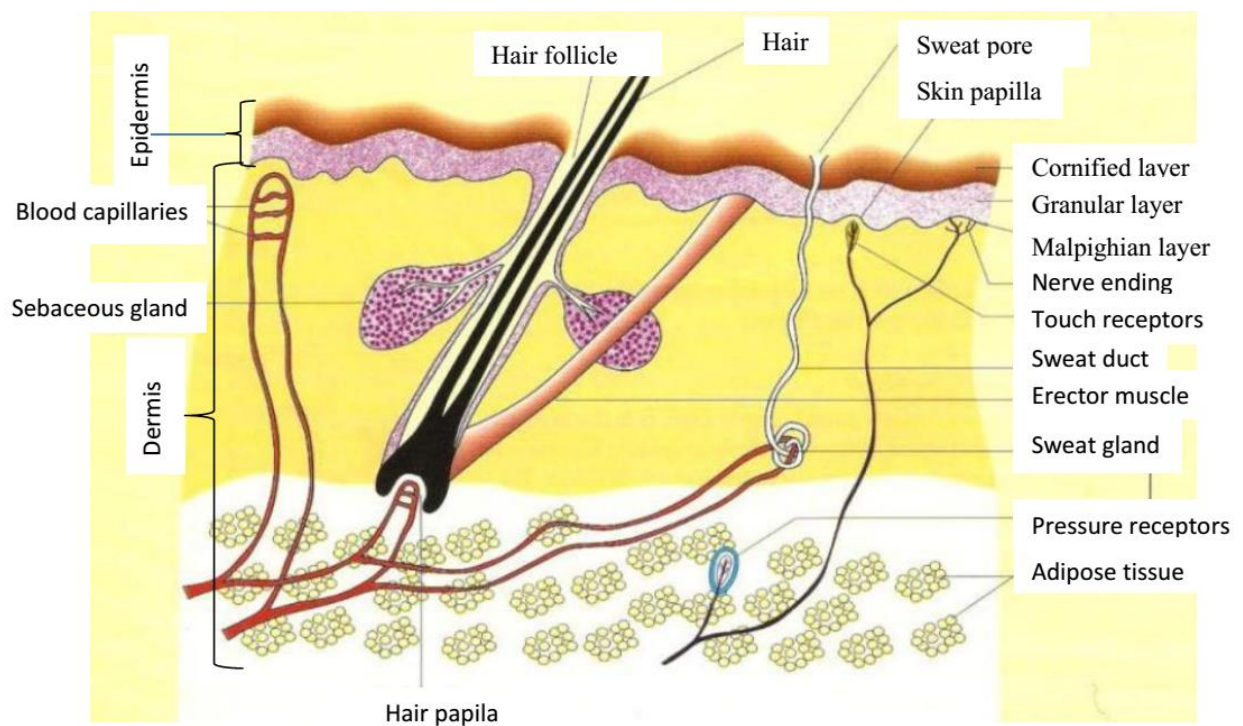

The skin consists of two main layers.

1. The epidermis (outer layer)
2. The dermis (inner layer)

### **THE EPIDERMIS:**

This is made up of three sub layers.

- a) The Malpighian layer.
- b) The granular layer.
- c) The cornified layer.

#### **1) The Malpighian layer**

This is the inner most sub layer in the epidermis. It consists of dividing cells which give rise to cells of the granular layer. It secretes a pigment called

melanin, which gives the skin its colour and protects the skin from ultraviolet rays. Albinos do not produce melanin in their skins.

## **2) The granular layer**

This contains living cells arising from the malpighian layer. It is the biggest layer of the epidermis. It gives rise to cells of the cornified layer.

## **3) The cornified layer.**

This is the outermost layer of the skin. It is made up of dead cells, which are keratinized. Cells of this layer continuously wear away and are replaced by cells from the granular layer. Its function is to protect the inner parts of the body from mechanical injury and entry of bacteria and other germs. It also offers water proofing to the skin.

## **THE DERMIS:**

This is the inner layer of the skin. It is below the Malpighian layer. It is thicker than the epidermis. It contains the sweat glands, nerve fibers, fat cells and blood capillaries.

## **Other parts of the skin**

### **1) Hairs.**

The hairs extend from the dermis through the epidermis. They arise from hair follicles in the dermis. They protect the body and trap a layer of air on the skin, which insulates the body against heat loss.

### **2) Sebaceous gland**

This secretes an oily substance called sebum. This oil softens the cornified layer and prevents it from cracking. The oil also provides water proofing to the skin.

### **3) Nerve endings.**

These perceive external stimuli and transport impulses to the central nervous system.

### **4) Sweat glands.**

These are coiled tubular glands located in the dermis. They excrete sweat, which is released out of the skin through the sweat duct.

## **CONTROL OF BODY TEMPERATURE (Temperature regulation).**

This is the process of maintaining the temperature of the organism within narrow ranges, which favour body activity, and ensures optimum activity of body enzymes.

To maintain the body temperature constant, there must be a balance between heat loss and heat gain.

**The body loses heat by;**

- a) **Radiation:** Heat diffuses from the warm body to the cold environment.
- b) **Conduction:** The body loses heat to the cold object in contact with it.
- c) **Convection:** Where cold air or wind carries heat from the warm body.
- d) **Evaporation:** e.g. sweating leading to loss of heat

**The body gains heat by;**

- a) **Radiation:** e.g. from the sun's heat and reflection from the ground.
- b) **Conduction:** e.g. from the ground via the feet.
- c) **Convection:** e.g. from the wind bringing hot air to the body.
- d) **Metabolism:** e.g. since many of the body's chemical reactions release heat e.g. in respiration.

**The rate of heat loss and gain depends on;**

- a) Surface area to volume ratio i.e.  
Small organisms having a large surface area to volume ratio tend to lose more heat than the large ones with small surface area to volume ratio.
- b) Temperature of surrounding environment:  
Organisms tend to lose more heat in cold environment and gain more in hot environment.
- c) Rate of respiration  
The higher the rate of respiration, the more heat energy gained by the body.
- d) Humidity of the environment  
Heat loss increases in humid conditions because high humidity makes the environment colder.

**Endothermic/Homoiothermic animals:**

Endothermic organisms are those that are able to maintain a constant body temperature irrespective of the surrounding environmental temperature.

They depend mainly on heat generated within their bodies. They are also called warm blooded animals e.g. mammals.

**Ectothermic/poiklothermic animals:**

These are animals that cannot maintain a constant body temperature but their temperature changes with that of the environment. They are also called cold blooded animals e.g. reptiles and amphibians.

**A graph showing how body temperature varies with environmental temperature**

The body temperature of endotherms remains constant despite the increase in surrounding temperature.

The body temperature of ectotherms varies with environmental temperature.

**Control of body temperature in endotherms**

When temperature is high, organisms respond in a way that lowers down the temperature and when the temperature is low, organisms respond in a way that raises their body temperature. These responses are categorized into two types.

- 1. Physiological responses.** These are involuntary actions and they occur in body organs in response to temperature changes.
- 2. Behavioral responses.** These are voluntary responses from the organism. The organism consciously decides what to do when external and internal temperatures change.

**Response to cold weather in endothermic animals****Physiological means.**

1. The erector pill muscles of the hair contract to make the hairs stand upright to the skin. The hairs trap a layer of air, which insulates the skin.
2. The rate of sweating reduces in order to reduce on the amount of heat lost through it.
3. The metabolic activity of the liver increases to produce energy in form of heat.

4. Blood vessels near the skin constrict in the process called vasoconstriction to reduce on the blood reaching the skin. This reduces heat loss through radiation.
5. Small animals like the mouse undergo hibernation where they dig holes and live deep in them to reduce heat loss
6. Shivering. This is the rhythmic contractions of the skeletal muscles. It results into production of heat energy.

### **Behavioral means.**

Endotherms may raise their body temperature behaviorally through;

1. Sitting near hot bodied to raise their body temperature by conduction or radiation.
2. Humans take hot drinks.
3. They do physical exercises to raise the metabolic activity of the body.
4. They can take a hot bath
5. They put on thick clothes, which insulate their bodies.

### **In hot weather**

In hot environment, animals control the body temperature by increasing heat loss and lowering heat production through the following ways:

### **Physiological means.**

1. The erector pilli muscle of the skin relaxes making the hairs to fall on the skin. This allows heat loss by radiation.
2. The metabolic rate of the body reduces to reduce on the amount of heat produced.
3. Sweating increases. In this process excessive heat is lost as latent heat of vaporization to evaporate the sweat from the body hence losing heat.
4. Vasodilatation. Vessels dilate and allow more blood to reach the skin surface in order to lose heat to the surroundings by radiation.
5. Animals living in hot environments have a thin fat layer to reduce on the insulation.

### **Behavioral means.**

1. Some rest on cold bodies like rocks to lose heat by conduction.
2. Humans sit near fans.
3. Some take cold drinks.
4. They put on light clothes
5. Panting. This involves hanging out of the tongue for example in dogs. This results into evaporation from the mouth, which eventually cools the animal.
6. Swimming.

### **Adaptations of mammals to cold conditions**

1. They have a lot of hairs over their bodies to trap a layer of air
2. They have a thick fat layer to act as an insulator.
3. Some are very big and thus have a small surface area to volume ratio. This reduces the rate of heat loss.
4. They have few sweat glands to reduce of the heat lost during sweating
5. They have fewer blood vessels on the skin surface to avoid heat loss through radiation.

#### **Behavioral:**

1. Putting on thick clothes like in humans
2. Doing physical exercises
3. Hibernation. This is a state of long rest by burrowing into crevices and holes during extreme coldness.
4. Sun bathing

### **Adaptations to hot conditions**

1. Having little hairs on the body to allow easy loss of heat.
2. Having less fat to reduce on the insulation effect of fats.
3. Having a large surface area to volume ratio. To allow a faster rate of heat loss.
4. Having a lot of sweat glands to increase heat loss.
5. Having many blood vessels near the skin for easy loss of heat by radiation.

#### **Behavioral:**

1. Resting under shade.
2. Bathing cold water.
3. Aestivation. This is a state of long rest by burrowing in crevices and holes during extreme hotness.
4. Putting on lighter clothes.
5. Sitting near cold things.

### **TEMPERATURE CONTROL IN ECTOTHERMIC ANIMALS**

Ectothermic animals are animals whose body temperature changes with that of the environment. Examples of ectotherms are fish, reptiles and amphibians. Their body temperature is controlled by only behavioral means.

#### **During hot conditions, they lose heat by.**

1. They rest on cold rocks to lose heat by conduction.
2. They rest on cold stones and in shades to lose heat.

3. They burrow in cracks and lose heat by radiation.
4. Aestivation. This is a state of long rest by burrowing underground or under rocks during high temperatures.
5. Thermal gaping. This is the opening of the mouth to lose water by evaporation. This results into cooling. Thermal gaping occurs in crocodiles and a few other reptiles.

#### **During cold conditions, they gain heat by;**

1. Resting on hot rocks to gain heat by conduction.
2. They rest under the sun to gain heat by radiation.
3. They rest near hot bodies to gain heat by radiation.
4. They burrow in hot sand to gain heat by conduction.
5. Basking in the sun to gain heat.
6. Hibernation. This is a state of long rest by burrowing into crevices and holes during extreme coldness.

#### **Merits of being endothermic**

1. They are always active because their temperature is maintained at an optimum temperature for enzyme activity.
2. They can live in a wide range of environments i.e. both hot and cold.
3. Their metabolic rate is maintained at a high rate due to the ability to maintain a constant body temperature.

#### **Disadvantages of being endothermic**

1. Having a high rate of food consumption due to high rate of metabolism.
2. Maintaining the body temperature constant requires much energy.

#### **Advantages of being ectothermic**

1. Low food consumption due to low metabolic rate.
2. Easy to control body temperature by only behavioral means.

#### **Disadvantages of being ectothermic**

1. They have limited body activity in cold environments.
2. Show response to stimuli due to low metabolic rate.

## **CO-ORDINATION AND CONTROL**

This is the ability of an organism to detect and respond to changes in their internal and external environment.

It also refers to linking together of all activities in the body. Coordination is carried out by two systems.

1. Nervous system
2. Endocrine system

*The nervous system is a network of conducting tissue running to all parts of the body and it transmits impulses while the endocrine system is a number of glands in the body, which produce chemicals known as hormones.*

### **Definitions of important terms**

1. **Irritability**; this is the ability of an organism to detect and responds to a stimulus in the environment.
2. **Stimulus**; this is a change in the external or internal environment to which an organism responds.
3. **Response**; this is a change shown by an organism in reaction to a stimulus
4. **Impulse**; this is a nervous information transported along nerves in a nervous system.
5. **Effectors**; these are cells or organs in an organism where a response to a stimulus occurs.
6. **Receptors**; these are cells or organs that receive the stimulus and change it into a nervous impulse.
7. **Internal environment**; this is the immediate surroundings of cells. In animals the internal environment is the tissue fluid.
8. **External environment**; this is the surrounding of the entire organism.

### **COORDINATION AND IRRITABILITY IN PLANTS**

Coordination and control in plants is carried out by hormones. Plants lack the nervous system and information is carried by hormones especially *auxins*.

Plants do not move from one place to another. Their response involves growth movements of part of the plant and turgor changes within cells. Parts of the plant move towards or away from a stimulus due to changes in auxins concentration in the parts concerned.

Plant responses are divided into three categories.

#### **1. Nastic responses.**

This is the movement of part of the plant in response to a non-directional stimulus. This can be observed in the closing of the leaves of *mimosa pudica* when touched (thigmonasty)

#### **2. Tactic responses**

This is a type of response where the whole organism moves towards or away from a unidirectional stimulus. This response is common in lower plants such as *chlamydomonas* and *chlorella*.

### 3. Tropisms

This is a growth movement of part of the plant towards or away in response to a unidirectional stimulus.

#### Note;

Tactic responses and tropisms can be described as negative if movement is away from the stimulus or positive if the movement is towards the stimulus.

The responses are of different types depending on the nature of the stimulus.

### TROPISMS

This is the growth movement of the plant part in response to the direction of stimulus. The direction of response is related to stimulus and the plants move towards or away from it.

#### Characteristics of tropisms

1. It involves growth
2. It is a slow response
3. It occurs at the shoots and root tips
4. It is related to the direction of stimulus
5. It is induced by directional stimulus

#### Importance of tropisms to plants

1. It enables plants leaves to trap maximum sunlight by enabling plant shoots to grow upright.
2. It enables plants to become firmly anchored in the soil by the roots growing towards the ground.
3. It enables plant roots to absorb or obtain water which is necessary for plant growth.
4. It enhances fertilization in plants since the pollen tubes grow towards the chemicals of the embryo sac.
5. It enables climbing plants to gain support by twinning around the support.
6. Tropisms allow plant parts to alter direction in response to changing conditions in the environment.

### TYPES OF TROPISMS

Tropisms are divided into different types depending on the nature of the stimulus.

The table below shows the name of tropism and corresponding stimulus

Name of tropism	Stimulus
1. Hydrotropism	Water

2. Thigmotropism / haptotropism	Touch
3. Chemotropism	Chemicals
4. Geotropism	Gravity
5. Phototropism	Light
6. Aerotropism	Air

**Hydrotropism;** this is the growth movement of part of a plant towards or away from water.

**Thigmotropism;** this is the growth movement of part of a plant in response to touch.

**Chemotropism;** this is the growth movement of part of the plant towards or away from a particular chemical e.g. pollen tube grows towards the embryo sac through the style during fertilization by responding to the source of chemicals produced by the embryo sac.

**Geotropism;** this is the growth movement of part of the plant in response to gravity.

**Aerotropism;** this is the growth movement of part of the plant towards or away from air.

**The table below shows some of the tropic movements shown by plants**

Type of tropism	Stimulus	Positive response	Negative response
Phototropism	Light	Shoot	Root
Geotropism	Gravity	Root	Shoot
Hydrotropism	Water	Roots	Shoots
Chemotropism	Chemicals	Pollen tube	-
Thigmotropism	Touch	Tendrils of passion fruits	Root tips when in contact with an obstacle

## **PHOTOTROPISM**

This is the growth movement of part of the plant in response to unidirectional light. Plant shoots are positively phototropic that is, they grow towards the direction of light while the roots are negatively phototropic (they grow away from the direction of light).

## **AUXINS AND PHOTOTROPISM**

Light from one direction of the shoot causes auxins on that side to escape to the opposite side without light.

The side without light receives more auxins than one receiving more light. A high concentration of auxins on the side with little or no light increases the rate of cell division and elongation on that side. This causes the shoot to bend towards the direction of light (positive phototropism)

### Illustration

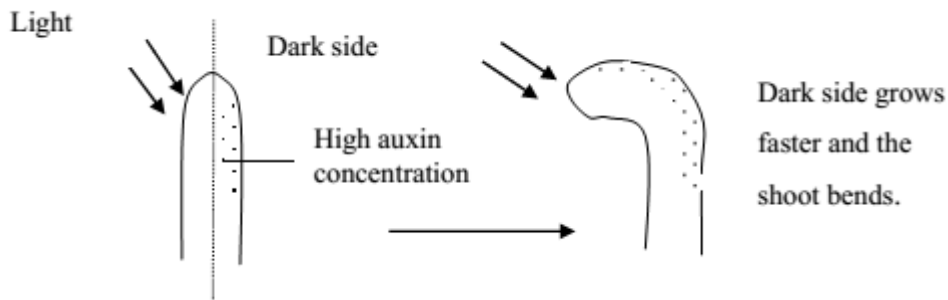

However, high auxins concentration limits growth in plant roots

## EXPERIMENT TO SHOW THE EFFECT OF UNIDIRECTIONAL LIGHT ON GROWTH OF THE PLANT SHOOT

### Materials

2 Potted plants, 2 opaque boxes, klinostat and Razor blade

### Procedure

- Get two opaque boxes and using a razor blade cut a small hole on one side of each.
- Get two potted plants of equivalent size.
- Place one in box A and another in box B but fixed on a klinostat to serve as the control experiment. Place both boxes in light and start the klinostat to rotate the plant in box B.
- Leave the experiment for 3-4 days.

### Setup

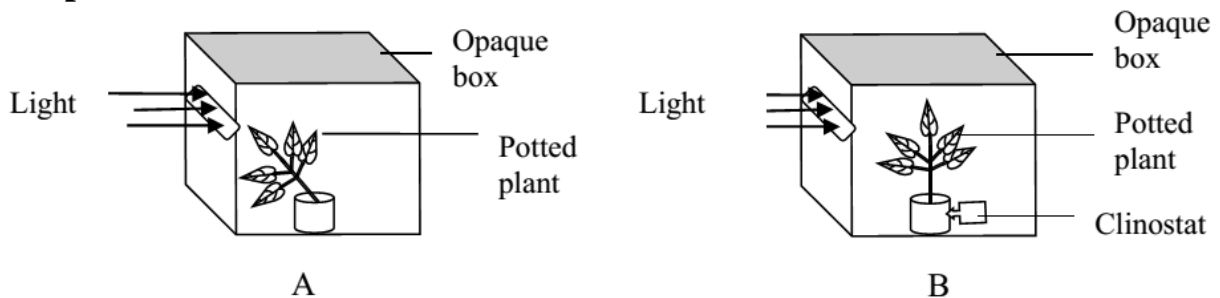

**Observation:**

The shoot in A bent towards the direction of light while that in B continued to grow straight.

**Explanation:**

Light coming from one direction in A made the stationary shoot to bend towards the direction of light. Because the shoot in B was rotating on a clinostat all of its sides received equal amounts of light and there was no effect on growth.

**Conclusion:**

The shoot responds positively towards light.

### **PHOTOPERIODISM**

This is the response of an organism mainly plants to the relative length of light and dark periods. It mainly affects the production of flowering hormone florigen.

Some plants need a relatively longer period of light for flowering. Such plants have a rich vegetative growth if the light period is long. ( long day plants)

Some plants need a short period of light of flowering e.g. tomatoes, such plants have a rich vegetative growth if the light period is short (short day plants)

Duration of light has no effect on some plants e.g. sun flower in any season (day neutral plants)

Due to the above facts, particular plants are grown in particular seasons.

### **GEOTROPISM**

This is the growth movement of the plant part in response to the direction of the force of gravity. Roots grow towards the direction of force of gravity hence positive geotropism.

### **AUXINS AND GEOTROPISM**

When a shoot is placed horizontally on the surface, auxins move in response to the gravitational force to the lower side. Cell division and elongation takes place more on the lower side than the upper side. This makes the shoot to bend upwards away from the gravitational pull (negative geotropism)

In the root, a higher concentration of auxins on the lower side reduces the rate of cell division and elongation in the root. The upper side grows faster than the lower side causing the root to bend in the direction of the gravitational force (positive geotropism)

### Illustration:

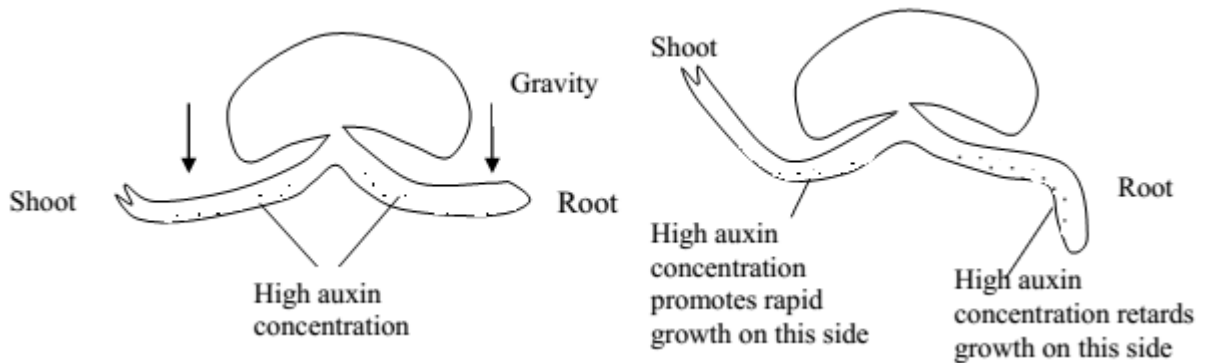

## EXPERIMENT TO DEMONSTRATE GEOTROPISM IN PLANT ROOTS (THE EFFECT OF GRAVITY ON ROOTS)

### Materials

Cotton wool, Seeds, Petridishes, Water, clinostat, Plasticin

### Procedure

- Place seeds in two petridishes and cover them with moist cotton wool.
- Leave the seeds for about 3 days to develop radicles.
- Place one petridish in plasticin perpendicular to the ground making the radicles horizontal to the surface.
- Place another petridish on a clinostat and make its radicles horizontal to the ground.
- Start the clinostat to rotate such that all sides of the radicles receive the same gravitational pull.

**Setup:**

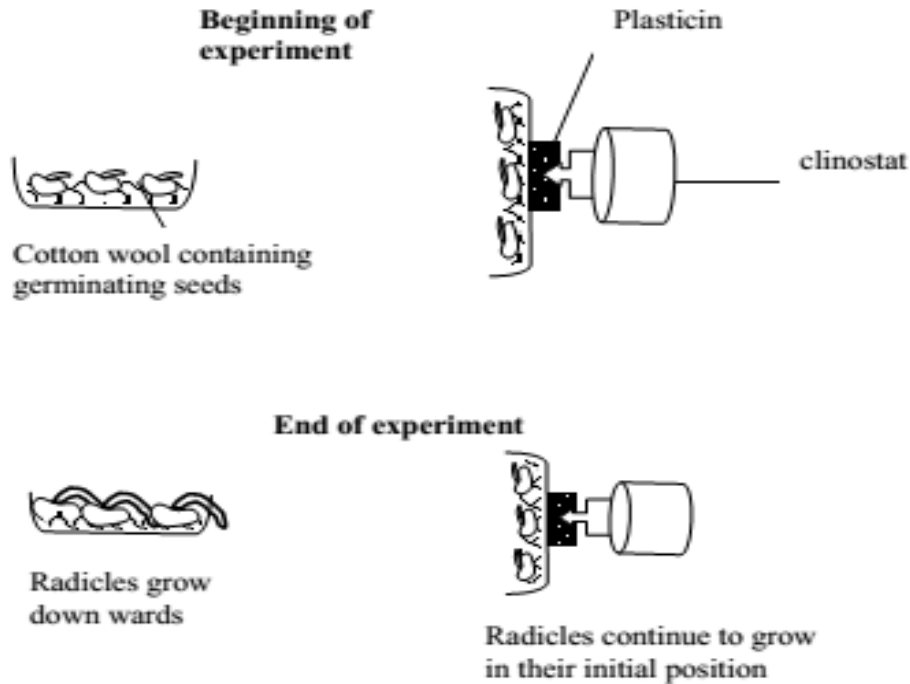

**Observation:**

The radicles in setup A bent downwards and those in B continued to grow horizontally.

**Conclusion:**

Roots are positively geotropic.

**HYDROTROPISM**

This is the growth movement of a plant and part in response to a unilateral source of water. The roots grow towards the source of water hence show positive hydrotropism. The shoots grow away from the source hence negatively hydrotropic.

**EXPERIMENT TO SHOW HYDROTROPISM IN ROOTS**

**Materials:**

- Wire gauze
- Water
- Seedlings
- Trough
- Anhydrous  $\text{CaCl}_2$

**Procedure:**

- a) Place wire gauze horizontally above a trough containing water.
- b) Place moisture cotton wool on the trough leaving some spaces through which the radicle can pass.
- c) Place germinating seedlings on cotton wool.
- d) For the control set up a similar experiment but with a trough containing anhydrous  $\text{CaCl}_2$  instead of water.
- e) Leave the experiment for 3 days.

### Experimental set up

#### **Observation:**

In A, the radicle grow towards water while in B, they curve away from dry air.

#### **Conclusion:**

Roots positively respond to water i.e. positively hydrotropic.

#### **Explanation:**

The calcium chloride absorbs moisture from the bottom of the trough. The upper part of the trough remains moist hence the radicle bend upwards towards the moisture.

#### **NOTE:**

Consider the demonstration of hydrotropism below.

1. The empty porous pot was put in a dish containing moist saw dust. After elongation of the radicles, watering of the saw dust stopped and instead water is poured in the porous pot.
2. The experiment is then left to stand for 4 days.

#### **Setup:**

The control experiment for the above experiment is set up as above but without water in the porous pot.

**Observation:**

Where water was poured in the porous pot, the radicles grew towards the pot unlike in the control experiment.

**Conclusion:**

Roots (radicles) are positively hydrotropic.

**CONTROL OF RESPONSES IN PLANTS**

Responses in plants are controlled by a group of plant hormones especially auxins. These auxins are produced at the root and shoot tip and are transported in the phloem together with manufactured food.

Auxins control responses by controlling growth through stimulation of cell elongation. High auxins concentration stimulates faster growth in shoots and inhibits growth in roots.

Light affects the distribution of auxins. When the shoot tip is illuminated from one side, auxins diffuse to the dark side there by causing faster growth on the dark side becomes longer than the illuminated side. This causes the shoot to bend towards light.

Gravity also affects the distribution of auxins. If a seedling is lying horizontally, more auxins will diffuse on the lower side of the root and shoot due to gravity.

In roots, the high concentration of auxins inhibits growth causing the lower side to grow slowly, while the upper side grows faster. This results in the roots bending towards gravity.

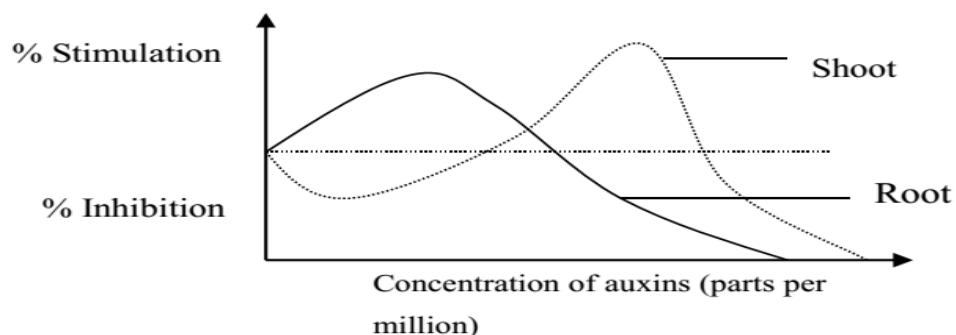
**Graph showing the effect of auxins concentration on the growth of roots and shoots.**

When the concentration of auxins increases, growth in the shoot also increases to a maximum beyond which, further increase in auxins concentration inhibit growth in shoots. Growth response in the root decreases with increase in auxin concentration.

**Importance of auxins**

- ✓ Causes apical dominance
- ✓ Leads to parthenocarpy
- ✓ Causes tropism
- ✓ Causes rooting of the stem cutting.

## **PLANT GROWTH SUBSTANCES**

### **1. Indole Acetic Acid (IAA)**

It is a naturally occurring growth substance in higher plants. It influences cell elongation and root initiation. It has a powerful effect on growth. It also brings about development of parthenocarpic fruits. It also checks formation of branches from side buds. If IAA is applied to the cut end of the main stem, the side buds don't develop into branches.

### **2. Gibberellins**

They are produced by plants in varying amounts in seeds and young plants. If a solution of gibberellins is sprayed on a plant, it increases the water absorbing capacity of the cells. Gibberellins also contribute to flowering and growth of fruits.

### **3. Cytokinins**

These promote cell division but only in the presence of auxins. They are also synthetic chemical compounds which are used for promoting or controlling growth. Some are used in killing weeds.

## **EXPERIMENTS TO SHOW THAT AUXINS ARE RESPONSIBLE FOR GROWTH**

### **Materials**

- ✓ Coleoptiles (plant seedling)
- ✓ Razor blade

### **Procedure**

Using a razor blade cut off the tip of the coleoptile and leave it to stand for 3-6 days.

### **Setup**

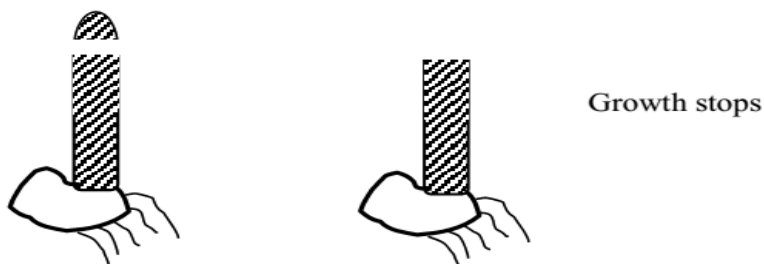

**Observations**

Growth stops taking place.

**Explanation**

The coleoptile tip produces new cells by cell division and it also produces a growth-promoting chemical. When the tip is cut off, growth stops.

**EXPERIMENT TO SHOW THAT AUXINS ARE DIFFUSABLE  
SUBSTANCES**

1. Tips of shoots are removed and then placed on an agar block.
2. Tips are then discarded or thrown away and the agar blocks placed on the decapitated shoot.
3. It is observed that growth continues.

If auxins are prevented from diffusing to the lower side by a razor blade or a mica plate curvature growth occurs. The shoot grows towards the side of the razor blade or the mica plate.

This is because the razor blade blocks the movement of auxins on that side therefore the side without the block grows faster than the side with the blade.

**EXPERIMENT TO SHOW THAT CUTTING OFF THE COLEOPTILE  
ALONE DOES NOT STOP GROWTH****Materials**

Coleoptile, Razor blade and Mica

### Procedure

Using a razor blade cut off the tip of the coleoptile. Place a piece of mica on the cut surface of the shoot and replace the tip

### Setup

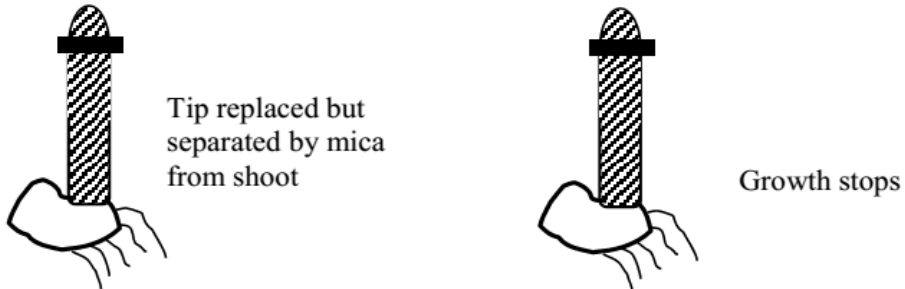

### Observation:

No growth takes place

### Explanation:

Mica prevents both cells and auxins from getting down to the shoot.

## EXPERIMENT TO SHOW THAT AUXINS OTHER THAN THE CELLS ARE RESPONSIBLE FOR GROWTH

### Materials:

Agar block, Coleoptile and Razor blade

### Procedure:

Cut off the tip of the coleoptile using a razor blade. Place back the tip but separated from the coleoptile by the agar block.

### Setup:

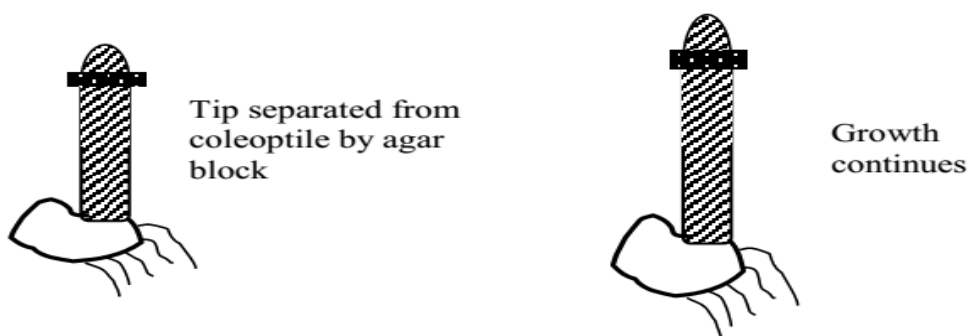

### Observation:

Growth continued

**Explanation:**

This shows that auxins were able to diffuse from the tip to the coleoptile through the agar block whereas the agar block cannot allow cells to pass through.

## **EXPERIMENT TO INVESTIGATE THE EFFECT OF AUXIN DISTRIBUTION ON PLANT GROWTH**

**Materials:**

Coleoptile and Razor blade

**Procedure:**

Insert a razor blade on one side of the coleoptile tip and leave it to grow.

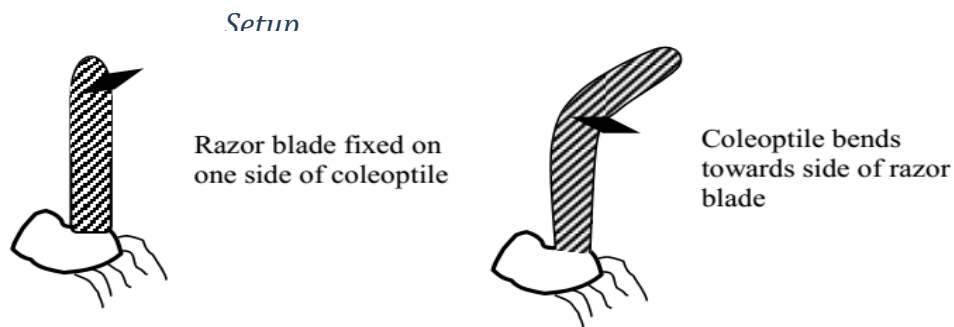
**Observation:**

The coleoptile continues to grow bending towards the side with the razor blade.

**Conclusion:**

The side without a razor blade grows faster than the one with a razor blade causing the coleoptile to bend towards the side with a razor blade.

**Explanation:**

In equal illumination, auxins are equally distributed in the shoot. The insertion of a razor blade on one side prevents auxins from moving down on that side. Unequal distribution of auxins causes uneven growth of the shoot.

## **EXPERIMENT TO SHOW THAT UNEQUAL AUXIN DISTRIBUTION IS RESPONSIBLE FOR BENDING**

**Materials**

Agar block, Coleoptile and Razor blade

## Procedure

Using a razor blade cut the coleoptile tip and place it on a piece of agar for 1 hour for auxins to penetrate it. Place the agar block on one side of the cut end of the shoot. Leave the experiment for 3-4 days.

## Setup

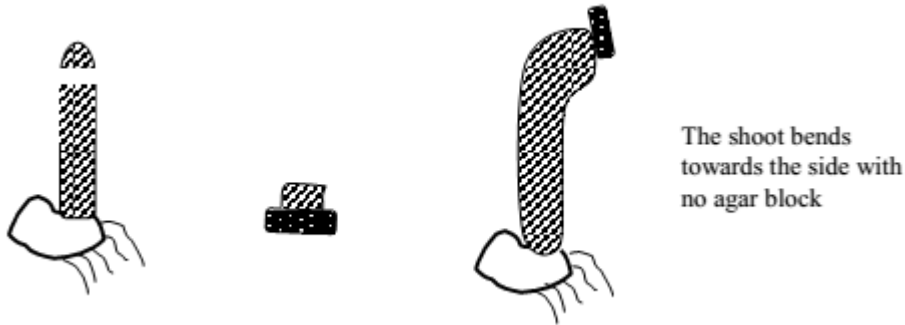

## Observation

The shoot bends to the side with no agar block

## Conclusion

Unequal distribution of auxins is responsible for unequal growth of the plant shoot.

## Explanation

The auxins diffuse from the agar into the side of the shoot where the agar is placed. This causes the cells on that side to divide and elongate faster causing the shoot to bend.

## EXPERIMENT TO FIND OUT THE REGION OF ELONGATION IN A ROOT

### Materials:

- ✓ Water
- ✓ Ink
- ✓ Cock
- ✓ Seedlings
- ✓ Conical flask
- ✓ Dark cup board
- ✓ Pin

### Procedure:

- a) Take bean seedlings with straight radicles.
- b) On each seedling mark the radicle every 2mm with lines in black ink.
- c) Pin the seedlings to the other side of the cork with the radicles hanging downwards.
- d) Insert the cork into the neck of the flask containing little water.
- e) Put the flask in the dark cupboard for 3-4 days.

**Experimental set up:**

**Observation:**

Some lines on the radicle are 2mm apart while others are more than 2mm apart.

**Conclusion:**

The region where the lines are further apart is the zone of elongation (region of growth).

## **TACTIC RESPONSE (TAXIS)**

This is the movement of whole organism or cell from one place to another in response to a directional stimulus.

It is a positive tactic response when the whole organism moves towards the stimulus and negative tactic when the organism moves away from the stimulus.

### **Types of taxis**

1. Phototaxis in response to light
2. Chemotaxis in response to chemicals
3. Thigmotaxis in response to touch
4. Geotaxis in response to gravity

### **Examples of taxis**

1. Unicellular organisms e.g. Euglena swim towards light hence positively tactic (phototactic)
2. Earth worms, wood lice and cockroaches move away from light hence negative phototactic.
3. Sperms swim towards the chemical produced by the ovum hence positively chemotactic.
4. White blood cell moves towards harmful bacteria in the body hence positively chemotactic.

## **NASTIC RESPONSE (NASTIC)**

This is the movement of a plant part in response to a non-directional stimulus or it is a response in which plants are not related to the direction of stimulus but to its intensity.

Nastic response are named depending on the type of stimulus i.e. Photonasty if the stimulus is light.

Hydronasty if the stimulus is water

Thigmonastic if the stimulus is touch

Lastic movements do not involve growth.

### **Characteristics of nastic**

- 1) It involves changes of turgidity of plant cells.
- 2) It is a rapid response.
- 3) It occurs in any part of a plant
- 4) The response is not related to the direction of the stimulus
- 5) It is induced by non-directional stimulus.

### **Examples of nastic response**

- 1) Opening and closing of flowers in response to light e.g. morning glory.
- 2) Sudden closer of leaf lets of mimosa pudica in response to touch.
- 3) Closures of leaves of insectivorous plants e.g. butter walt and pitcher plant where the insect lands on the leaf. Such plants are found in nitrogen deficient soil.

### **Similarities between nastic and tropic movement**

- ✓ Both are brought about by external stimulus.
- ✓ Both occur in plants
- ✓ Both involves movement of plant parts.

### **Differences between tropisms and nastic responses**

<b>Nastic response</b>	<b>Tropism</b>
i) Does not depend on the direction of the stimulus.	It depends on the direction of the stimulus
ii) It occurs in any part of the plant.	It occurs in growing tips of plants
iii) It does not involve auxins	It involves auxins
iv) Are usually faster	Are usually slower
v) It involve growth and turgor changes	It involves growth only.

## CO-ORDINATION IN ANIMALS

All living organisms are sensitive to changes taking place within their surroundings. They detect the changes (stimuli) and respond to them appropriately. The ability of an animal's body to detect and respond appropriately to stimuli depends on the nervous system and endocrine system.

The stimuli may be within an animal's body or in its surrounding. Different parts of the body of an animal do not work independently of each other.

They depend upon one another performing various functions as a single unit. The nervous system controls all the organs and makes them to work together.

## THE NERVOUS SYSTEM

This is a system of nerve cells and sensory organs that carry out co-ordination by transfer of impulses.

+

### COMPONENTS OF THE NERVOUS SYSTEM

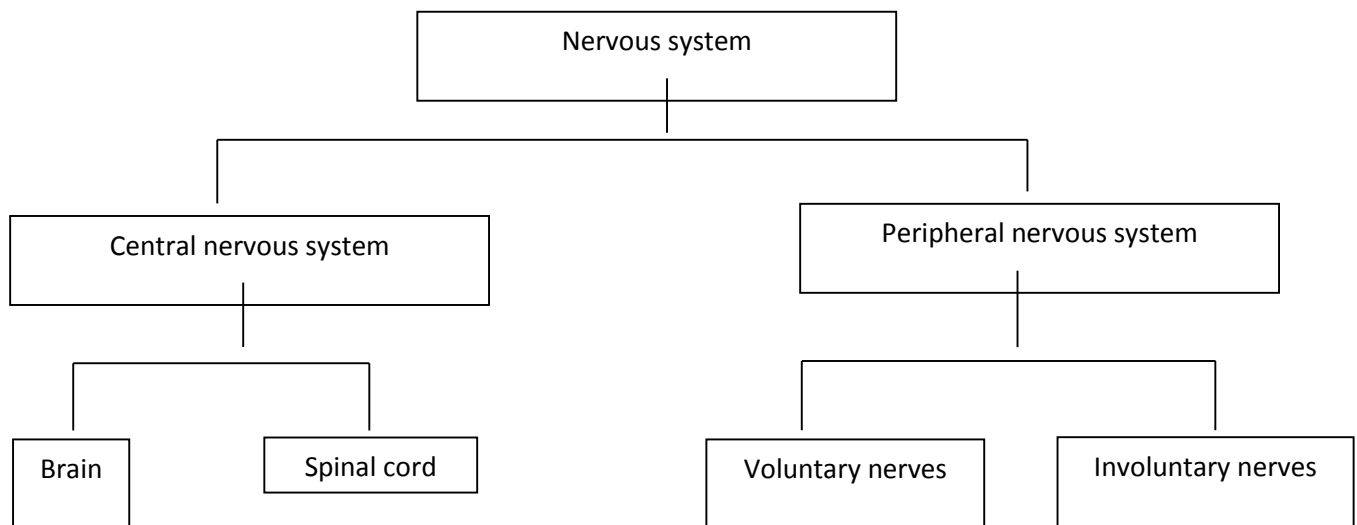

The nervous system consists of;

**i) Receptors:**

These detect the stimuli e.g. sensory endings in the skin, eye and ear.

**ii) The central nervous system (CNS)**

This interprets and determines the nature of the response. The CNS consists of the brain and spinal cord.

**iii) Peripheral nervous system**

This consists of voluntary and involuntary nerves.

**iv) Effectors**

These are organs that carry out the response.

### **Functions of the nervous system**

1. It receives impulses from all sensory organs of the body.
2. It stores information
3. It correlates various stimuli from different sensory organs
4. It sends messages to all parts of the body making them function accordingly.
5. It's involved in temperature regulation.

The nervous system is made up of cells called neurons. A neuron is a functional unit cell of the nervous system that transmits an impulse or an electrical message.

### **STRUCTURE OF THE NEURONE**

A neuron is made up of a small mass of cytoplasm, a nucleus in a structure called the cell body, branching cytoplasmic filaments called dendrites and a single long fiber called axon.

**There are three types of neurons.**

1. Sensory neuron
2. Motor neuron
3. Interneuron (relay neuron)

### **SENSORY NEURON**

These are neurons that transport impulses from the receptors to the central nervous system. A sensory neuron has a single elongated dendrite called a dendron consisting of a fluid filled cytoplasmic tube. It has a cell body in the middle of a short axon and dendron. It is sometimes surrounded with myelin sheath. The myelin sheath increases the speed of the impulse in the neuron.

### **Structure of the sensory neuron**

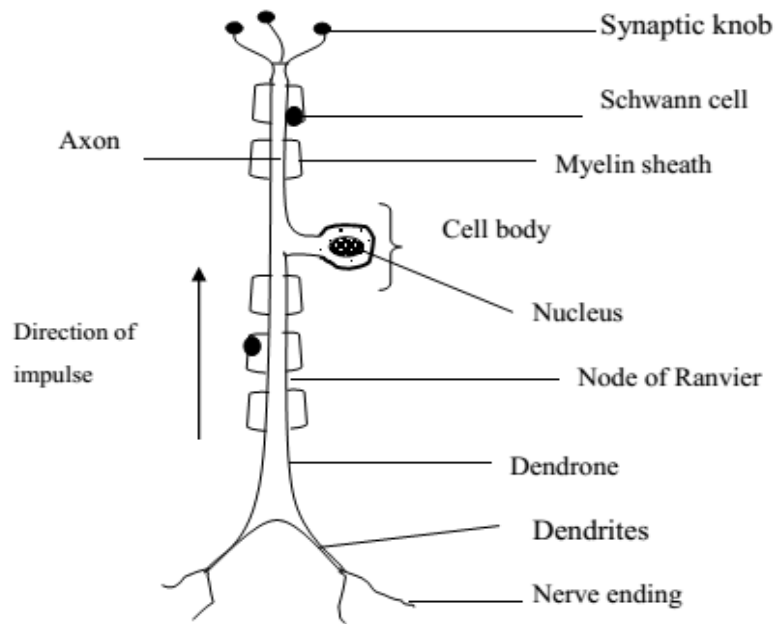

### **Characteristics of a sensory neuron**

- ✓ It has a cell body as a branch on the axil.
- ✓ It has one dendron
- ✓ The axon and dendron may be covered with myelin sheath.
- ✓ The myelin sheath is broken at points called nodes of Ranvier.
- ✓ It has a short axon
- ✓ It has a long dendron
- ✓ The terminal branches are embedded in the receptor.

### **THE MOTOR NEURONE**

This is a neuron that carries impulses from the central nervous system to the effectors. Motor neurons consist of short dendrites with a cell body at one end of a long axon. It is also sometimes surrounded by the myelin sheath.

### **Structure of the motor neuron**

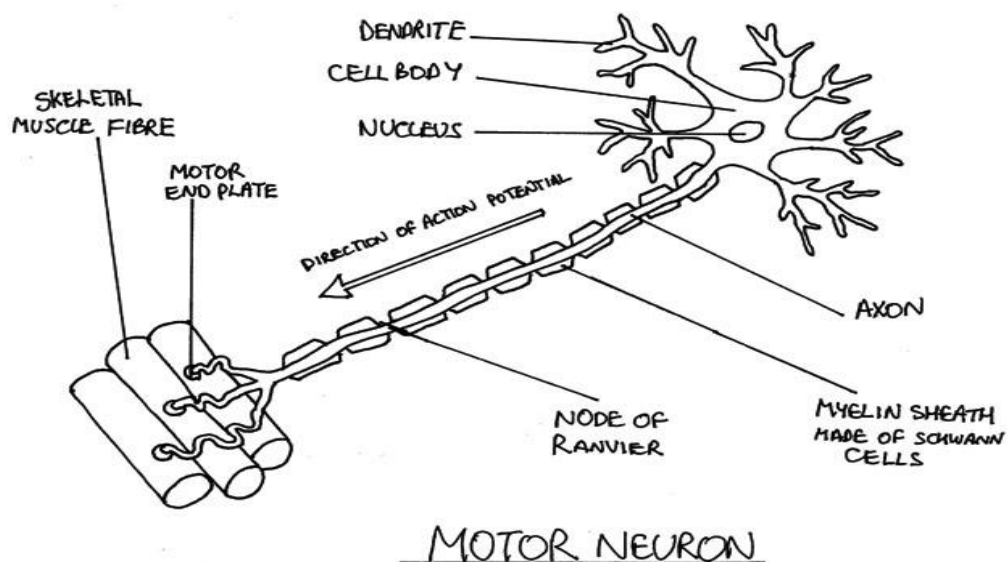
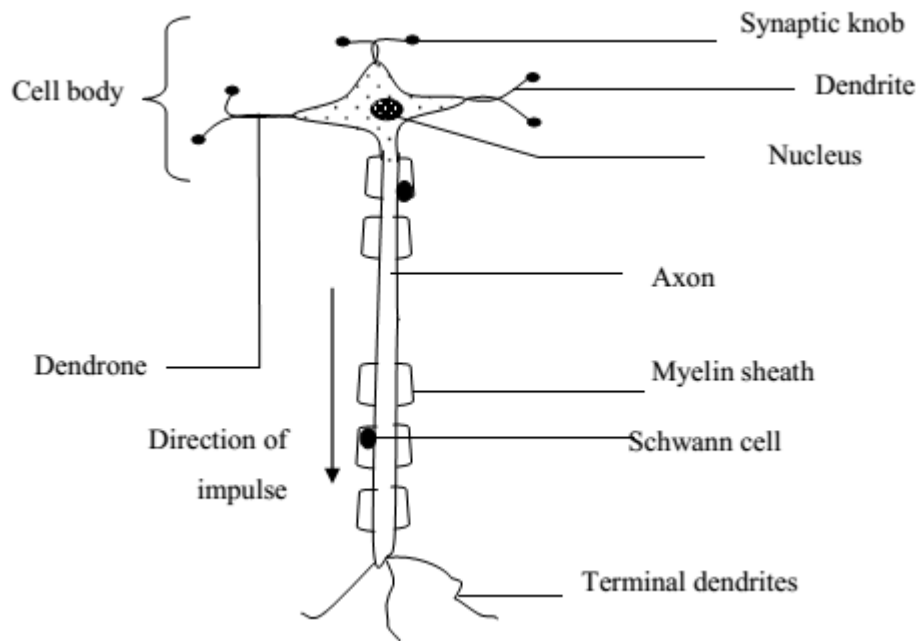

### Characteristics of motor neuron

- ✓ At one end there is a thick part called the cell body which contains the nucleus and cytoplasm.
- ✓ The cell body has dendrones which branch into dendrites.
- ✓ From the cell body is a long fibre called axon.
- ✓ The axon may be covered with myelin sheath.
- ✓ The myelin sheath is broken at points called nodes of Ranvier.
- ✓ The axon ends in branching terminals or end branch.
- ✓ It has many dendrones
- ✓ The terminal branches are connected to an effector.
- ✓ It has a short dendron

## THE INTERNEURONE (RELAY NEURON)

This is a neuron found in the central nervous system and carries impulses from the sensory neuron to the motor neuron.

### Structure of the relay neuron

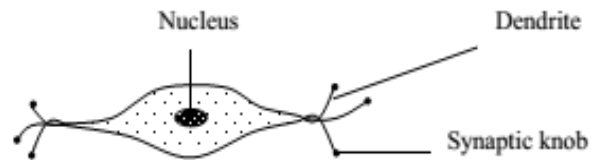

### Characteristics of relay neuron

- ✓ Its fibres are not insulated i.e. have no myelin sheath.
- ✓ Its cell body is in the middle of the fiber.

### General functions of the parts of a neuron

1. **Cell body**; this consists of a nucleus surrounded by a mass of cytoplasm. The nucleus controls all activities of the neuron.
2. **Axon**; this is one or more long cytoplasmic extensions running from the cell body. Axons carry impulses over long distances in the body. Each axon is filled with cytoplasm called **axoplasm**.
3. **Myelin sheath**; this is a fatty material that covers the axon. The myelin sheath is secreted by cells called **Schwann cells**. The myelin sheath insulates the axon and speeds up transmission of impulses.
4. **Dendrites**; these are fine structures on the neuron that link up nerve cells to form a complex network of communication.
5. **Schwann cell**; this is a cell which secretes the myelin sheath.
6. **Node of Ranvier**; this is the space on the axon between two adjacent myelin sheaths. It speeds up nervous transmission.
7. **Cytoplasm**; this is a site for chemical reactions in the neuron.
8. **Dendrone**; it is a branch through which impulses are transmitted to the body.

### Comparison between motor and sensory neurons

#### Similarities:

1. They both transmit impulses.
2. They both have a nucleus.
3. They both have an axon, dendrites and cytoplasm.
4. In both impulses move in one direction.

**Differences:**

<b>Motor neuron</b>	<b>Sensory neuron</b>
i) Has a long axon	Has a short axon
ii) It has a cell body at the terminal end of the axon	Has a cell body located on the axon branch.
iii) It has a short dendron	It has a long dendron
iv) It carries impulses from the central nervous system to the effectors	It carries impulses from the receptors to the central nervous system.
v) It has several dendrones	It has one dendron
vi) Terminal dendrites connect with effectors	Terminal dendrites connect to interneurons.

**THE NERVE IMPULSE**

An impulse is an electric message transmitted along the nerve fibres. It moves very fast as ions. The nerve impulse is initiated by stimulation of receptors by a given stimulus e.g. light, sound etc. the stimulus causes enough stimulation to a point that triggers off an impulse called the threshold level. If the stimulation does not reach the threshold, no impulse is formed and that stimulus is not detected.

**TRANSMISSION OF AN IMPULSE**

When a stimulus reaches a receptor cell, it generates an impulse which is passed to the cell body of a neuron. The impulse is then transmitted from one the dendrites of another neuron via a gap called the *synapse*.

The arrival of an impulse at the end of an axon triggers the release of the transmitter substance into the synapse. This diffuses across the gap and stimulates the dendrites of an adjacent neuron to form an impulse hence the impulse being passed on.

After the passage of an impulse across the synapse, the transmitter substance is destroyed and a new one is made within the axon.

The mechanism ensures that an impulse travels only in one direction across a synapse.

**THE SYNAPSE**

A synapse is a junction or space between the terminals of two adjacent neurons. This junction links the dendrites of one neuron to the dendrites of another adjacent neuron. Movement of impulses across the synapse occurs by secretion

of a chemical called a transmitter chemical in the space known as the synaptic cleft.

### Structure of a synapse

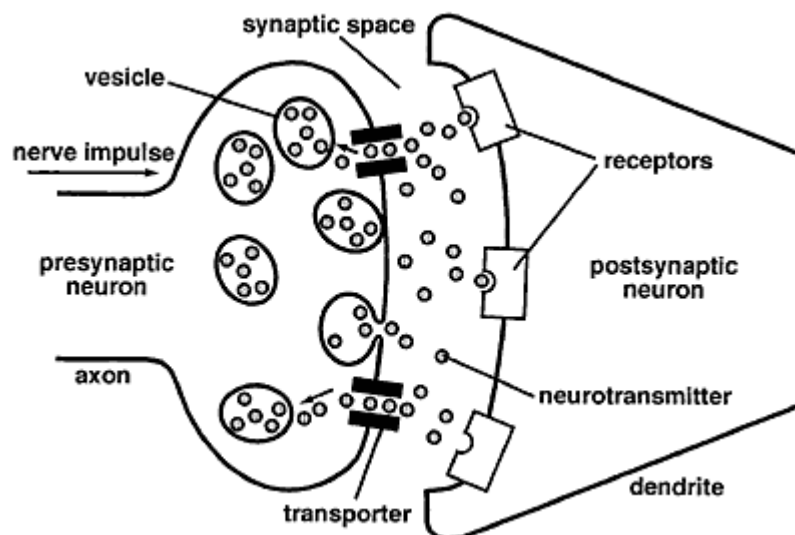
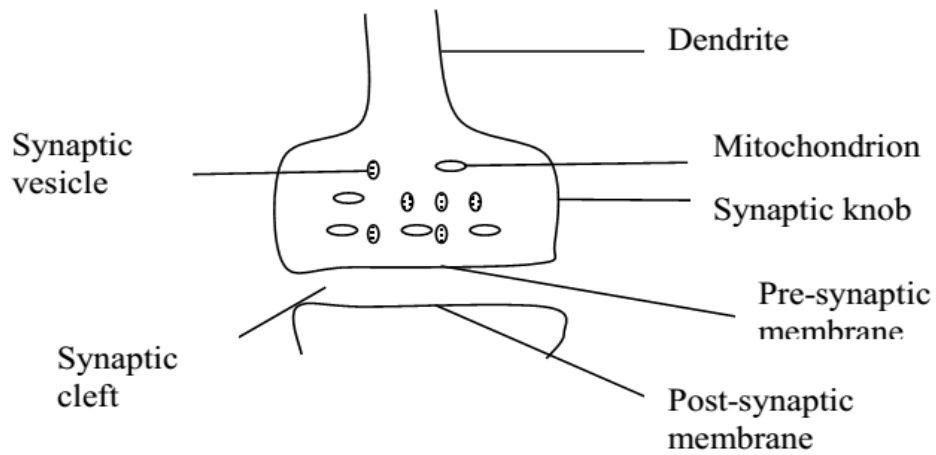

A single impulse may fail to get across the synapse and it may require two or more impulses arriving quickly in succession (one after the other); *temporal* or

simultaneously (at the same time) from two or more neurons. This is termed as **summation**.

Sometimes inhibitory chemicals are secreted into the synapse and when an impulse comes, it gets blocked. This is referred to as **inhibition**.

### **Functions of the synapse**

- 1) It enables propagation (movement) of an impulse from one neuron to another.
- 2) It ensures that an impulse moves in one direction by having vesicles on one side of the synapse.
- 3) The synapse acts as a junction in the nervous system that can diverge, or converge information.
- 4) It prevents continuous stimulation of body organs.

## **PARTS OF THE NERVOUS SYSTEM**

### **THE CENTRAL NERVOUS SYSTEM**

This is made up of the brain and spinal cord.

### **THE BRAIN**

#### **Structure of the brain**

The brain is covered and protected externally by the skull (cranium) and internally by membranes called meninges.

### **Functions of the brain**

1. It receives impulses from all receptors and sends back impulses to the effectors.
2. It integrates and coordinates all activities in the body such that the body works efficiently.
3. It stores information.
4. It is involved in cranial reflex actions but it does not initiate them.

The brain is divided into three major regions, that is;

1. Fore brain

2. Mid brain
3. Hind brain

## 1. The fore brain

It consists of:

### i) The cerebrum (cerebral hemisphere)

This is the largest part of the brain.

It is made up of 2 hemispheres i.e. the left and the right cerebral hemispheres.

The right hemisphere controls the activities of the left side of the body while the left hemisphere controls the activities of the right side of the body. The 2 hemispheres are joined by a fibre known as *corpus callosum*.

It controls all voluntary activities

It is a center of memory and reasoning.

It receives impulses from the sense organ of smell, touch, sight, taste and sound.

### ii) The olfactory lobes:

These are paired lobes located ventrally at the base of the cerebrum.

They are small in size. They receive impulses from the olfactory nerves bringing about the sense of smell.

## 2. The mid brain

It consists of:

### i) Thalamus

It integrates sensory impulses from the eyes, skin and ear and sends them to the cerebral cortex of the cerebrum.

It also directs impulses from all parts of the body to particular areas of the brain.

### ii) Hypothalamus

It is a centre of many activities. It is below the thalamus.

It controls involuntary activities e.g. water and salt balance (osmoregulation)

Controls body temperature, CO<sub>2</sub>, levels in blood, appetite, sleep, hunger, wakefulness, sex drive and produces hormones e.g. oxytocin and ADH which are stored in the pituitary gland.

### iii) Pituitary gland

It secretes a number of hormones like the thyroid stimulating hormone, FSH, LH, ADH, etc. which control various activities.

It also controls other endocrine glands in the body thus called the *master gland*.

#### iv) **Optic lobes**

These are paired lobes. Their main function is to interpret sight.

### 3. **Hind brain**

It is made up of:

#### i) **Cerebellum**

This is concerned with maintenance of balance, locomotion and posture. It receives impulses from the skeletal muscles.

#### ii) **Medulla oblongata**

This controls involuntary actions like yawning, vomiting, blinking of the eye, etc. any injury to this region leads to instant death.

## **THE SPINAL CORD**

This is part of the central nervous system that runs from the brain to the tail through and covered by the vertebral column.

### **Functions of the spinal cord**

1. It connects the peripheral nervous system to the brain.
2. It is a center for simple spinal reflex actions
3. Receives impulses from receptors
4. Interprets messages especially in reflex arc
5. Sends impulses to the receptors.

## **VOLUNTARY AND INVOLUNTARY ACTIONS**

The nervous system controls several actions in the body. Such actions may be voluntary or involuntary.

*A **voluntary action** is one initiated consciously under the direct control of the brain i.e. they are actions one at will e.g. dancing, laughing, stealing, etc.* These actions are performed consciously by an animal. In such actions the animal chooses to do or not to do something.

***Involuntary actions** are the ones that occur without conscious thoughts e.g. breathing, etc.*

## **THE REFLEX ACTION**

This is a rapid automatic response of an organism, which is not initiated by the brain. Reflex actions take place without the awareness of the individual. A

reflex action occurs as a result of impulses travelling along neurons in a path called a reflex arc.

### **Characteristics of a reflex action**

- ✓ It occurs rapidly i.e. The action occurs very fast.
- ✓ It is inborn (innate) but not learnt.
- ✓ It is co-ordinated by either the brain or spinal cord but usually initiated by spinal cord.
- ✓ It occurs without one's will.
- ✓ It is a repeated response to a similar stimulus.
- ✓ Three neurons are involved.

### **Examples of reflex actions**

- 1) Blinking when a foreign body falls on the eye
- 2) Withdraw of the arm when someone accidentally touches a hot body.
- 3) Sneezing
- 4) Knee jerk i.e. a relaxed leg gives a forward kick when tapped slightly below the patella.
- 5) Withdraw of the foot from a sharp object.

### **Example of a simple reflex action**

1. When one accidentally touches a hot body using a finger, the receptors in the finger receive the stimulus and change it into nervous impulses that travel along the sensory neuron to the spinal cord and then cross the synapse.
2. The impulse is then handed over to the relay neuron in the spinal cord (gray matter) and then cross another synapse.
3. The relay neuron in turn hands over the impulse to the motor neuron.
4. The motor neuron then carries the impulse from the spinal cord to the effector muscles of the hand. This causes the muscles to contract and the hand is removed from the hot body.
5. At the same time, the original message is sent to the brain which then interprets it as pain or heat.

**Note;** these processes occur rapidly in the body without the awareness of the individual

## Illustration

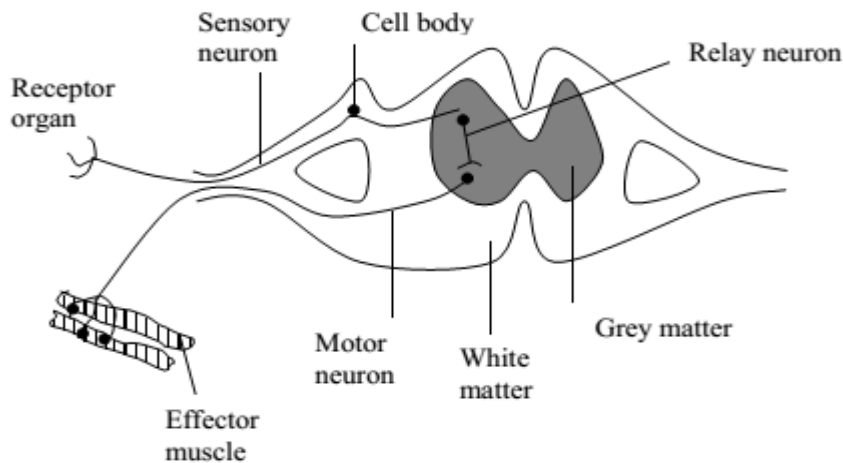

### Advantages of reflex actions to animals

1. They help animals to avoid danger.
2. They control activities in the body, which we do not have conscious control over.
3. They form a basis of some animals' behaviour, e.g. amoeba.

### THE REFLEX ARC

This is a description of processes, which take place within the body during a reflex action.

The stimulus is perceived by the receptors, which change it into nervous impulse (transduction). The impulse travels along the sensory neuron to the spinal cord. In the grey matter of the spinal cord, the sensory neuron makes synaptic connections to the relay neuron and impulses move from the sensory neuron to the relay neuron across synapses. The relay neuron in turn transmits the impulse to the motor neuron across a synapse. The impulse then moves from the spinal cord to the effector muscles through the motor neuron. The impulse causes the muscles to contract or relax depending on the stimulus.

### Diagram illustrating a reflex action

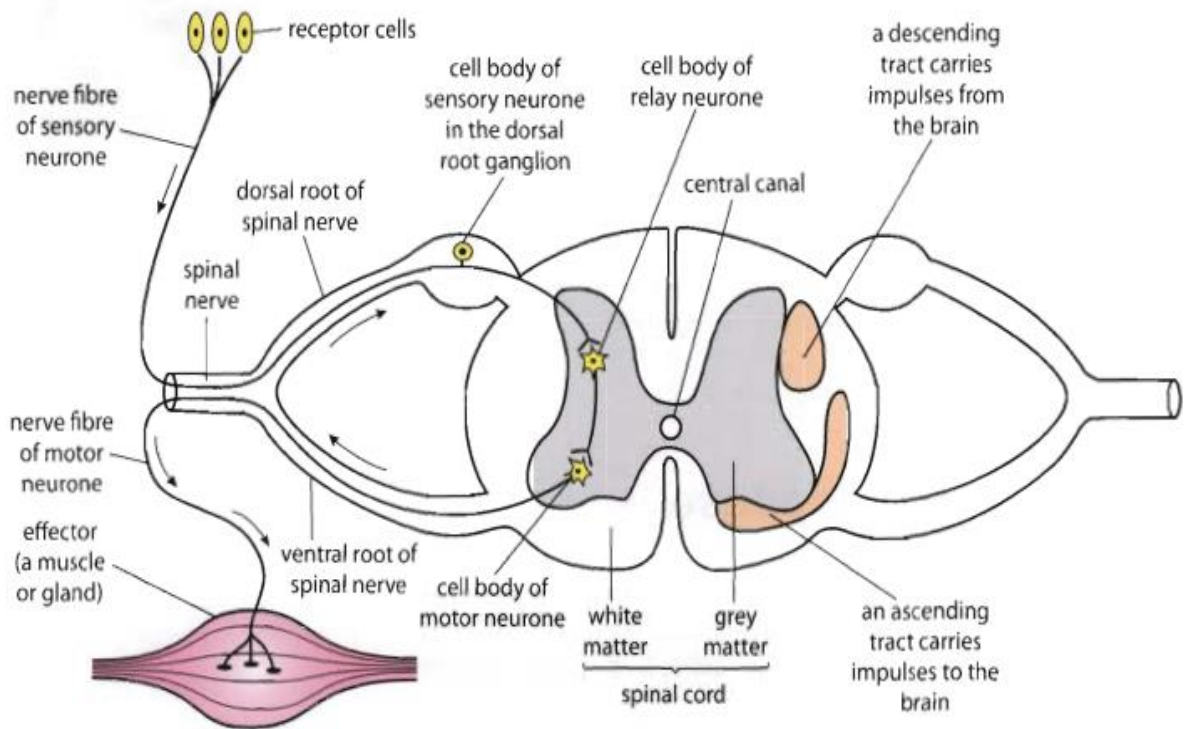

### Routes/path of reflex arc

The reflex arc has 5 paths/routes

#### 1. Receptors:

This is the organ or structure that receives the stimulus e.g. the sensory endings in the skin.

#### 2. Sensory nerve:

This is the part of the reflex arc that carries impulse from receptors to the spinal cord or to the brain.

#### 3. Relay neuron:

It connects the impulse from the sensory neuron to the motor neuron.

#### 4. Motor neuron:

This carries impulses from the relay neuron to the effectors (muscles)

#### 5. Effectors:

These are the parts of the reflex arc that carries out a response.

### Types of reflex actions

They can be grouped according to 2 ways:

#### 1) Spinal reflexes

These are reflex actions that pass through the spinal cord and are interpreted there e.g. withdrawing a hand from a hot object.

## **2) Brain/cranial reflexes**

These pass through the brain and are interpreted there e.g. closing of the eye when an object is approaching, coming of tears when one is cutting onions, etc.

## **3) Instinctive/simple reflex actions**

These are reflexes that do not require learning but are inborn e.g. suckling in human infants, making of a web by a spider, withdrawing a hand from a hot object.

### **Characteristics of simple reflexes**

- ✓ They are rapid responses
- ✓ A given stimulus brings about the same response
- ✓ They are not learnt but instinct (inborn)

### **CONDITIONED REFLEX**

This is the type of reflex which involves learning organisms learn to respond to strange (meaningless stimulus) by associating it with another meaningful/familiar stimulus, e.g. *the Ivan Pavlov's experiment*.

A scientist called Ivan Pavlov performed an experiment to demonstrate a conditioned reflex in a dog. In the experiment, he used to give the dog food at a particular time. The dog would salivate either after the smell of food or taste of food (normal response). He then started ringing a bell before giving the dog food. He did this several times. After several times, the dog salivated when a bell was rang even without food being presented (conditioned response).

For a conditioned reflex to be established, the brain is necessary thus the dog in Pavlov's experiment learnt to associate the sound of the bell with food.

When Pavlov rang the bell without food for a long time, the dog later stopped salivating implying that the conditioned reflexes are temporary.

### **Characteristics of conditioned reflex action**

- ✓ It is a temporary reflex
- ✓ It involves learning
- ✓ It takes a longer time to learn
- ✓ It is co-ordinated in the brain
- ✓ It involves more than one stimulus
- ✓ It involves association of stimulus

- ✓ It is reinforced by repetition
- ✓ Responses are involuntary

### **Similarities between simple and conditioned reflexes**

- ✓ They both involve the central nervous system particularly the brain.
- ✓ Both are autonomic responses
- ✓ Both are associated with a stimulus.
- ✓ Both involve neurons for the transmission of impulses

### **Differences between simple and conditioned reflexes**

<b>conditioned</b>	<b>simple</b>
Stimulus and responses are not directly related	Stimulus and response are related
More than one stimulus is required to cause a response	Only one stimulus is needed to cause a response
It involves learning	No learning but in born
Takes time	Takes a very short time
It is co-ordinated in the brain only	Co-ordinated in either the brain or spinal cord
Responses occur as a result of repetition and practice.	Responses occur instantly after a stimulus.

### **Similarities between reflex and voluntary actions**

- ✓ Both are co-ordinated by central nervous system.
- ✓ Both occur as a result of impulse transmission.

### **Differences between reflex actions and voluntary actions**

<b>Voluntary actions</b>	<b>Reflex actions</b>
Are not spontaneous	Occur spontaneously
Are relatively slow	Occur very fast
Are initiated by the brain	The brain does not initiate them.
They involve many neurons	They involve three neurons

## **THE ENDOCRINE SYSTEM (HORMONAL SYSTEM)**

This is a system of ductless glands that produce chemical substances called hormones. They are chemical substances that regulate body metabolic activities.

## Characteristics of hormones

- ✓ They are protein in nature
- ✓ They are produced and work best in minute quantities
- ✓ They are secreted directly into blood streams
- ✓ Their site of action is far from where they are produced
- ✓ The site of action is called the target organ
- ✓ They are produced by endocrine glands
- ✓ Their effect on the target organ is either by stimulation or inhibition i.e. they regulate the activities of the target organs.

## GLANDS

These are tissues or organs that produce and secrete chemical substances. There are 2 types of glands i.e. *endocrine and exocrine*.

### EXOCRINE GLANDS

These are glands that secrete their substances to their target organ through their ducts i.e. these glands have ducts that connect and carry their chemical substances to their target organs hence they are called **duct glands**.

#### Examples:

- 1) Pancrease releases pancreatic juice.
- 2) Salivary gland has salivary duct that carries saliva into the mouth cavity.
- 3) Sweat glands
- 4) Tear glands

### ENDOCRINE GLANDS

These are ductless glands that secrete their hormones directly into the blood stream. The blood carries the hormones from the glands to their target organs hence endocrine glands are called ductless because they have no ducts e.g. pituitary gland, thyroid gland, pancrease, etc.

### Location of endocrine glands

Endocrine glands are situated in the head, neck, and trunk as shown in the diagram below.

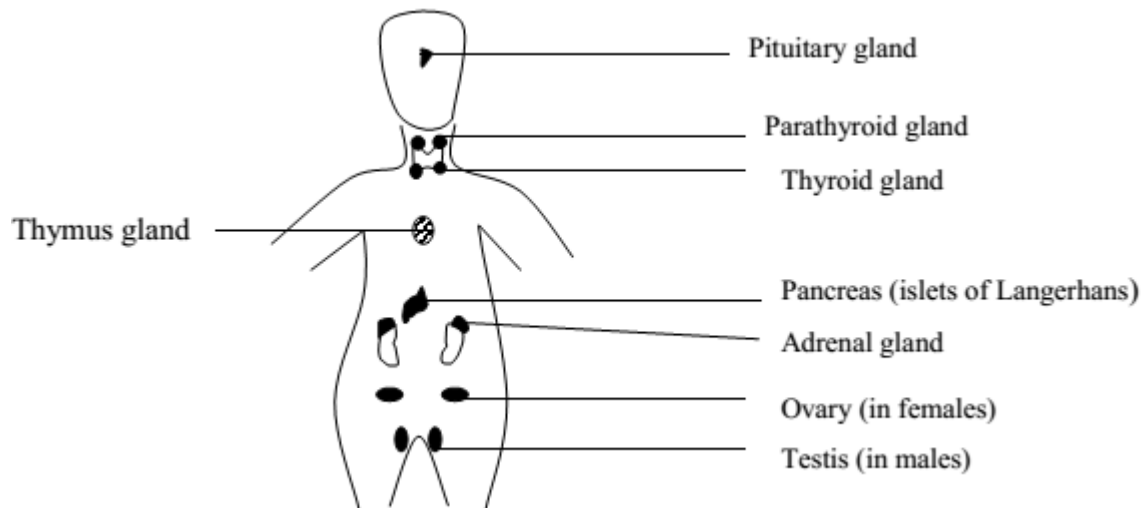

## **HORMONES OF THE ENDOCRINE GLANDS AND THEIR FUNCTIONS**

### **1. PITUITARY GLAND**

This is an outgrowth at the base of the brain. The pituitary gland releases several hormones most of which stimulate the production of other hormones from other endocrine glands. Because of this it controls other endocrine glands and it is referred to as the master gland.

#### **The pituitary as a master gland:**

The pituitary gland acts as a master gland because it produces several hormones most of which stimulate other endocrine glands to produce their hormones. Because of this, the pituitary controls other endocrine glands.

#### **Hormones produced by the pituitary gland.**

- 1) It produces antidiuretic hormone (ADH), which controls the amount of water and salts reabsorbed into the blood stream by the kidneys.
- 2) It produces follicle-stimulating hormone (FSH), which causes the development of graafian follicles in the ovary.
- 3) It produces thyroid-stimulating hormone (TSH), which stimulates the thyroid gland to secrete thyroxin.
- 4) It produces adrenal cortical stimulating hormone (ACSH), which stimulates the adrenal gland to produce a hormone called cortisone.

- 5) It produces interstitial cell stimulating hormone (ICSH), which stimulates the testes to produce their hormone called testosterone.
- 6) It produces a growth hormone, which controls the growth of bones and other tissues. Over secretion of growth hormone causes ***gigantism***. Under secretion of growth hormone causes ***dwarfism***.
- 7) It produces luteinizing hormone (LH), which causes ovulation.
- 8) Prolactin which stimulates milk production in pregnant females.
- 9) Oxytocin which causes the contraction of uterus thus inducing birth. It also stimulates milk flow from the mammary gland.

## **2. THE THYROID GLAND.**

This produces a hormone known as **thyroxin**, which in young organisms controls growth and development for example in tadpoles it brings about metamorphosis.

In adults thyroxin controls the rate of respiration.

In adults too little thyroxin leads to overweight and sluggishness and too much of it causes thinness and over activity.

Deficiency of thyroxin in infancy cause a type of mental deficiency known as **cretinism** which can be cured if identified early by administering thyroxin in the body.

Thyroxin is made up of an amino acid containing iodine. Lack of iodine causes the thyroid gland to increase in size as a way of producing more thyroxin. This leads to a disease known as **goiter**.

## **3. ADRENAL GLAND.**

There are two adrenal glands situated above each kidney. The gland is made up of two parts.

**a) Cortex;** this is the outer part of the adrenal gland.

**b) Medulla;** this is the inner part of the adrenal gland.

The adrenal cortex produces several hormones including a hormone known as **cortisone**, which is responsible for conversion of proteins to glucose. The adrenal gland is stimulated by the adrenal cortical stimulating hormone produced by the pituitary to produce cortisone.

The adrenal medulla is stimulated by nervous impulses to produce a hormone known as **adrenaline**. Adrenaline is produced when the animal feels frightened or excited. Adrenaline brings about the following changes in the body.

- i) It increases the rate of heartbeat.
- ii) It increases the breathing rate.

- iii) It widens the pupils of the eyes.
- iv) It brings about conversion of glycogen to glucose in the liver.
- v) It brings about the growth of goose pimples on the body.
- vi) It increases the rate of respiration in order to ensure adequate supply of energy to body muscles.

Due to the abundance of energy, there is increased muscle contraction making the animal to feel stronger. This hormone prepares the animal to fly or run away or to fight with another. This hormone is therefore known as a “**flight or fight**” hormone.

#### **4. THE PANCREAS.**

In addition to production of digestive enzymes, the pancreas produces two hormones known as *insulin* and *glucagon*. These hormones are produced from groups of cells in the pancreas known as *islets of estrogen*.

Insulin is produced from the  $\beta$ - islets of estrogen. *Insulin stimulates the liver to convert excess glucose into glycogen for storage*. If the pancreas produces little or no insulin, the amount of sugar increases in blood resulting into a disease called **diabetes mellitus**. The disease is controlled by continuous injection of insulin in the body.

Glucagon is produced from the  $\alpha$ - islets of estrogen in the pancreas. When released in blood, *glucagon moves to the liver and stimulates the liver to convert glycogen to glucose*.

#### **5. THE DUODENUM.**

The presence of food in the duodenum stimulates the lining to produce a hormone called **secretin**. Secretin moves in blood to the pancreas and stimulates it to produce pancreatic digestive enzymes. This ensures that the enzymes are produced when food is present.

#### **6. THE REPRODUCTIVE ORGANS (TESTES AND OVARIES)**

The ovary in females produces two major hormones. These are **estrogen** and **progesterone**.

Oestrogen controls secondary sexual characteristics in females such as;

- i) Development of breasts.
- ii) Growth of pubic hairs.
- iii) Widening of hips.
- iv) Enlargement of reproductive organs.
- v) Softening of muscles.
- vi) Softening of the voice.

Oestrogen also causes repair of the uterine lining after menstruation.

**Progesterone** is responsible for maintaining the endometrium prior to implantation.

In males the testes produce a hormone known as **testosterone**. This hormone brings about male sex characteristics, which include;

- i) Deepening of the voice.
- ii) Growth of beards.
- iii) Toughening of muscles.
- iv) Widening of the chest.
- v) Enlargement of reproductive organs.
- vi) Growth of pubic hairs.
- vii) Sperm production.

## 7. PARATHYROID GLAND

It secretes parathormone which has the following functions:

- ✓ Controls the distribution of calcium and phosphorus in the body.
- ✓ It affects development of bones.

## 8. THYMUS GLAND

This gland is close to the heart and well developed in young mammal but greatly reduced in adults.

It provides defense (immunity) in young mammals.

### **Similarities between the nervous and endocrine system**

- ✓ Both are affected by change in stimulus
- ✓ Both cause a response
- ✓ They provide a means of co-ordination in the body
- ✓ In nature, the messages transmitted are chemical
- ✓ Both systems transmit messages.

<b>Nervous system</b>	<b>Endocrine system</b>
Nerve impulses are electrical	Impulses are chemical
Responses are fast as the impulses are carried fast.	Responses are slow but long lasting
Impulses go along nerve fibres	Hormones are carried in blood
This effect is more localized (specific)	Effect is wide spread in the whole body
Stimulus arises from any part of the	Stimulus arises from specific places

body where sensory receptors are localized.	only e.g. endocrine glands.
---	-----------------------------

## **DISEASES OF THE NEURO-ENDOCRINE SYSTEM**

### **1. Poliomyelitis**

It can kill or cripple people. It is caused by a virus which affects the motor nerve cells in the central nervous system. It enters the body through breathing or eating contaminated food.

### **2. Tetanus**

It is caused by bacteria which enter the body through open cuts on the skin. It damages the nervous system causing the muscles of the skin to become stiff and the jaws immovable.

### **3. Meningitis**

It is caused by bacteria that attack the cerebro spinal fluid.

### **4. Leprosy**

It's caused by bacteria that enter the body through skin contact and mucus.

### **5. Cerebral malaria**

It's caused by malarial parasites i.e. plasmodia

### **6. Epilepsy**

A patient loses consciousness suddenly and quickly. It is inherited

## **SENSE ORGANS OR RECEPTOR ORGANS IN MAMMALS**

These are organs that perceive the stimulus and change it into nervous impulse (transduction).

Receptor organs are made up of cells called receptor cells. There are different types of receptor cells depending on the nature of the stimulus they perceive and the organ in which they are contained.

### **Receptor organs and their functions**

<b>Receptor cell</b>	<b>Nature of stimulus</b>	<b>Receptor organs</b>	<b>Function</b>
Photoreceptors	Light	Eye	Vision
Mechanoreceptors	Sound and gravity	Ear	Hearing and balancing

Chemo receptors	Chemicals	Nose	Smelling
Thermo receptors	Temperature	Skin	Detecting temperature
Chemo receptors	Chemicals	Tongue	Tasting
Mechanoreceptors	Pressure	Skin	Detecting pressure changes.

### **THE MAMMALIAN EYE**

The mammalian eye is a receptor organ responsible for sight. It contains photoreceptor cells, which perceive the light stimulus and change it into nervous impulse.

#### **Structure of the mammalian eye**

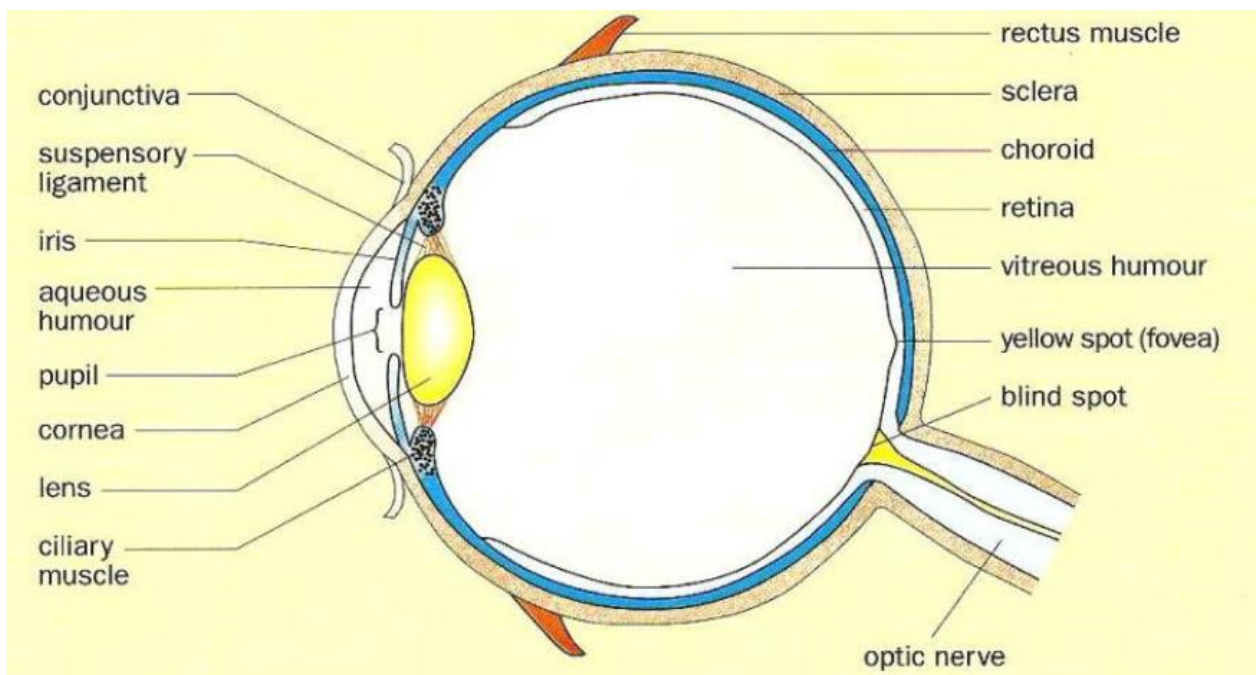
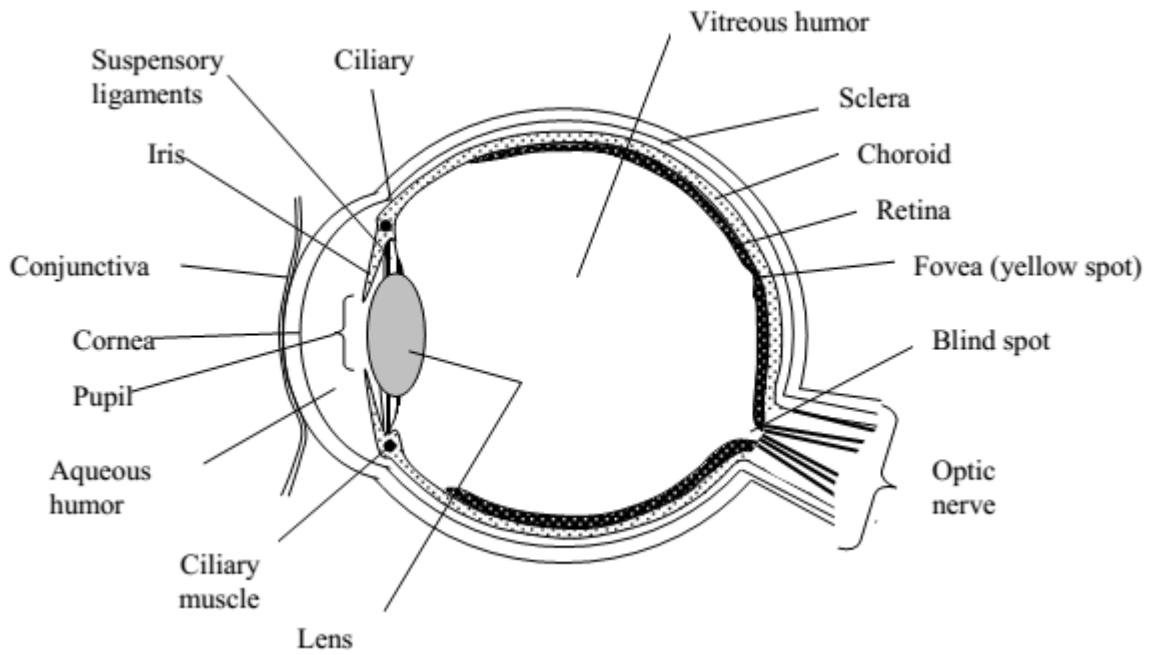

## Parts of the eye

### 1. The conjunctiva:

This is a thin transparent layer lining the inside of the eyelid.

It protects the eye and holds it in position.

It enables the eye ball to move easily by secreting mucus.

**2. The sclera:**

This is a tough inelastic layer that gives shape to the eye.

It protects the inner most delicate parts.

It provides attachment for the muscles of the eye.

**3. The cornea:**

This is a transparent layer in front of the eye.

It refracts (bends) light into the eye.

**4. The choroid layer:**

It is below the sclerotic layer.

It is pigmented and mainly contains black pigment which stops reflection of light rays.

It prevents internal reflection of light.

This contains a network of blood vessels supplying oxygen and food to the eye.

**5. The aqueous humour:**

It is a solution of sugar, salts and proteins.

The aqueous humor is a watery fluid which maintains the shape of the eye.

It also refracts light into the pupil and the lens.

**6. The vitreous humuor:**

It is a jelly-like substance that fills the inner cavity of the eye.

It is transparent and maintains the shape of the eye.

It refracts light to the retina.

**7. The ciliary body:**

This contains ciliary muscles, which control the size of the lens during viewing nearby or distant objects.

**8. The lens.**

It is transparent and held by suspensory ligaments.

It refracts light to make an image on the retina.

## **9. The iris**

This is made up of an opaque tissue the center of which is a hole called pupil that allows in light to form an image on the retina.

The contraction of the muscles of the iris increases the size of the pupil and relaxation decreases the size of the pupil.

It is therefore responsible for controlling the amount of light entering the eye.

## **10.The retina**

This is a layer containing photoreceptor cells (light sensitive cells)

There are two types of light sensitive cells on the retina

- i) Rods
- ii) Cones

*The cones* are sensitive to coloured light and are responsible for colour vision. They are also sensitive to light of high intensity and are used during daytime.

Most cones on the retina are concentrated on the fovea or yellow spot.

*The rods* are incapable of perceiving coloured light and are sensitive to light of low intensity (dim light). They are used during night vision.

Nerve fibers from the photoreceptor cells run to the brain via the optic nerve.

The rods contain a pigment rhodopsin which is rapidly bleached by even a small amount of light but at the same time it is rapidly generated.

The cones contain a pigment called iodopsin which is less sensitive to light and is not bleached so quickly.

The retinas of nocturnal animals have mainly rods. Due to this, nocturnals can't perceive different colours.

*Therefore the retina is where the image is formed in the eye.*

## **11.Pupil.**

This is a round black hole in the center of the eye lying behind the cornea. It allows light to pass into the eye to the lens.

## **12.Suspensory ligaments.**

These are inelastic fibers that hold the lens in position.

## **13.The blind spot:**

This is a region where the nerve fibers leave the eye to enter the optic nerve. It has no light sensitive cells. When an image falls on this point, it is not taken to the brain thus blind spot.

#### **14.The fovea**

This is a small depression in the center of the retina. It has only cones in a high concentration. It is therefore a region on the retina that contains the largest number of sensory cells. Due to this, it produces the most accurate images in the eye.

#### **15.Eye lids**

These protect the eye and remove any foreign bodies that enter it. Regular blinking enables the spread of the fluid all over the exposed surface of the eye.

#### **16.Eye lashes**

They prevent dust particles and other objects from entering the eye.

### **IMAGE FORMATION AND VISION**

Light from an external object enters the eye. It is refracted by the cornea into the aqueous humour. The aqueous humour then refracts it to the lens. The lens refracts it to the vitreous humour. The vitreous humour finally refracts light and focuses it to the retina making an image on the retina. The photoreceptors in the retina change the light stimulus into a nervous impulse. The impulse travels along the optic nerve to the brain where interpretation of the image is made. The image formed on the retina is smaller to the real object and it is *upside down*.

#### **Illustration**

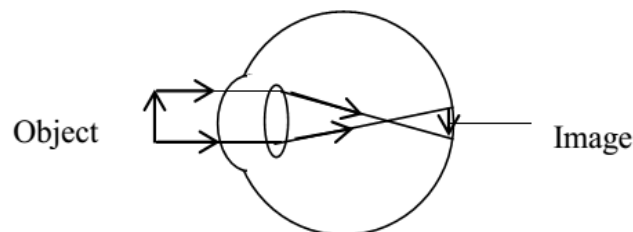

### **CONTROL OF LIGHT AMOUNT ENTERING THE EYE**

The iris controls the amount of light entering the eye. It is made up of circular and radial muscles.

When the circular muscles of the iris contract, the size of the pupil is reduced and less light is allowed in.

Contraction of the radial muscles widens the pupil so allowing more light to enter the eye.

In light of low intensity, the pupil widens and in bright light, the pupil reduces in size. This is done to protect the retina from damage by bright light and the wide size of the pupil during dim light allows in enough light of low intensity.

### **Control of the amount of light rays entering the eye when in dim light:**

In dim light, radial muscles contract,

Circular muscles relax,

Pupil widens and more light is admitted into the eye.

#### **Dim light:**

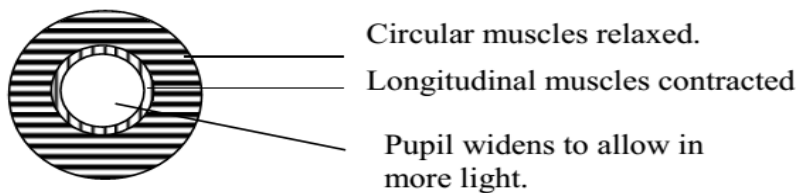

### **Control of amount of light rays entering the eye in bright light:**

Circular muscles of the iris contract,

Radial muscles relax,

Pupil becomes smaller and narrower,

Less light is admitted into the eye.

#### **Bright light:**

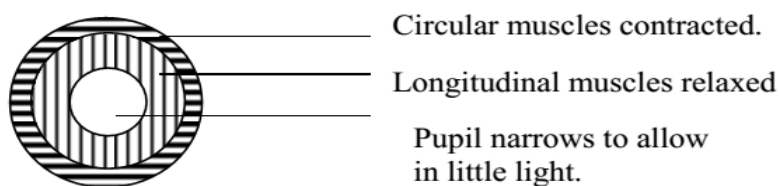

## **ACCOMMODATION OF THE EYE**

This is the ability of the eye to change the focal length of the lens when viewing distant or nearby objects.

### **Accommodation for a nearby object:**

When looking at a nearby object, the ciliary muscles in the ciliary body contract, the suspensory ligaments slacken. This makes the lens short and thick.

This increases the ability of the lens to refract light and reduces the focal length of the lens for the nearby object to be seen clearly.

**Illustration**

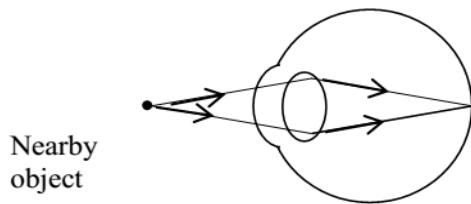

**Accommodation for a distant object:**

When viewing a distant object, the ciliary muscles in the ciliary body relax. This causes tension in the suspensory ligaments. The suspensory ligaments pull the lens apart making the lens thin and long. This makes the lens to refract less and increase the focal length of the lens.

**Illustration**

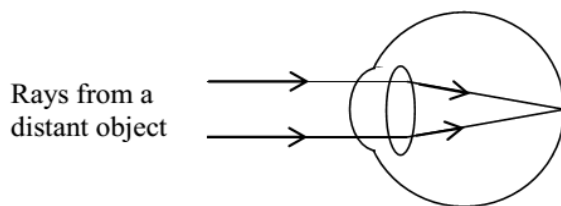

**Summary of accommodation**

Nearby object	Distant object
Diverging light rays from a nearby object are refracted by cornea.	Parallel light rays from a distant object are refracted by the cornea.
Cilliary muscles in the cilliary body contract.	Cilliary muscles in the cilliary body relax.
Suspensory ligament slacken	Suspensory ligaments develop tension
The lens become short and thick	The lens becomes thin and long
The focal length of the lens decreases	The focal length of the lens increases.
Light rays are refracted to the retina	Light rays are refracted to the retina.

## EYE DEFECTS

An eye defect is a condition where the eye fails to focus an object well unless aided by external lenses.

The common eye defects include:

### 1. Short sightedness (myopia):

This is usually caused by a large eyeball or a very strong lens. Light from a distant object is focused in front of the retina. The individual can only see nearby objects but not distant ones.

#### Illustration

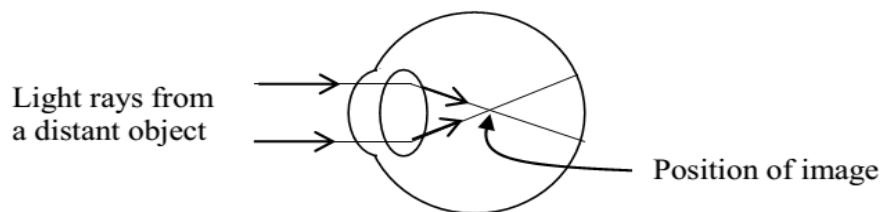

This can be corrected by putting on diverging (concave) lenses.

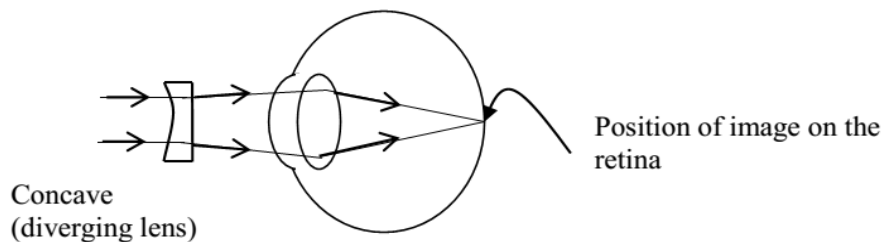

### 2. Long sightedness (hypermetropia):

This is caused by a small or short eyeball or a very weak lens such that a close object is focused far behind the retina. The individual can see distant objects but cannot see nearby objects.

#### Illustration

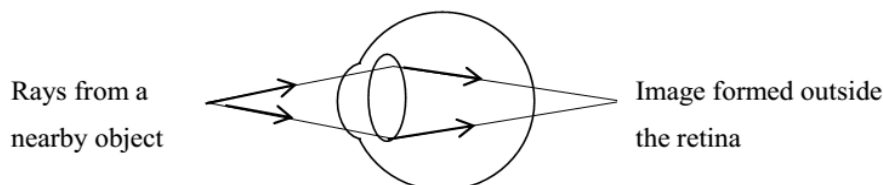

Long sightedness can be corrected by wearing converging (convex) lenses.

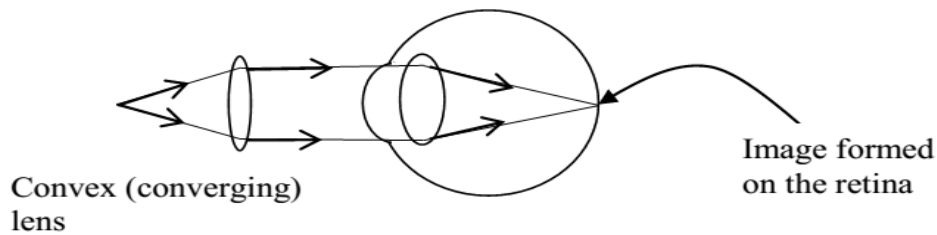

### 3. Astigmatism

This is caused by unequal refraction of the cornea and lens due to uneven curving in them. It results into some parts of the object being well focused on the retina and some not to be focused. It is normally due to old age. This can be solved by wearing cylindrical lenses.

### 4. Presbyopia

This condition occurs when the lens hardens due to old age and does not focus. It can be corrected by wearing spectacles with convex lenses or often 2 pairs of spots may be necessary i.e. a pair with convex lenses for close vision and a pair of concave lenses for distant vision or the 2 types of lenses can be combined into one pair known as bi-focal spectacles.

### 5. Cataract

It is a condition which occurs when an individual is aging. It is caused by the eye lens becoming opaque due to a thin covering formed on it. It is corrected by surgical removal of the thin opaque layer of the lens.

Other eye defects include trachoma, conjunctivitis, colour blindness and glaucoma.

### Colour vision

The cones are photoreceptor cells on the retina, which are concerned with colour vision. There are three types of cones, which are sensitive to three primary colours i.e. the blue sensitive cone, green sensitive cone and red sensitive cone. When blue sensitive cones alone are stimulated, blue colour is perceived. Stimulation of green alone gives green colour. Stimulation of red cones produces red colour. Equal stimulation of both green and red gives yellow colour. Equal stimulation of the entire three gives white colour and when no cone is stimulated, no colour (black) is perceived. This is known as the **trichromatic theory**.

## THE EAR

### Structure of the ear

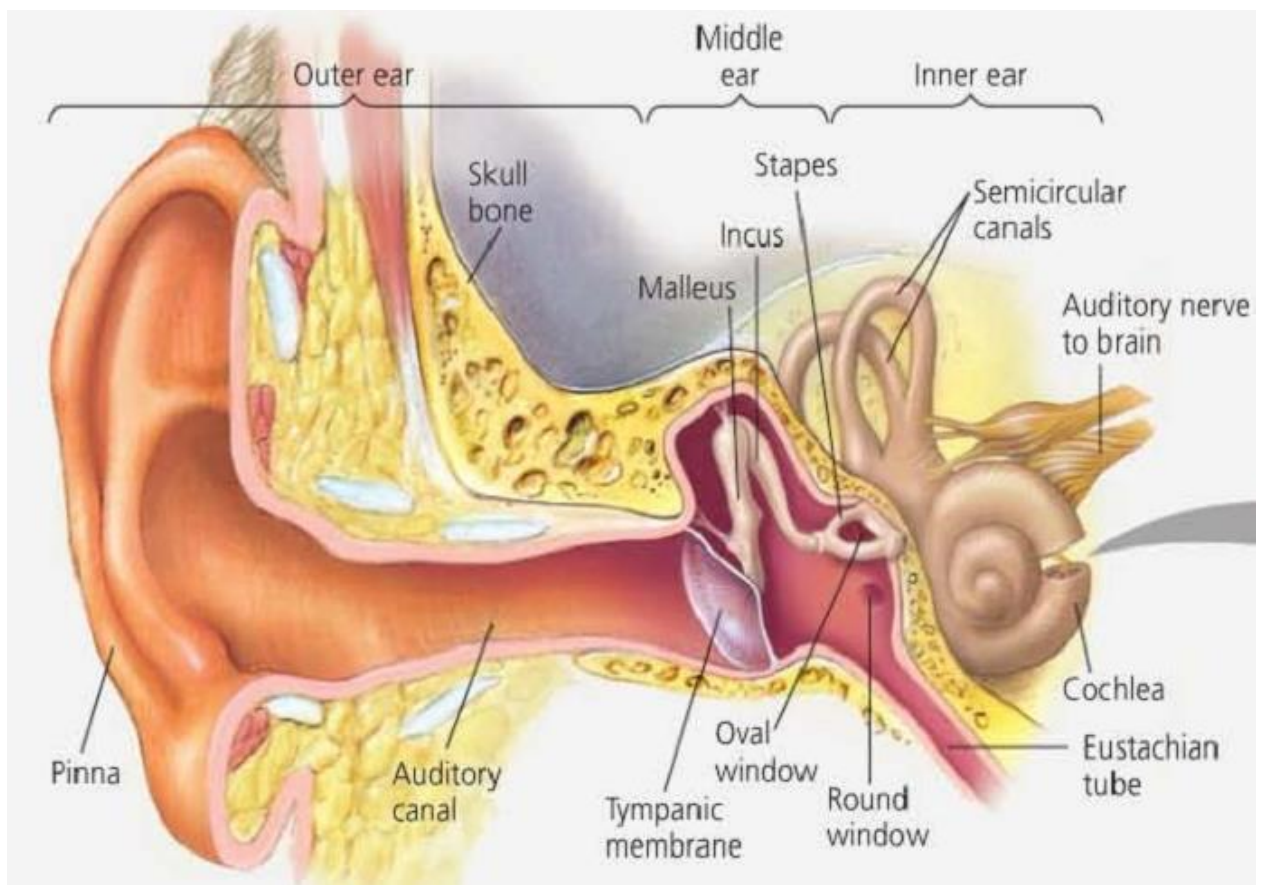
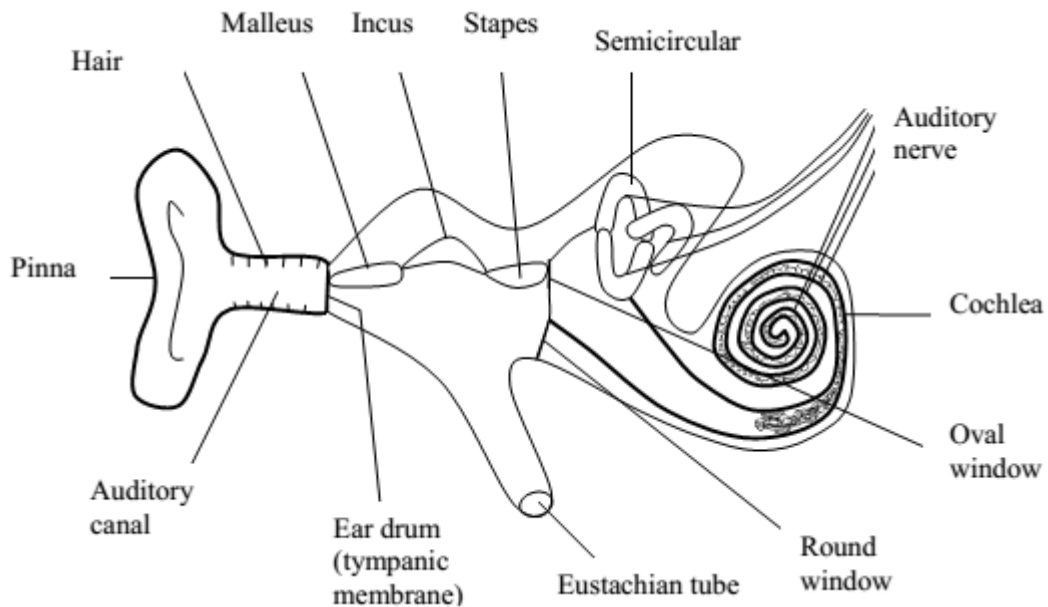

The ear has sensory receptors for hearing and balancing. These are mechano-receptors because they respond to pressure and gravity. The ear is made up of three areas i.e. the outer ear, middle ear and inner ear.

### **1. The outer ear:**

This is the tube opening to the side of the head and inwards stopping at the eardrum. It has an outer extension called the pinna. The pinna concentrates and directs the sound vibrations into the ear through the auditory canal. This makes the ear drum to vibrate.

### **2. The middle ear:**

This is a cavity in the skull filled with air. It communicates with the mouth cavity through the Eustachian tube. There are three small bones called ossicles in the middle ear which link the eardrum and the opening of the skull called oval window that leads to the inner ear.

### **3. The inner ear:**

The inner ear is filled with a fluid and consists of mainly a coiled tube known as the cochlea. The cochlea has sensory nerve endings leading to the brain. These transmit nervous impulses from the ear to the brain.

## **Functions of parts of the ear**

### **1. Pinna:**

### **2. Ear ossicles:**

These are 3 tiny bones in the middle ear. They are:

- ✓ Malleus (hammer)
- ✓ Incus (anvil)
- ✓ Stapes (stirrup)

They are joined like a chain and they transmit sound vibrations across the middle ear from the ear drum to the oval window. They amplify sounds of low tones.

### **3. Eustachian tube:**

It connects the middle ear to the pharynx of the mouth.

Its function is to equalize air pressure on both sides of the ear drum so that it can vibrate freely.

It opens when one is swallowing and yawning.

It prevents the eardrum from bulging.

The Eustachian tube is used to balance the pressure inside the ear with that outside the ear.

When the pressure of air in the middle ear is higher than that of the atmosphere, yawning takes place and air escapes from the middle ear through the Eustachian tube to the mouth where it is lost. This reduces the pressure back to normal.

When the pressure of air in the middle ear is lower than that of the atmosphere, yawning takes place to allow the atmospheric air to go into the middle ear through the mouth and Eustachian tube. This raises the pressure back to normal.

#### **4. Oval window (fenestra ovalis):**

It is a flexible membrane which vibrates and sets up vibrations in the fluids of the ear called perilymph in the cochlea.

It receives impulses from the steps and transmits them to the cochlea.

#### **5. Round window (fenestra rotunda):**

It is a flexible membrane which controls the displacement in the cochlea created by vibrations of ossicles by releasing pressure when it bulges out wards.

### **Structure of the semi-circular canals and cochlea**

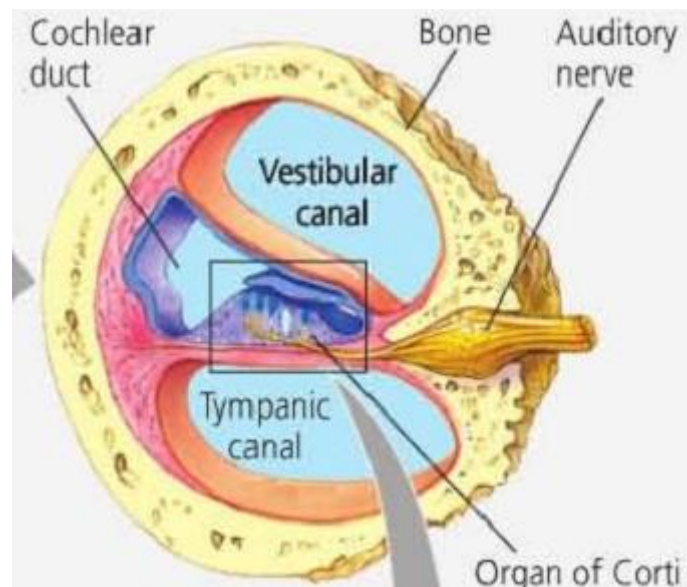

#### **6. Cochlea:**

It is a 3 chambered fluid filled tube which is coiled. It contains sensory cells which pick up vibrations in the fluid and transmit them to the auditory nerve.

The sound vibrations move along the auditory nerve and reach the brain where they are interpreted as sound. Its 3 chambers include:

- i) **Vestibular canal (scala vestibuli)**

It is the upper canal which starts from the oval window. It contains perilymph.

**ii) Tympani canal (scala tympani)**

It is the lower canal which ends in a smaller membrane called the round window. It also contains perilymph.

**iii) Middle canal (scala media)**

It is located between the vestibular and tympanic canal. It is filled with a fluid called endolymph. It contains sensory cells which detect sound. These cells form the hearing apparatus called the organ of corti. The organ of corti is connected to the auditory nerve.

### **Cross section of a cochlea**

#### **7. Semi-circular canal (organ of balance):**

These are 3 semicircular canals which are at right angles to each other. They contain a fluid called endolymph. At one end of the canal, there is a swelling called ampulla. It contains sensory cells.

When the person moves the head or whole body, the endolymph, in the semi-circular canals moves in the opposite direction. The moving fluid strikes the sensory hair cells which are stimulated and sends impulses to the brain.

The 3 semicircular canals give information about the direction of movement of the body e.g. if a person spins around in one direction and then stops suddenly, the fluid continues to flow around the sensory hair cells. This gives a sensation of the ground spin around of the group spinning in the opposite direction.

### **Section through the ampulla**

### **The process of hearing**

Sound waves are collected and concentrated into the ear by the pinna.

They are then directed to the tympanic membrane (ear drum) through the auditory canal.

This causes the eardrum to vibrate.

The vibrations of the eardrum are amplified and transmitted by three ossicles starting from the malleus, incus and finally the stapes hands them over the oval window that leads to the inner ear.

Vibrations in the oval window make the fluid in the inner ear and cochlea to vibrate.

Receptors in the cochlea (organ of corti) receive the information, change it into impulses and the impulses are taken to the brain via the auditory nerve.

### **The process of balancing**

The semi-circular canals, utriculus and sacculus in the inner ear are all concerned with the sense of balance and positioning.

The three semi-circular canals are filled with a fluid and each lies in a different plane.

One is horizontal and two are vertical but at right angles to each other.

At the end of each semi-circular canal is a swelling known as the ampulla, which contains sensory cells.

Within the ampulla is a structure covered by sensory cells with hairs on their upper surfaces. The hairs are embedded in a corner of jelly known as cupulla.

The semicircular canals are stimulated by rotation of the head and body in their respective planes.

The utriculus and sacculus have gelatinous plates in their fluid filled cavities, which contain granules called otoliths.

The otoliths are attached to sensory fibres. When the head is tilted, the otoliths pull on the sensory fibres. This causes an impulse to be fired off from these organs to the brain. A reflex is then set off which causes the body to return to its normal posture.

**Note:**

The utricle responds to vertical movement of the head while the saccule responds to lateral movement of the head.

### **Internal structure of the semicircular canal**

#### **Common ear disorders**

##### **1. Ear ache and ear discharge:**

It is usually due to an inflammation in the middle ear.

It occurs when microorganisms reach the middle ear via the Eustachian tube. Due to severe inflammation, pus may be formed in the middle ear and the eardrum become perforated. The discharge may lead to permanent deafness.

##### **2. Deafness:**

This is caused by accumulation and hardening of wax in the outer auditory canal which presses against the eardrum.

Blocking of the Eustachian tube, exposure to loud noise over a long period of time can damage the organ of Corti leading to deafness.

Also damage to the cochlea or the hearing centre of the brain can also cause deafness.

### **THE TONGUE**

The tongue is the receptor organ for the sense of taste. It changes chemicals in the mouth into nervous impulses. It contains chemo-receptors, which carry out this function. The tongue contains taste buds, which contain the chemo-receptor cells. The tongue distinguishes between four different kinds of tastes, i.e. *sweet, sour, salt and bitter*.

The taste buds for the different tastes are located in different parts of the tongue as shown in the diagram below.

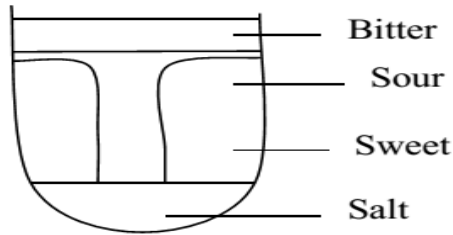

When a chemical is placed in the mouth, it dissolves in the moisture (saliva) in the buccal cavity. The dissolved chemicals then stimulate the taste buds in the different parts of the tongue depending on the type of taste. Impulses are then sent from the tongue through a sensory neuron to the brain and the brain interprets the type of taste.

### **THE NOSE**

The nose is the receptor organ for smell. It is also made up of chemo-receptor cells and it is stimulated by chemicals in air. This helps the organism to respond to chemical stimuli at a distance. When air containing a chemical enters the nose, it dissolves in the moisture (mucus) in the nasal cavity. In this form, it stimulates the chemo-receptor cells in the nose. These cells send nervous impulses through a sensory neuron to the olfactory lobe of the brain where interpretation occurs.

### **THE SKIN**

The skin is a sense organ responsible for the senses of pain, touch, pressure and temperature. The structure and excretory role of the skin has been discussed under **EXCRETION AND OSMOREGULATION**.

## **GROWTH AND DEVELOPMENT**

**Growth** is defined as an irreversible or permanent increase in the size and dry weight of an organism. Growth in multicellular organisms is divided into 3 phases.

### **1. Cell division**

This involves increase in the number of cells mainly as a result of mitosis.

### **2. Cell expansion**

This is the permanent increase in the cell size as a result of uptake of water or synthesis of living materials.

### **3. Cell differentiation**

This involves specialization of cells to suit particular functions. Growth is usually accompanied by an increase in the complexity of an organism which is also called **development**.

**Development** is the increase in complexity and change of form of an organism.

## **FACTORS AFFECTING GROWTH**

### **A. External factors**

#### **i) Nutrients**

Growth of an organism increases in the availability of nutrients and decreases when nutrients are in short supply. This is because nutrients are used in the building up of new protoplasm and organic matter. Also nutrients can be oxidized to provide energy required for growth. Therefore lack of nutrients can lead to decrease in growth or even death.

#### **ii) Accumulation of the byproducts of metabolism (excretory substances):**

Growth may be inhibited by metabolic waste products which are toxic to the body cells. Fortunately most plants and animals are not affected much because they can convert these substances to less toxic excretions.

#### **iii) Temperature:**

Growth depends on bio-chemical reactions which are catalyzed by enzymes. Temperature affects growth by affecting enzymes which catalyze the chemical reactions in the body. Increase in temperature to the optimum increases the rate of growth, beyond which retardation of growth occurs.

#### **iv) Light:**

In plants, light affects growth by affecting the rate of photosynthesis which adds more organic matter to the plant. Therefore increase in light intensity in green plants increases the rate of growth and decrease in light intensity decreases the rate of growth.

#### **v) PH:**

The PH affects the activity of enzymes which catalyzes reactions in the body. This can result into decrease in growth of an organism.

**vi) Carbon dioxide:**

In animals, carbon dioxide is a waste product of metabolism. If allowed to accumulate, it can lead to a decrease in the rate of growth while in plants carbon dioxide is a raw material for photosynthesis therefore increase in carbon dioxide concentration increases the rate of growth.

**B. Internal factors**

**i) Hormones:**

In animals, the presence of growth hormones and thyroxin in blood increases the rate of growth while in plants the presence of auxins also increases the rate of growth.

**ii) Hereditary factors:**

Growth is under the control of genes which determines the particular size of an organism.

**GROWTH AND DEVELOPMENT IN PLANTS**

In plants, growth is continuous processes which occurs mainly at the tips of the root and shoot systems. These regions are called **meristems**. *A meristem is a group of undifferentiated plant cells which are capable of dividing repeatedly by mitosis.*

**Types of meristems**

**i) Apical meristems**

They are located at the tip of roots and shoot. They bring about increase in length or height of the plant. This type of growth which involves increase in length or height of a plant is known as **primary growth**.

**ii) Lateral meristems**

These are laterally situated in the stems and roots of the dicot plants. It brings about **secondary growth** after primary growth. Secondary growth (secondary thickening) involves increase in girth/thickness in a plant.

**Lateral meristems are of 2 types namely:**

- a) Cork cambium; which forms the secondary cortex
- b) Vascular cambium; which gives rise to the secondary phloem and xylem tissues.

## **SEED GERMINATION**

*This is defined as the emergence and development of an embryo into a seedling capable of existing as a new and independent plant under favorable conditions.*

### **The process of germination**

During germination, a seed absorbs water from the soil by imbibition mainly through the micropyle which makes the cotyledons swell and split the testa. The water enables the enzymes in the cotyledons to hydrolyze the stored food into soluble products which are later used by the germinating seed.

The enzymes involved in hydrolysis include diastase, protease and lipase. The soluble food substances diffuse into the cell where it is required for the growing embryo. Simple sugars and fats are oxidized to produce energy. Amino acids are used to make protoplasm of new cells. Absorption of water from the soil results into increase in the size of the seed and growth of the radicles and plumule which brings about rupturing of the seed coat and an embryo emerges.

## **TYPES OF GERMINATION**

### **1. Epigeal germination:**

In this type of germination, the *cotyledons appear above the ground due to the rapid elongation of the hypocotyl* (i.e. the portion of the stem below the cotyledons) e.g. in tomatoes, beans, cotton, lettuce.

*During epigeal germination* the seed absorbs water through the micropyle in a process called imbibition. This softens the testa and makes the cotyledons to swell. The testa splits to allow the radicle and plumule to emerge. The water hydrolyses the stored food reserves and the products are passed from the cotyledons to the radicle and plumule where they are used for growth. The

radicle emerges first and the hypocotyls start to elongate pushing the cotyledons upwards. The cotyledons may turn green in some plants and can carry out photosynthesis. The cotyledons open to allow out the plumule. The leaves are formed and they start to photosynthesize.

### Diagrammatic illustration of epigeal germination

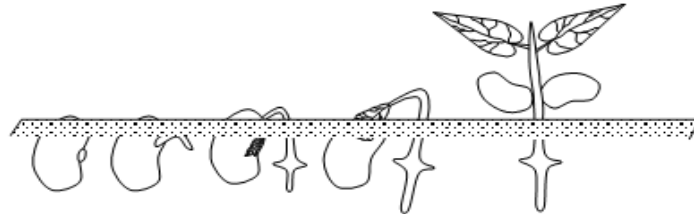

### 2. Hypogeal germination:

In this type of germination, the *cotyledon remains below the ground due to the rapid elongation of the epicotyl* (i.e. the portion of the stem above the cotyledons) e.g. in broad bean, peas and maize.

*During hypogeal germination*, the seed absorbs water by imbibition. The radicle appears first bursting its protective sheath called coleorhizae. The radicle produces fibrous roots, which absorb water and anchor the plant. The protective plumule sheath (coleoptiles) opens to allow the plumule out. The epicotyls elongate pushing the cotyledons below the ground.

### Diagrammatic illustration of hypogeal germination

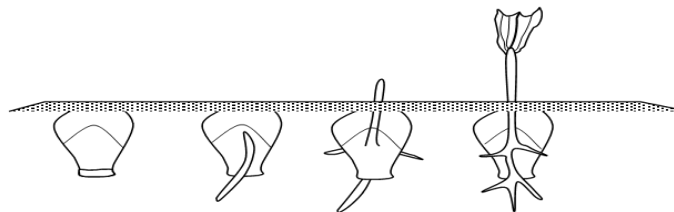

### Conditions necessary for seed germination

#### 4. Water

Water is needed for the following:

- It activates the enzymes within the seed to hydrolyze the stored food.
- It makes the seed swell, soft and the testa to bursts.
- It dissolves the stored food.
- It is a medium in which all the chemical and enzymatic reactions proceed.

- It is a medium of transport of the dissolved food substances to the developing shoot and root of the new plant.
- Water is needed for the development of cell vacuoles. Large cell vacuoles contribute to increase in size of cells.

### **5. Oxygen**

Oxygen is necessary for the process of respiration, the oxidation of food to provide energy required for growth.

### **6. Warmth**

Suitable temperature is important for the enzyme controlled reactions in the cotyledon of the germinating seed. At low temperatures, the enzymes are inactive and at high temperatures, they are denatured hence no germination. Germination will require an optimum temperature which varies from 10°C-50°C for most tropical seeds.

## **EXPERIMENTS ON GERMINATION**

### **An experiment to demonstrate the conditions necessary for germination**

#### **Apparatus:**

4 test tubes, Cotton wool, Seeds, Oil and Water.

#### **Procedure:**

- f) Arrange four test tubes labeled 1-4
- g) To test tube 1 add moist cotton wool, seeds and leave test tube open.
- h) To test tube 2 add dry cotton wool, seeds and leave test tube open.
- i) To test tube 3 add seeds, boiled cooled water and a layer of oil.
- j) To 4 add seeds, moist cotton wool, ice and leave test tube open. Leave all test tubes for 3 days.

#### **Setup:**

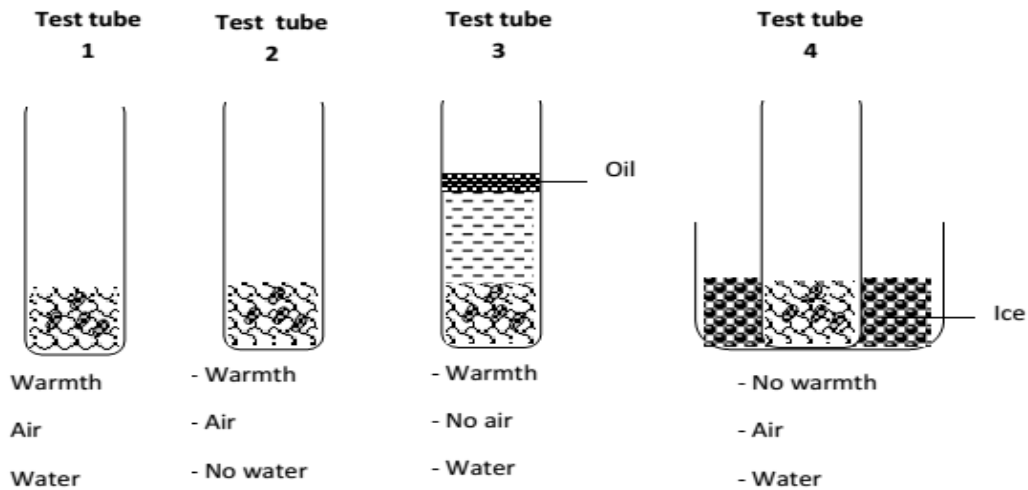

### Observations

Seeds germinated in only test tube 1 and those in 2, 3 and 4 did not germinate.

### Conclusion:

Air, water and warmth are necessary for germination.

### Experiment to show that oxygen is necessary for germination

#### Apparatus:

2 conical flasks, 2 corks, Water, Cotton wool, Seeds and Pyrogallic acid.

#### Procedure:

- ✓ 1. Pour some water in one conical flask and some alkaline pyrogallol in another conical flask.
- ✓ Tie some seeds in wet cotton wool and suspend the cotton wool in the flasks using a thread.
- ✓ Fix the threads using a cork.
- ✓ Leave the set up for three days

#### Set up:

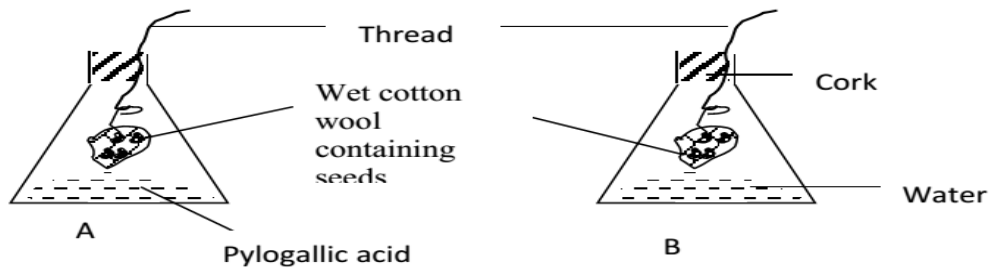

### **Observation:**

After a few days the seeds in B germinated while those in A did not germinate.

### **Conclusion:**

Oxygen is necessary for germination.

### **Explanation:**

Alkaline pyrogallol absorbs oxygen from air in flask A thereby preventing germination.

## **MEASUREMENTS OF GROWTH**

Measurement of growth involves the use of fresh weight and dry weight of a seedling.

### **1. Fresh weight/mass:**

This is the total amount of organic matter and water in an organism.

#### **Advantages of measuring growth by using the fresh weight of an organism**

- It does not involve the killing of the organism.
- It is a very method of determining growth.
- It is the most suitable method of determining growth of seedlings.

#### **Disadvantages of measuring growth by measuring the fresh weight of an organism**

- It is less accurate since the biggest part of an organism is water.
- It is not reliable because the mass keeps on fluctuating due to water loss by transpiration and evaporation.

### **2. Dry weight/mass**

This is the total amount of organic matter making up the body of an organism after removing water. It involves heating of an organism in an oven to a constant weight.

### Advantages

- ✓ It is a more accurate method of determining growth.
- ✓ It is reliable because constant results are obtained.

### Disadvantages

- It involves killing of an organism.
- The volatile tissues may decompose before removing all the water.

## CHANGES IN DRY WEIGHT OF A GERMINATING SEED

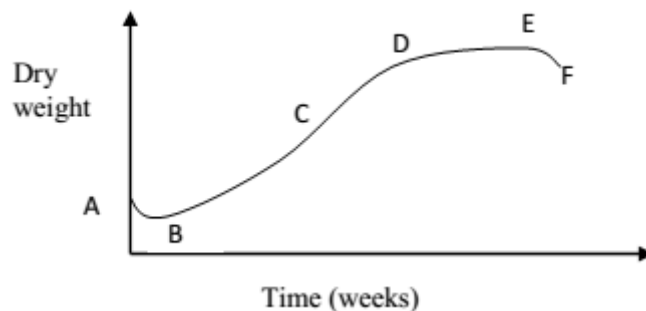

### Description and explanation of the graph:

From point **A-B**, the dry weight of the seed decreases. This is because the stored food in food reserves is hydrolyzed (broken down) to produce energy for germination.

From point **B-C**, the dry weight increases steadily and rapidly. This is because the seed has produced leaves, which are carrying out photosynthesis. It makes food, which causes its dry weight to increase.

From points **C-D**, the growth rate decreases. This is because the plant has matured and preparing for flowering and fruiting.

From points **D-E**, the dry weight remains constant. The plant has produced fruits and no more growth takes place.

From point **E-F**, weight drops because the seed are dispersed, the plant leaves dry and fall off. This causes a reduction in dry weight.

## CHANGE IN TOTAL WEIGHT OF A GERMINATING SEED.

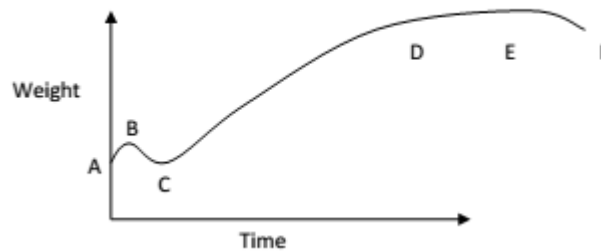

### Explanation of the graph:

Most of the changes are similar to those in the graph showing changes of dry weight with time in a germinating seed except that for dry weight, the weight of water in the seed is not considered. For the total weight of the seed during germination, water is put into consideration.

The initial slight increase in weight from point A-B is due to imbibition (absorption) of water into the seed. The other changes that follow in the subsequent points on the curve are similar to those in the change of dry weight with time.

## GROWTH CURVE

This is a graph which shows the change of a given growth parameter with time. This graph is S-shaped in most living organisms and it is called the sigmoid curve.

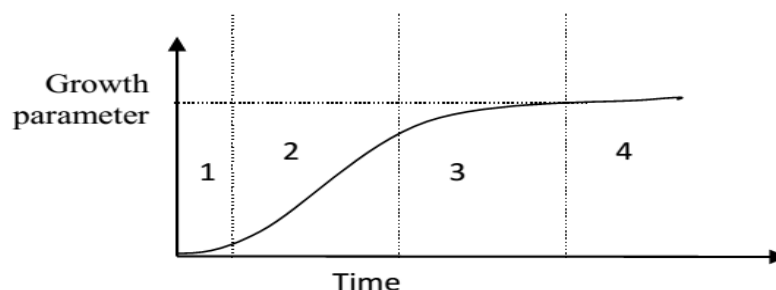

The curve shows 4 phases.

### 1. Lag phase.

This is a period of slow growth. It is the first phase of growth where there are very few cells dividing and the organism is getting used to the environment.

## **2. The exponential phase.**

This is a phase of rapid growth. It is the second phase where the cells dividing are many and the organism is used to the environment.

## **3. Decelerating growth phase.**

This is a period where growth slows down. The deceleration in growth may be due to;

1. Competition for food, space and other resources.
2. The organism is preparing for reproduction.
3. The organism is aging.

## **4. The plateau phase. /stationery phase.**

This is a period where there is no change in the growth parameter under investigation. At this point the number of cells, which die is equal to those produced.

After the plateau, the growth decelerates in seasonal organism due to aging and dispersal. In perennial organisms, growth increases continuously.

## **GROWTH AND DEVELOPMENT IN ANIMALS**

In animals growth occurs throughout the body of the organism unlike in plants where growth is localized in specific areas called meristems. Most animals grow continuously until they reach maturity. This is called continuous growth. In Arthropods like insects growth is discontinuous, i.e. there are periods of growth and no growth.

## **GROWTH AND DEVELOPMENT IN INSECTS**

Insects have an exoskeleton which is rigid and prevents expansion of the insect during growth. Before the insect grows, it sheds the exoskeleton in a process called moulting (ecdysis).

Without the exoskeleton, the insect expands and grows. A new exoskeleton then forms and growth ceases. This kind of growth is referred to as intermittent growth or discontinuous growth. Successive moults result into formation of a

new form of the insect. This is called metamorphosis. Metamorphosis has already been discussed under insects.

### A graph showing intermittent growth in insects

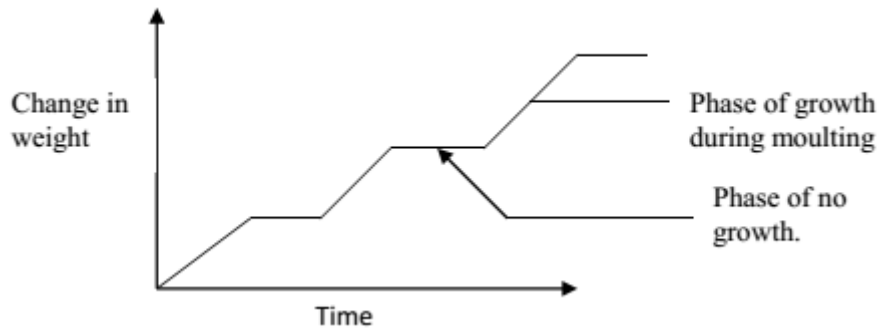

## GROWTH AND DEVELOPMENT IN VERTEBRATES

After fertilization, the zygote undergoes three changes during its growth and development. These changes are;

### 1. Cleavage:

This is the mitotic division of the zygote to form a mass of cells. The zygote at this stage is called a **blastocyst**.

### 2. Gastrulation.

This is the rearrangement of the cells into distinct layers. The outer cells make up a layer called ectoderm. The cells in the middle make up a layer called mesoderm and the inner cells make up the endoderm. From these layers the various organs and systems are formed.

### 3. Organogenesis:

This is the formation of organs and organ systems.

## REPRODUCTION

*Reproduction is the process by which organisms multiply to increase in number.* This is important in maintaining the life of organisms from one generation to another.

### Types of reproduction

There are two types of reproduction.

1. Asexual reproduction
2. Sexual reproduction.

## **ASEXUAL REPRODUCTION**

*This is a type of reproduction, which does not involve fusion of gametes, and therefore only one individual is involved.* This type of reproduction takes several forms, which include the following.

### **a) Budding.**

This is a mode of asexual reproduction in which an organism develops an outgrowth (bud), which detaches its self from the parent organism and starts to grow as a self-reliant organism. It is common in yeast and hydra.

### **b) Spore formation**

This is a mode of asexual reproduction, which involves production of spores. Spores are microscopic structures, which can be dispersed and have the ability to germinate into a new organism under favorable conditions. This mode of reproduction is common in fungi and some bacteria.

### **c) Fragmentation**

This is a mode of asexual reproduction where an organism breaks into many small parts (fragments) and each is able to grow into a new individual. It is common in tapeworms and spirogyra.

### **d) Binary fission**

This is a mode of asexual reproduction where a single celled organism divides up into two parts, which start to grow as separate individuals. It is common in amoeba and other protozoans

### ***Question:***

*Describe the process of asexual reproduction in;*

- i) Amoeba*
- ii) Rhizopus*
- iii) Yeast*

iv) *Spirogyra*

**e) Multiple fission**

This is a mode of asexual reproduction where a single celled organism divides into many parts, which grow into separate individuals. This occurs in plasmodium.

**f) Vegetative reproduction**

This is a mode of reproduction in plants where part of the plant other than the seeds develops into a new individual. This normally takes many forms, which include rhizomes, bulbs, corms, suckers, stolons, runners etc

**Table showing various types of vegetative propagation**

<b>Name</b>	<b>Characteristics</b>	<b>Examples</b>
Rhizome	Underground stem, swollen with food, has lateral buds, has scale leaves, has nodes and internodes.	Ginger, cana lily
Stolon	Underground stem, not swollen with food, has lateral buds, has scale leaves.	Couch grass, spear grass
Runners	Grows on the surface, has fibrous roots, has lateral buds, has scale leaves, has nodes and internodes.	Star grass
Bulbs	Leaves swollen with food, has a short stem, has adventitious roots, has scale leaves, has thick foliage leaves, has lateral buds.	Onions, garlic
Corms	Vertical stem swollen with food, has adventitious roots, has lateral buds, has scale leaves.	Yams
Suckers	New individual plant produced alongside the	Pineapple, banana

	parent plant	
--	--------------	--

### **Advantages of vegetative reproduction**

- New plants resemble the parent plant and any good quality in the parent is retained.
- The growth of the new plant is rapid.
- The reproductive organ stores plenty of food which the new plant uses.
- It does not involve processes like pollination, fertilization and dispersal agents are not required.
- Large areas can be covered in relatively little time.
- It involved only one individual.

### **Disadvantages**

- Since new plant grows on its parent, it can lead to crowding.
- Shortage of water and mineral salts is likely to occur due to competition.
- Diseases of the parent plant can be transmitted to the young ones.
- If the parent plant has poor characters, they can be maintained by the young ones.

## **ARTIFICIAL VEGETATIVE PROPAGATION**

This is a mode of reproduction where man is involved in the propagation process. It is done in several ways, which include, budding, grafting, layering, cuttings, etc.

### **1. Budding**

This is the process where a bud is detached from a plant and grown in suitable conditions into a new plant.

### **2. Grafting**

This is the insertion of part of one plant onto another plant so as to come into organic union and to grow as one plant. The part inserted can be a bud or a shoot of a plant and it is called a **scion**. The part in the ground on which the scion is inserted is called a **stolk**. The scion and stolk should be of different varieties but same species.

### **3. Layering**

This is where a branch of a plant is bent to touch the ground and allowed to develop roots. When the roots are developed, it is cut from the plant and it starts to grow as a separate self-supporting plant.

### **Advantages of asexual reproduction**

1. It is reliable because it is less likely to be affected by adverse environmental factors like for the case of seeds.
2. It leads to genetic consistence since there is no mixing of genes during reproduction.
3. It results into early maturity because the organisms produced have enough food reserve from the parent.
4. It is self-sufficient because it does not rely on external processes like pollination, fertilization and dispersal.
5. It does not result in indiscriminate and wide spread distribution like in the case of seeds, which leads to wastage.
6. It does not require formation of sex organs.
7. It is the only means of reproduction in some organisms.

### **Disadvantages of asexual reproduction**

1. It leads to maintenance of bad characters.
2. It does not introduce variations in the offspring since there is no gene mixing.
3. It easily results into competition between offspring due to overcrowding.
4. It gradually results into reduction of the strength and vigour of the succeeding generations.
5. There is a high chance of disease transmission from parent to offspring.

## **SEXUAL REPRODUCTION**

This is a type of reproduction which involves the fusion of male and female gametes to form a zygote.

## SEXUAL REPRODUCTION IN NON FLOWERING PLANTS

### Reproduction in spirogyra

Spirogyra is a green non flowering plant belonging to a group of plants known as algae. The main type of sexual reproduction in spirogyra is conjugation.

- i) The opposite cells of the two different filaments lying side by side develop a swelling or an out-growth which begins to grow towards each other.
- ii) On touching they dissolve to form a conjugation tube and at the same time the contents change into gametes.
- iii) The gametes from one cell (male gamete) migrate through the conjugation tube to another cell (female) gamete.
- iv) The two gametes fuse to form a zygote which develops a thick resistant wall and becomes a zygospore.
- v) When the conditions are favorable, the zygospore germinates and grows into another filament.

Illustration

### Sexual reproduction in fungi (Rhizopus) E.g. mucor

- i) The tips of the two hyphae of different mycelia become swollen and grow towards each other until they touch. The two opposite swellings are referred to as positive and negative hyphae.
- ii) The swellings are cut off from the rest of the mycelia by a cross wall, nuclear division takes place and each swelling contains several nuclei.
- iii) When they touch, the wall dissolves and nuclei fuse in pairs. The thick outer cover forms around them to form a zygospore. This remains dormant for as long as conditions are unfavorable but germinate if the conditions are favorable.

Diagram to show sexual reproduction in rhizopus

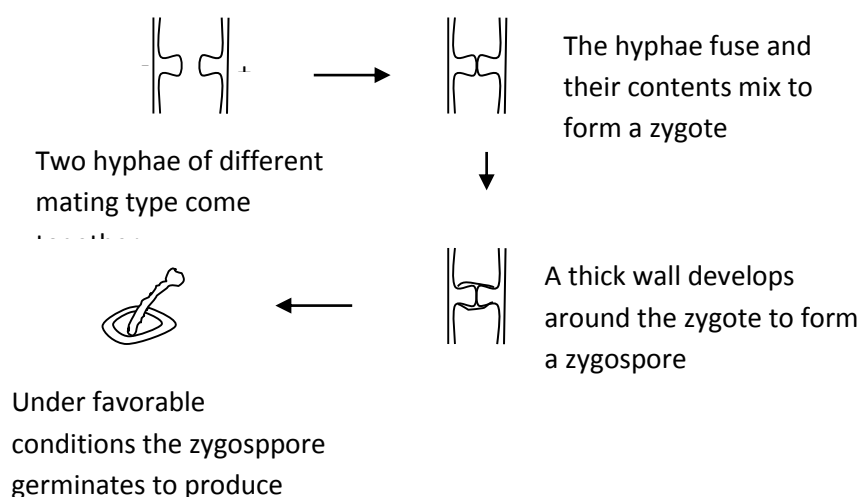

## **SEXUAL REPRODUCTION IN FLOWERING PLANTS**

In flowering plants the flower is the reproductive organ.

The male gametes are the male nuclei found in the pollen grains produced by the anthers.

The female gametes are the egg nucleus and polar nuclei found inside the ovules located in the ovary. These two are brought together shortly after pollination.

### **POLLINATION**

Pollination is the transfer of pollen grains from the anther of a flower to the stigma of the same flower or different flowers of the same species.

Pollination is of two types;

- Self-pollination
- Cross pollination

**Self-pollination;** is the transfer of pollen grain from anther of a flower to the stigma of the same flower.

**Cross pollination;** is the transfer of pollen grain from anther of a flower to the stigma of another flower of the same species. Flower may or may not be from the same plant.

#### **Features that promote cross pollination**

- Brightly colored petals.
- They have a nice scent to attract insects.
- Produce nectar which is food source for the insects.
- Stamen produce sticky pollen grains which adhere firmly to the bodies of visiting insects.
- The stigma are flat, lobbed and have sticky surface to which pollen grain can easily adhere.
- Presence of landing plat form and pollen guide which ensures that insects visit the flower.

- Stamen hanging outside the corolla to ensure that pollen grains are blown away by wind to another flower.

### **Characteristics of wind pollinated flowers**

- Usually not brightly colored
- Not scented and lack nectar.
- Stamen of wind pollinated flowers produce large quantity of light powdery pollen grains.
- Usually small and inconspicuous but are borne in large inflorescences.
- The stigma are large often feathery and hang outside the flower by long styles. This provides a large surface area on which pollen grains floating in the air may be trapped.

### ***Arrangements that promote self-fertilization (arrangements preventing cross pollination)***

- i) Maturation of both male and female parts of the flower at the same time.
- ii) Flowers borne underground.
- iii) Flowers being bi-sexual.
- iv) Flowers remaining closed.

### ***Arrangements that promote cross pollination (arrangements preventing self-pollination)***

- i) Possession of unisexual flowers such that both sexes appear on different plants (dioecious). E.g. in pawpaw
- ii) Self-sterility in monoecious plants like maize.
- iii) **Dichogamy**, a condition in which the stamens and pistils do not ripen at the same time. This results in failure of cross fertilization. If the stamens ripen before the pistil the condition is referred to as **protandry** while if the pistil ripens before the stamens it is called **protogyny**.
- iv) Stigmas being higher than anthers.

Differences between wind pollinated and insect pollinated flowers.

<b>Wind pollinated</b>	<b>Insect pollinated</b>
1. Produce light pollen grains	Produce relatively large and heavier pollen grains.
2. They produce large quantities of pollen grains	Produce small quantities of pollen grains.
3. They are usually not scented	They are scented.
4. Petals are dull colored.	Petals are brightly colored.

N.B:

Self-pollination has the disadvantage of failing to introduce variation in the new generation. This results into maintenance of poor characters from one generation to the next.

Cross pollination results into mixing of genetic material which leads to variation. This results into introduction of new character from one generation to the next.

## FERTILIZATION IN PLANTS

This is the fusion of male and female gamete to form a zygote. Fertilization in plants is internal taking place inside the ovary in the structure called embryo sac.

### The process of fertilization in plants:

7. Pollen grain lands on the stigma of a flower of the same species.
8. On the stigma, pollen grain absorbs water, nutrients and then germinates to form a pollen tube which grows through the style under the control of the tube nucleus at the tip.
9. Pollen grain has two nuclei i.e. generative nucleus and pollen tube nucleus. The generative nucleus divides mitotically to form two male nuclei which lie behind the pollen tube nucleus.

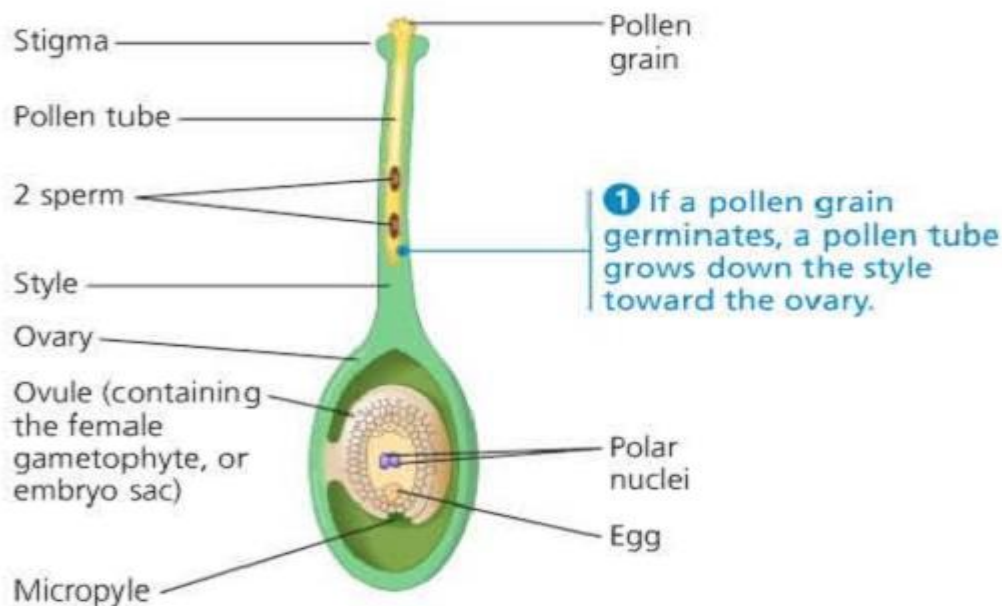

10. The pollen tube enters the ovary and the tip of the pollen tube breaks. The pollen tube nucleus disappears.

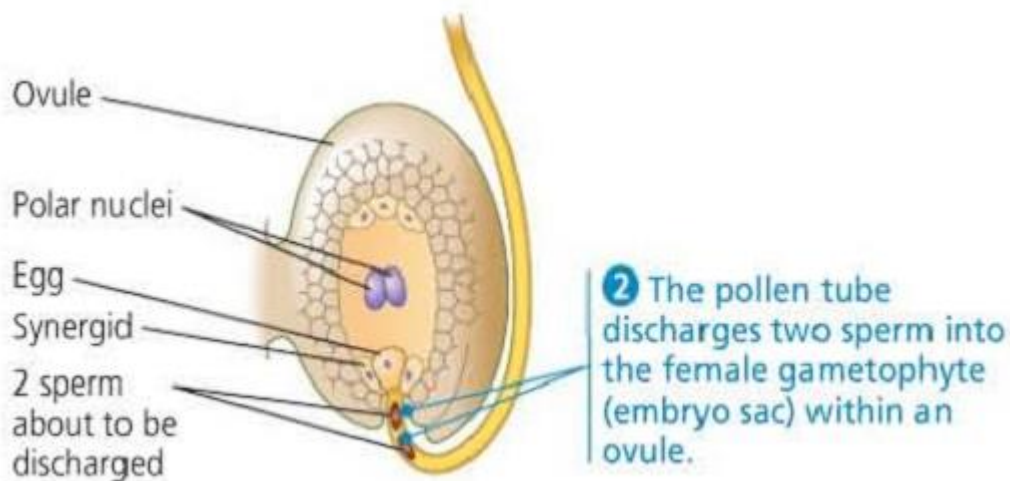

11. One of the male nucleus fuse with the egg nucleus to form a zygote which divides mitotically to form embryo.
12. The other male nucleus fuses with two polar nuclei to form a triploid endosperm which develops into endosperm. This is called double fertilization.

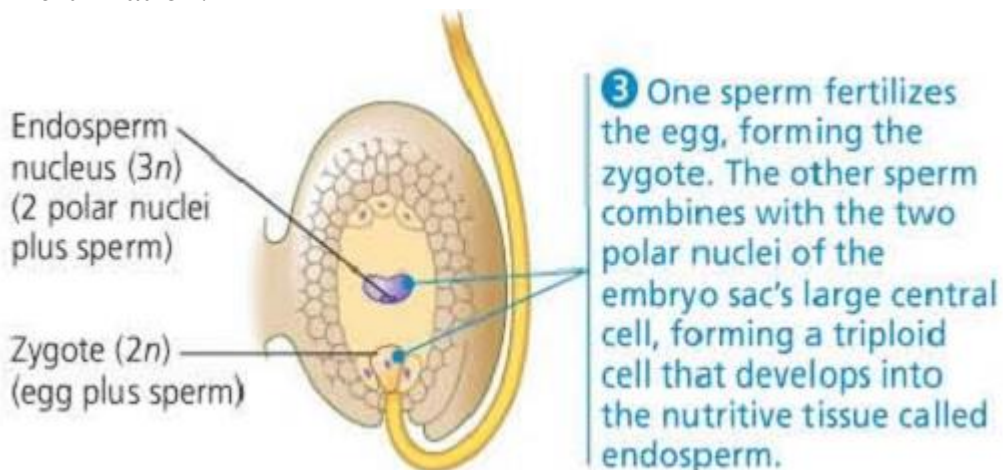

### Events after fertilization

7. The zygote divides mitotically followed by growth and development resulting into an embryo.
8. The triploid endosperm divides mitotically to form good solid organs called endosperm.
9. The ovules develop into seeds.
10. The integuments become the seed coat.
11. The ovary develops into a fruit and ovary wall develops into a fruit wall which protects the seeds.
12. Petals, stigma, style and stamen wither and fall off while the calyx may wither and fall off or may remain in shriveled form.

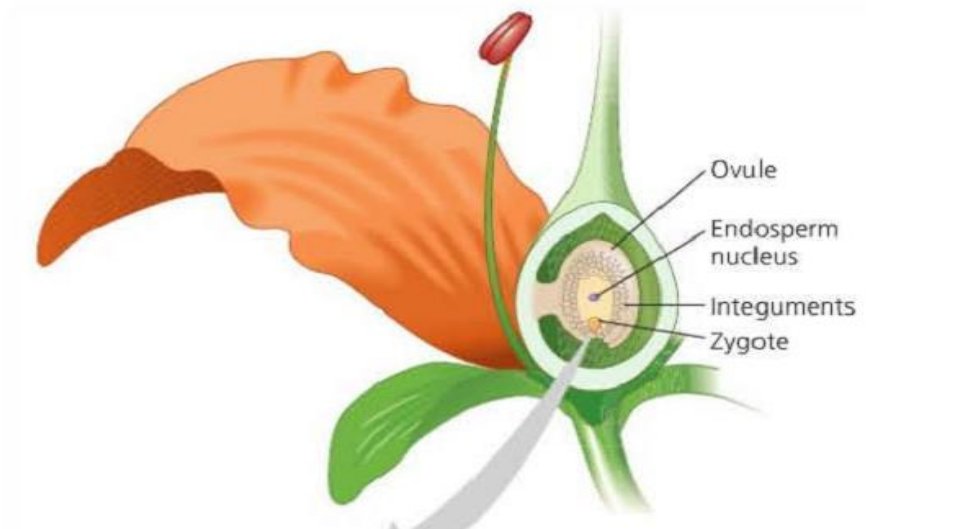

## **REPRODUCTION IN ANIMALS**

Sexual reproduction is the only form of reproduction in vertebrates and few invertebrates. E.g. Arthropods.

For this reason, most of animals have reproductive organs in which the gametes are produced. To adopt various conditions in the habitat in which they live different animals show different forms of fertilization and development.

### **Reproduction in insects**

Insects show internal fertilization and external development with complete and incomplete metamorphosis.

#### **Metamorphosis:**

This is the developmental change from the eggs to the adult stage in the life cycle of an organism. It is divided into two, i.e. complete and incomplete metamorphosis.

##### **i) Complete metamorphosis**

This is the type of metamorphosis where eggs hatch into larvae, pupa then to adult. It occurs in houseflies, butterflies and moths. Insects which show complete metamorphosis are called holometabolous insects.

##### **ii) Incomplete metamorphosis**

This is the type of metamorphosis where eggs hatch into nymph that resembles the adult except that it lacks wings, smaller than the adult and sexually

immature. It occurs in insects such as cockroaches, grass hoppers and locusts. Insects which show incomplete metamorphosis are known as hemimetabolous insects.

### **Sexual reproduction in Bony fish**

Like Tilapia, show external fertilization and external development beginning with laying of large quantities of eggs. Mating may follow courtship in some species and the eggs after hatching may get minimum parental care in form of protection from enemies.

### **Sexual reproduction in amphibians**

They show external fertilization and external development. There is some protection offered to the eggs by a jelly but there is lack of parental care to the tad poles.



### **Sexual reproduction in birds**

Birds show internal fertilization and external development. Prior or before fertilization most birds show courtship behavior, nest building and development begins with laying of eggs which hatches into young ones.

Courtship stimulates the female sexually to a point (nest) where the male bird is;

- ✓ On mating, the male presses his cloaca directly against the female's cloaca and sperms are released directly into the oviduct through the cloaca.
- ✓ The sperms swim up to the oviduct until they come into contact with the eggs without shell. Here internal fertilization takes place.
- ✓ The fertilized eggs pass to the oviduct where they release albumen and a hard protective shell.
- ✓ The eggs are laid in the nest and incubation starts after all the eggs are laid.

## Structure of the egg.

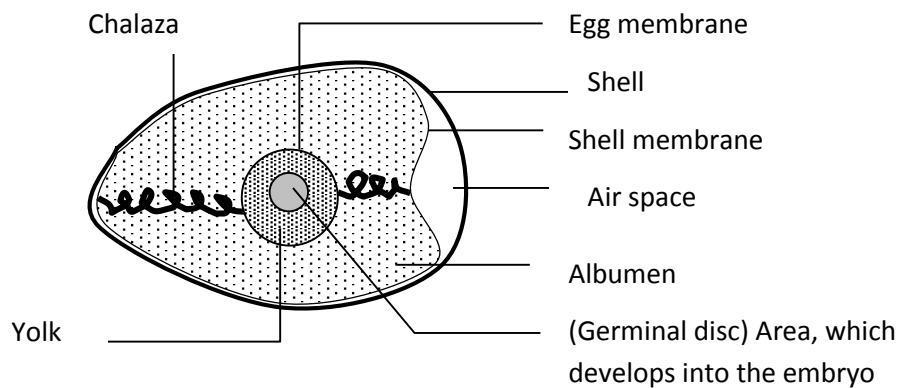

### Parts of the egg

1. **Shell;** this protects the egg and prevents it from desiccation.
2. **Airspace;** this stores air for gaseous exchange of the embryo.
3. **Charaza;** this holds the yolk in position.
4. **Albumen;** this is a source of proteins and fats to the embryo.
5. **Germinal disc;** this develops into an embryo.
6. **Yolk;** this stores food for and surrounds the embryo.

### Development:

The living cells in the egg divide to make the tissues and organs of the young birds. The yolk provides the food for this development. The albumen is the source of proteins and water. The shell and shell membrane are permeable to air. Oxygen diffuses into the airspaces and is absorbed through the blood capillaries of the embryo. The blood carries oxygen to embryo and Carbon dioxide is eliminated through the egg shell by the reverse process. When the chick is fully developed, it breaks out of the shell by help of its beak during hatching.

### Incubation:

The female bird is responsible for incubation of the eggs. The function of incubation is to provide the optimum temperature for the embryo's

development in the egg. The incubation period differs from one species of birds to another.

### **Differences between internal fertilization and external fertilization**

<b>External fertilization</b>	<b>Internal fertilization</b>
Water as an external factor is necessary	Water as an external factor is not necessary
A lot of gametes are produced and necessary	Less gametes are involved in the process
Embryos develop not well protected and mostly helpless after birth	Embryos develop well protected and normally offered help after birth
A lot of energy is involved since more gametes are produced.	Less energy is involved since fewer gametes are produced
Chances of fertilization occurring are fewer	Chances of fertilization are higher

*N: B the above points can serve as advantages of internal over external fertilization.*

### **SEXUAL REPRODUCTION IN MAMMALS**

Mammals reproduce sexually. They have special reproductive organs that produce the gametes i.e. sperms and ovum.

#### **THE MALE REPRODUCTIVE SYSTEM**

It consists of the testis, epididymis, seminal vesicles, prostate gland, Cowper's gland and penis.

#### **Vertical section through the male urino-genital system**

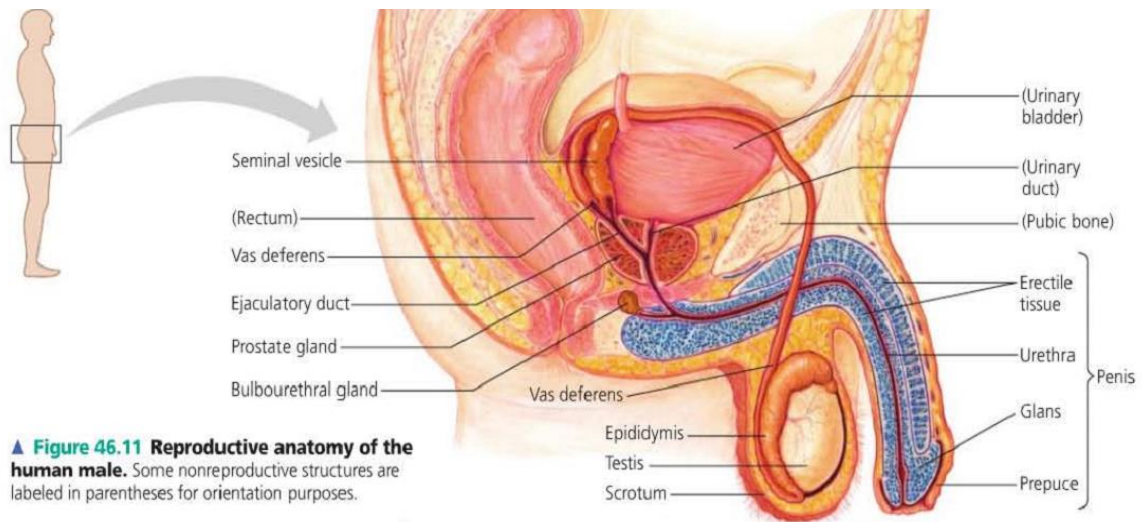

▲ **Figure 46.11 Reproductive anatomy of the human male.** Some nonreproductive structures are labeled in parentheses for orientation purposes.

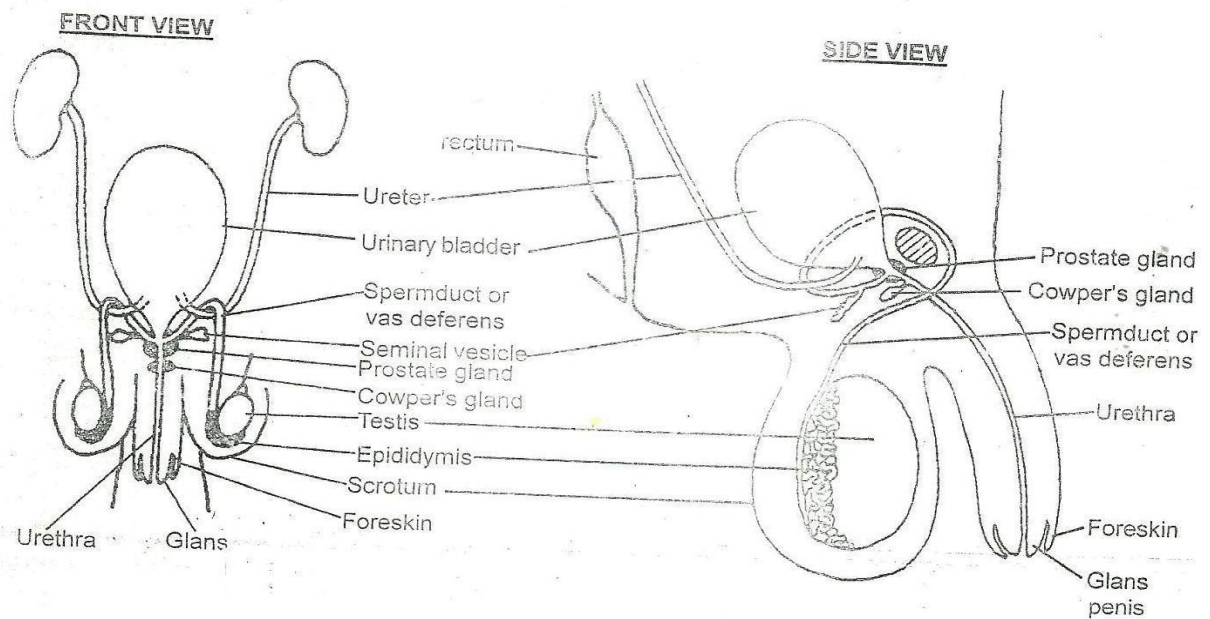

### Functions of the parts:

1. **Seminal vesicle;** secretes viscous fluid-containing fructose which acts as a nutrient for sperm cells.
2. **Prostate gland;** this gland secretes an alkaline, milky-white fluid that neutralizes the acidity of the Vagina.
3. **Penis;** delivers sperms into the female reproductive organ.
4. **Testis;** manufactures and store sperms.
5. **Scrotal sac;** protects the testis.
6. **Vas deferens;** conducts sperms from the testis to urethra during ejaculation.
7. **Urethra;** passage of sperms and semen during ejaculation.
8. **Cowper's gland;** produces mucus for lubrication of both the male and female urethra to ease copulation.

### Functions of the male reproductive system

- Used in the delivery of sperms into the female reproductive organ.

- Production and storage of sperms.
- Secretes male sex hormones e.g. testosterone hormone.

### **FEMALE REPRODUCTIVE SYSTEM**

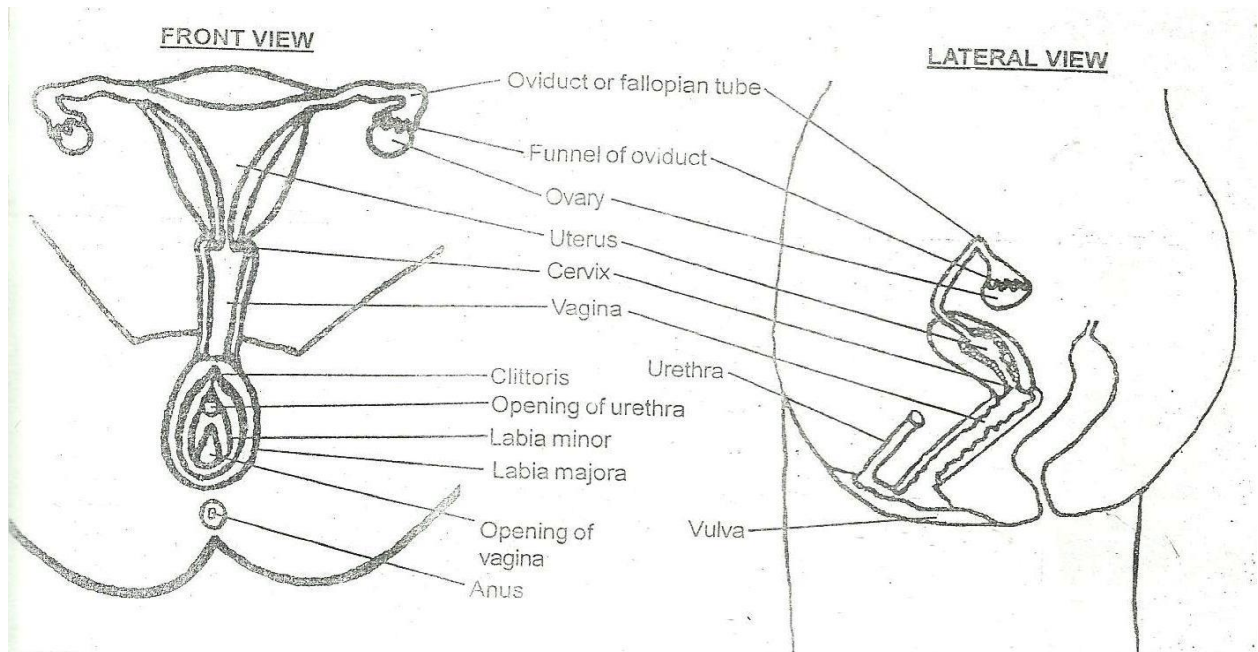

#### **Function of parts:**

1. **Uterus;** provides suitable environment for growth and development of the fetus. It is also an area for implantation.
2. **Vagina;** it provides the following functions;
  - Passage of sperms to the uterus.
  - Passage of blood during menstruation.
  - Allows passage of the fetus at birth.
3. **Oviduct (fallopian tube);**
  - It allows movement of fertilized egg towards the uterus for implantation.
  - It provides suitable place for fertilization.
4. **Cervix;** contains elastic muscles which allows its expansion during birth and it is the gate way to the uterus.
5. **Vulva;** This is a collective term for the external genitalia. It is made up of two skin folds that is the inner fold (**labia minora**) and the outer fleshy fold (**labia majora**). Labia minora contains mucus secreting glands which lubricates the vagina during sexual intercourse (copulation).

**Labia majora** cushion the vagina and helps in sexual arousal. In the place where labia majora and **labia minora** meet is a bean-like structure called **clitoris**. This is the most sensitive part, which brings about sexual excitement in females.

**6. Vagina;** This is a muscular tube, which connects the vulva to the uterus. It has an average length of 10cm. It secretes acidic mucus, which prevents growth of bacteria and fungi. The mucus also lubricates the vagina. The vagina plays the following roles.

- ✓ It is a passage for menstrual flow.
- ✓ It is a birth canal.
- ✓ It is where the male inserts his erect penis during sexual intercourse.

### **General function of the female urino-genital system**

- Production of the female gametes i.e. the ovum
- Reception of the male gametes i.e. the sperm
- Provision of a suitable environment for fertilization
- Provision of a suitable environment for the fetus development.
- Provision of a means for the expulsion of the developed fetus during birth.
- Secretion of hormones like oestrogen

### **GAMETES**

These cannot develop any further until fertilization occurs. There are two types of gametes namely; male and female gametes also known as sperm cells and ova (singular; ovum or egg cell) respectively. Both male and female gametes are haploid.

#### **The structure of a sperm cell (male gamete)**

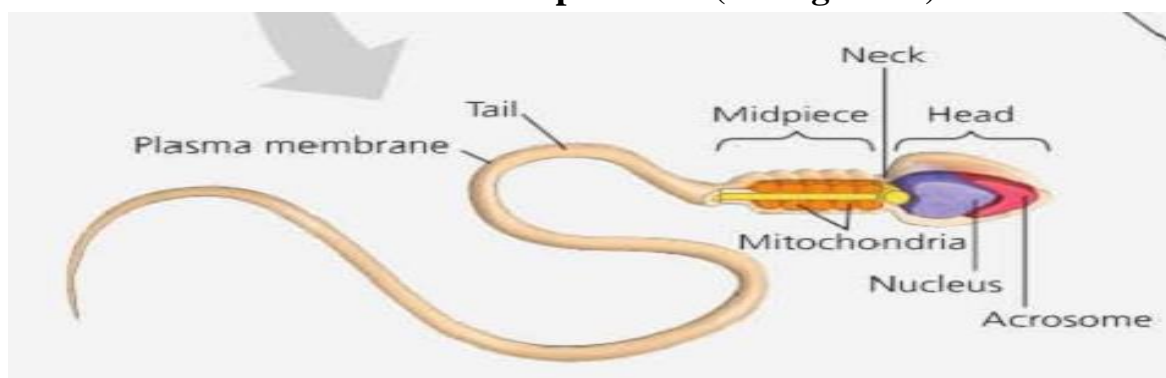

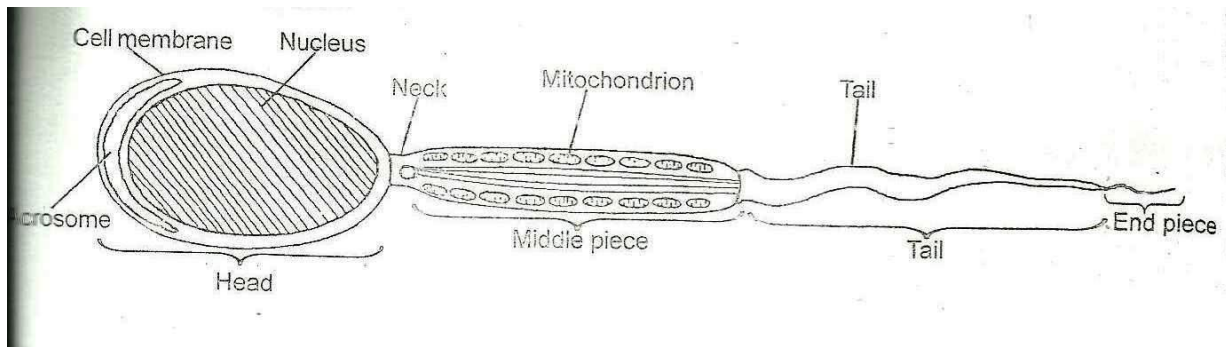

### The structure of the ovum

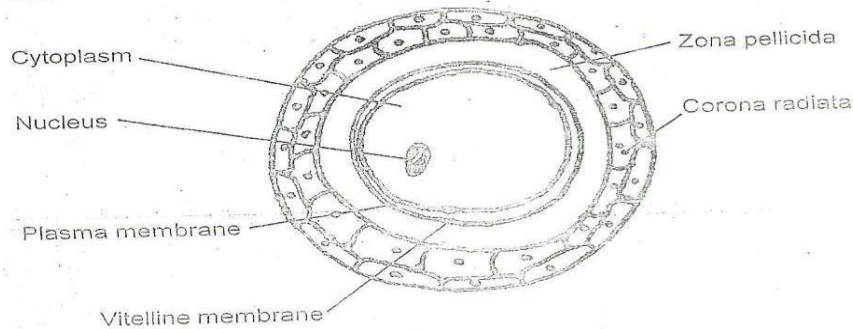

### Functions of the parts:

1. **Acrosome;** contains juice together with enzymes which dissolve the egg membrane (Vitelline) to bring about fertilization.
2. **Nucleus;** contains genetic material which is responsible for transmission of characters from the parent to the off spring.
3. **Middle piece;** contains mitochondria which provides energy required for the movement of the sperm.
4. **Tail;** propels the sperm forward as it swims towards the ovum.
5. **Neck;** connects the head and tail of the sperm.
6. **Cytoplasm;** it acts as a food store for the embryo.
7. **Vitelline;**
  - It provides protection to the inner part of the egg.
  - Allows exchange of materials around the egg and its surrounding.

### Differences between sperm and ovum

Sperm cell	ovum
Has a tail	It is spherical and has no tail
It is very small	It is big
Has less food store	It has more food store
It is mobile	It is immobile
It has either X and Y chromosomes (XY)	It has only X chromosomes (XX)

## FERTILIZATION IN MAN

Fertilization in man occurs after copulation where erect penis is inserted into the vagina. At orgasm, the penis releases large number of sperms (200-300 millions) near the cervix. The cervix relaxes and opens as sperms swim through its opening to the uterus then to the oviduct where fertilization takes place.

When a sperm get into contact with the egg membrane, it releases enzymes from acrosome which breaks the egg membrane and enable the sperm cell penetrate into the cytoplasm of the ovum.

When the sperm cell enters, the egg membrane becomes thickened to form the fertilization membrane which serves as a barrier preventing the entry of other sperm cells.

The nuclear membrane of the two gametes breaks down and male nucleus fuse with a female nucleus to form a fertilized egg. This process is known as fertilization and the female is said to have conceived.

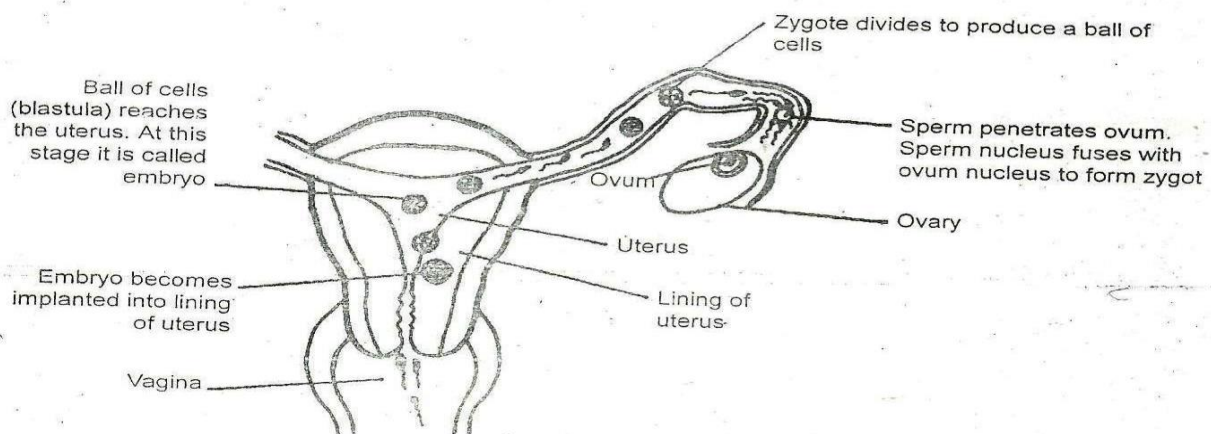

## PREGNANCY

Gestation is the period from fertilization of an ovum to birth. After fertilization, the under goes cell division by mitosis and move down to the uterus. Its movement is aided by constriction of the oviduct and it takes about one week. Finally the fertilized egg (zygote) is embedded in the lining of the uterus a process known as implantation and it continues with its development.

The fertilized egg now becomes known as the fetus. Later, finger like connections develop between the fetus and the mother's blood system. This later unites to form placenta connected to the fetus by umbilical cord.

### Diagram showing blood circulation to and from the fetus

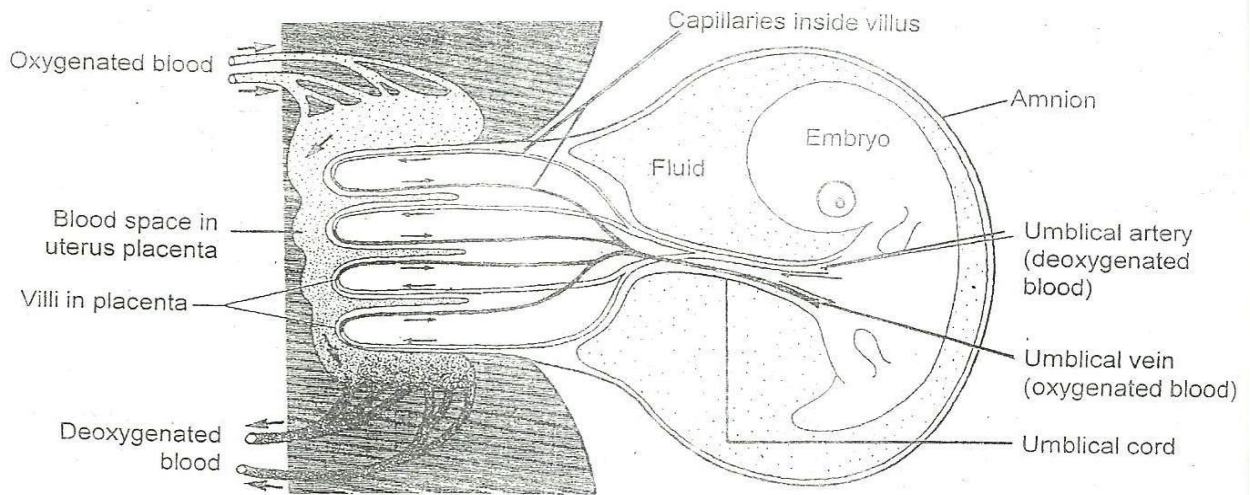

Or summarized as below

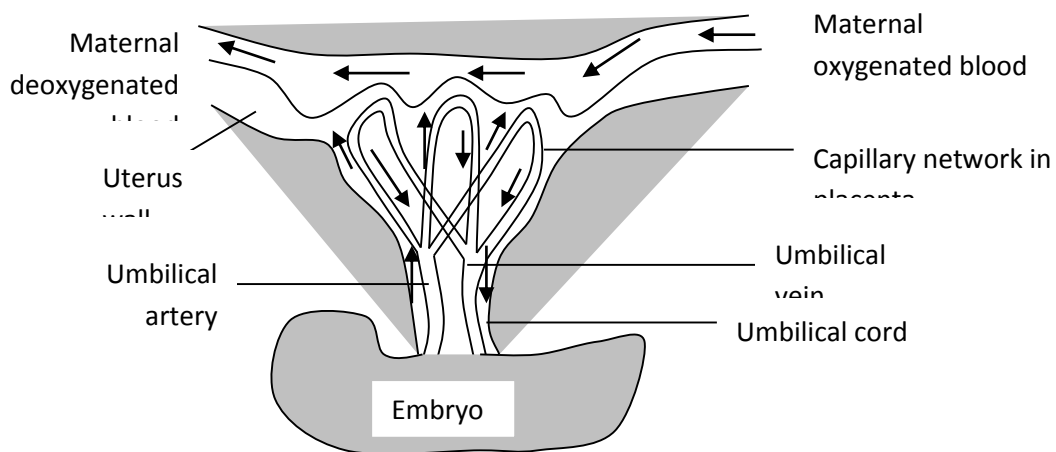
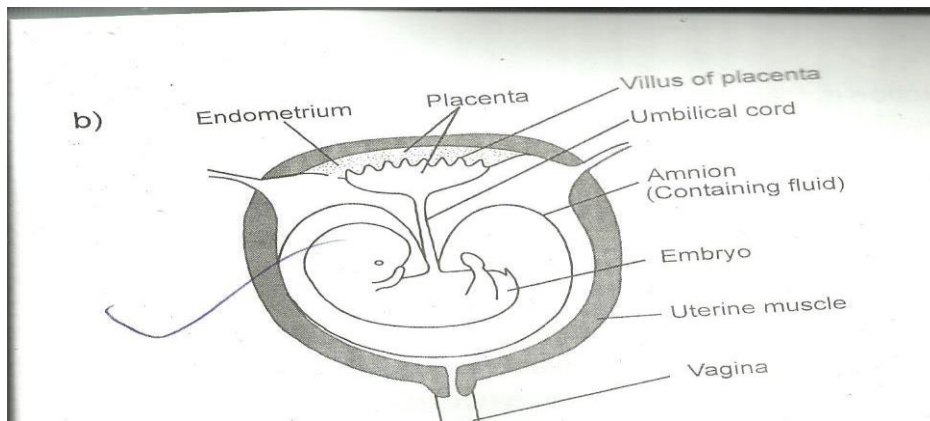

**Major nutrients needed by a pregnant mother**

- i) Calcium and Phosphates. These are needed for the development of bones and cartilage of foetus.
- ii) Iron needed for the formation of foetal red blood cells
- iii) Proteins needed for the formation of new tissue.
- iv) Vitamins needed for proper growth.

#### **Functions of the placenta**

- i) It allows exchange of materials without the mother's blood mixing with that of the fetus.
- ii) It allows transfer of oxygen, water, glucose, amino acids and other substances into the fetus which are used as nutrients.
- iii) Carbon dioxide, urea and other wastes are transferred from blood circulatory system of the fetus to the mother's blood across the placenta.
- iv) It protects the fetus by preventing certain toxins and foreign materials from crossing to the fetus.
- v) It acts as a barrier to mother's hormones and some other chemicals which may affect the fetus.
- vi) It allows anti bodies to pass onto the fetus there by providing immunity against diseases.

#### **Nutrition of the fetus**

Soluble food substances, oxygen, water and mineral salt passes across the placenta by either diffusion or active transport from the mother's blood to the fetal blood through the umbilical vein. Waste products such as carbon dioxide and nitrogenous wastes are brought in to the placenta by umbilical artery where they are passed into mother's blood. The placenta is therefore the excretory organ of the fetus as well as respiratory surface and source of nourishment.

#### **Protection of the fetus**

The fetus is contained in a sac called the amnion which is filled with amniotic fluid. The amniotic fluid protects the fetus from mechanical shock and drying.

The fetus is warmed by blood temperature all the time and regulated by mother's blood.

The placenta prevents passage of bacteria, other foreign materials, nervous transmissions and maternal blood pressure from affecting fetal circulation and also it keeps out toxins from the fetus.

#### **BIRTH (PARTURITION)**

The embryo turns head down wards in the uterus a few days before birth which occurs at approximately 9 months after fertilization. At time of birth, the uterus contracts rhythmically.

The opening of the cervix dilates (relax) to allow the young's head to pass through. The amniotic fluid passes out through the vagina.

The contraction of the uterus pushes the young one through the vagina to the exterior. It takes the 1<sup>st</sup> breathe of life and usually cries, a sign of changed conditions in its environment. After some time the placenta separates from the uterus and finally expelled as after-birth.

### **Differences between sexual and asexual reproduction**

<b>Sexual reproduction</b>	<b>Asexual reproduction</b>
i) Two parents are involved	Only one parent is involved
ii) Needs males and female gametes	Does not need gametes
iii) Off springs are not identical	Off springs produced are identical
iv) Rate of reproduction is slow	Rate of production is fast
v) Fertilization usually occurs	Fertilization does not occur
vi) Usually few off springs are produced	Usually very many off springs are produced

### **MALE HORMONES**

At puberty, the hypothalamus stimulates the anterior part of the pituitary to release two hormones.

- i. The **follicle stimulating hormone (F.S.H)** which stimulates sperm production.
- ii. The **Luteinizing hormone (LH)** also known as the interstitial cell stimulating hormone (ICSH) which stimulates the interstitial cells of the testis to release another hormone **testosterone** which stimulates the development of the male secondary sexual characters.

#### **Secondary characteristics in man**

- ✓ Deepening of the voice
- ✓ Growth of pubic hair
- ✓ Enlargement of the penis
- ✓ Onset of wet dreams
- ✓ Growth of beards
- ✓ Growth of hair in the arm pits

#### **Secondary characteristics in females**

- ✓ Softening of the voice
- ✓ Enlargement of breasts

- ✓ Enlargement of hips
- ✓ Onset of menstruation
- ✓ Enlargement of reproductive organs
- ✓ Growth of pubic hair
- ✓ Growth of hair in arm pits

## **FEMALE HORMONES AND THE MENSTRUAL CYCLE**

When the ovum is released by the ovary, the uterus wall thickens with addition of new layer of cells for the ovum to sink if fertilized. The blood supply also increases at the same time. If the ovum is not fertilized, the new layer of cells breaks down and the unwanted cells, mucus and some blood pass out through the cervix and vagina. This is called menstruation. It takes place once about 28 days, 12-14 days after the release of the ovum.

### **The menstrual cycle**

The menstrual cycle is controlled by four hormones of which two are secreted from **the interior lobe of pituitary gland and the other two from the ovaries**. The pituitary gland secretes **Follicle stimulating hormone (FSH) and Luteinizing hormone (LH)** and the ovary secretes **progesterone and oestrogen**. The four hormones are secreted in the following sequences.

FSH —————→ Oestrogen —————→ LH —————→  
 Progesterone

It is a reproduction cycle occurring in sexually a mature female in absence of pregnancy and involves series of changes in the female reproductive system which is controlled by hormones.

#### **1. Follicle stimulating hormone (FSH)**

- ✓ Causes the development of the graafian follicles in the ovaries.
- ✓ It stimulates the ovary to produce oestrogen.

#### **2. Oestrogen.**

- ✓ This stimulates the repair of the uterine wall after menstruation.
- ✓ When in high levels, it stimulates the pituitary gland to produce LH
- ✓ It inhibits the production of FSH from the pituitary gland.

#### **3. Luteinizing hormone (LH)**

- ✓ This cause ovulation in the middle of the cycle.
- ✓ It also stimulates the ovary to produce progesterone from the corpus luteum.

#### 4. Progesterone.

- ✓ This maintains the uterine lining in preparation for implantation.
- ✓ It inhibits production of FSH and LH if its level is high.

This leads to the breakdown of the corpus luteum within 14 days after ovulation and hence stops the production of progesterone.

If the ovum is not fertilized;

- When production of progesterone stops, the endometrium breaks leading to the flow of blood a process called menstruation.
- If fertilization occurs, the placenta produces the progesterone which prevents menstruation and maintains pregnancy.

Menstruation stops at around the age of 45 years on average and one is said to have reached menopause. At this stage no more pregnancy is possible.

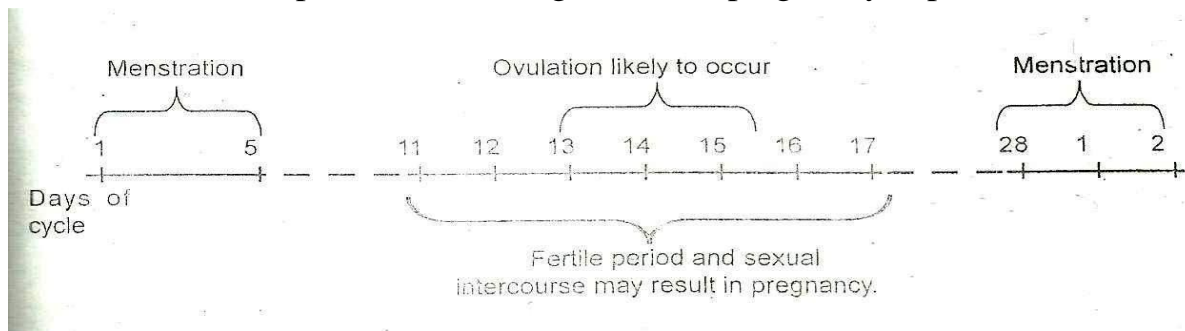

**Graph illustrating the hormonal changes in blood during a menstrual cycle.**

### A. OVARIAN CYCLE

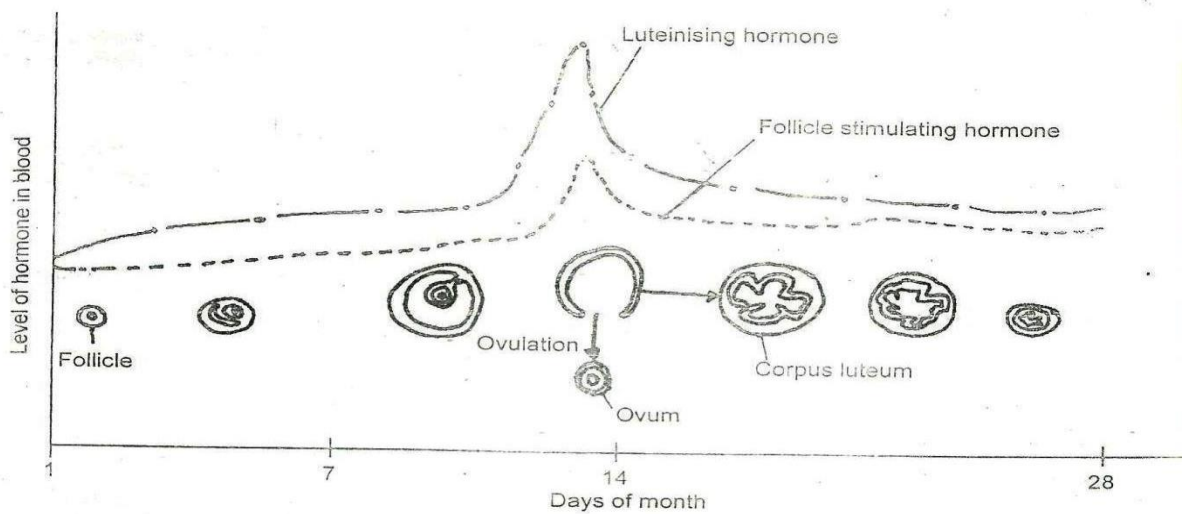

### B. UTERINE CYCLE

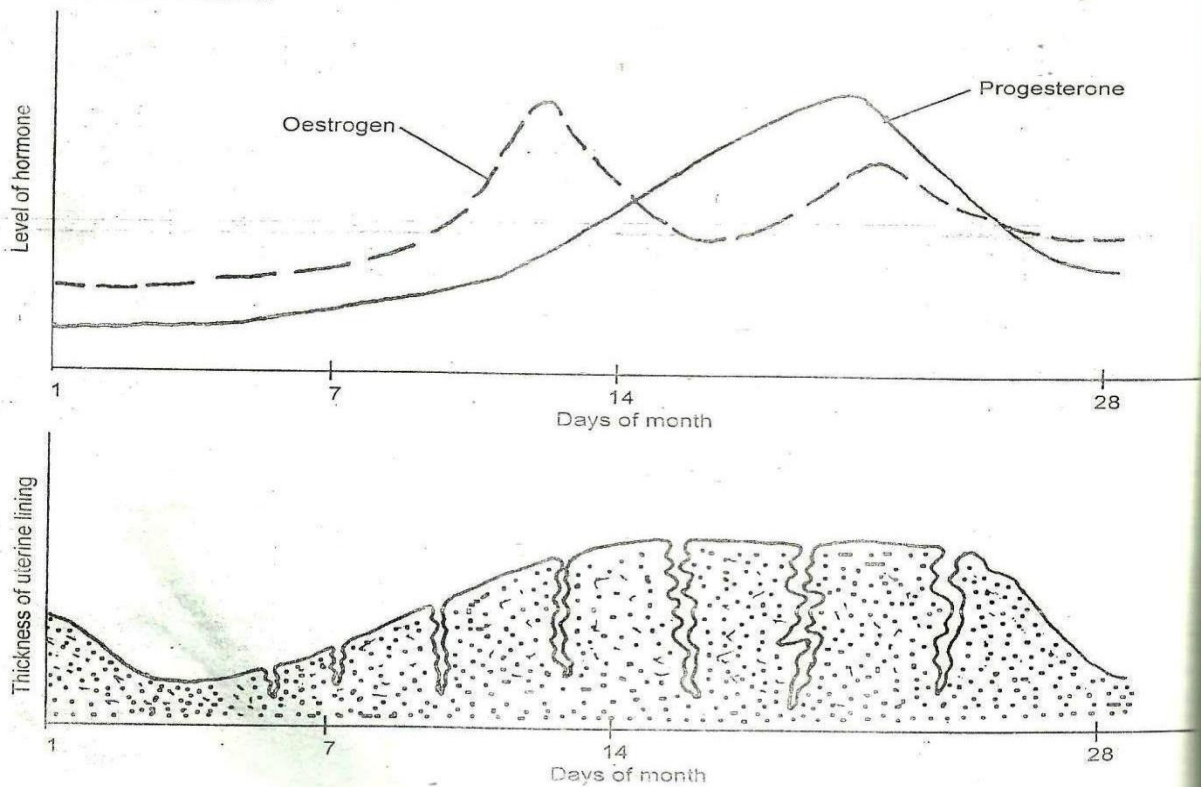

## SAFE PERIODS

It refers to the days within the menstrual cycle when there is no mature ovum in the reproductive system so a female can have sexual intercourse without getting pregnant.

During the first safe period, there is development of a graafian follicle and takes about 10 days from the end of menstruation.

A female should obtain for first 2 days before ovulation and 2 days after ovulation because the sperm cannot survive for more than 2 days. The 2<sup>nd</sup> safe period starts from around the 18<sup>th</sup> day up to the 28<sup>th</sup> day. Thus a mature egg dies after waiting in vain.

### **TWINS**

These are two babies produced with in the same time to the same mother as a result of the same pregnancy.

#### **Types of twins**

1. **Fraternal twins.** These are twins who arise from the fertilization of two ova produced at the same time and fertilized by two different sperms. The babies are not identical but resembles as normal babies in the family. They may or may not be of the same sex.
2. **Identical twins.** These are two babies, who develop from one fertilized ovum that latter divides into two and the two develop as separate individuals. Such babies look alike and are of the same sex

#### **Multiple births**

These are more than two babies produced to the same mother with in the same time as a result of the same pregnancy.

### **METHODS OF BIRTH CONTROL**

1. Coitus interruptus where the penis is withdrawn from the vagina before ejaculation.
2. Rhythmical method where sexual intercourse is avoided at times when ovulation is likely to occur.
3. Use of condoms and diaphragms which prevents sperm from reaching the eggs.
4. Vasectomy where vas deferens are cut by surgical means there by preventing the passage of sperms.
5. Tubal ligation where the fallopian tubes are cut by surgical means there by blocking the passage of the egg.
6. Use of oral contraceptives known as pills, these prevents development of the egg.
7. Use of injectable contraceptives. This is taken every 3 months to prevent ovulation.

8. Intra uterine devices. This prevents fertilized egg from implanting into the uterus.
9. Use of intra-vaginal rings. This ring secretes progesterone like substance which inhibits development of the egg.
10. Use of morning pills which are taken 3 days after sexual intercourse.
11. Abortion which involves termination of viable pregnancies.

### ***QUESTIONS:***

What is vegetative reproduction in flowering plants?

Define the term menstruation.

Describe the menstrual cycle in females

What are the causes of infertility in males

Describe the process of fertilization in man

Describe the different forms of asexual reproduction in flowering plants.

## **CELL DIVISION**

Cell division is a process by which a cell divides to give rise to daughter cells. In single celled organisms like amoeba, this process results into increase in number of organisms while in multicellular organisms cell division brings about growth, repair of worn out tissues and formation of reproductive cells (gametes). During cell division, the nucleus divides into two followed by the division of the cytoplasm. The cell membrane constricts to surround the formed cells each containing a nucleus. This results into formation of daughter cells.

There are two types of cell division.

1. Mitosis.
2. Meiosis.

### **Important terms used**

**Chromosome;** this is a thread-like structure in the nucleus that carries the genes of an organism.

**Chromatid;** this is one half of a chromosome.

**Sister chromatids;** these are chromatids of the same chromosome.

**Homologous chromatids;** these are chromatids of different chromosomes in a bivalent.

**Bivalent;** this is a pair of homologous chromosomes.

**Centromere;** this is a structure of chromatid attachment and separation on a chromosome.

**Chiasmata;** this is a crossing over point between two homologous chromatids.

**Haploid;** this is where a cell has half the number of chromosomes compared to the parent cell.

**Diploid;** this is where a cell has a whole set of chromosomes.

**Replication;** this is where a structure produces an exact copy of itself.

## MITOSIS

*This is a type of cell division where a cell divides to give rise to two daughter cells each having the same number of chromosomes as the parent cell and each having exactly the same number of chromosomes as the parent cell.*

The daughter cells are diploid i.e. they have 2 sets of chromosomes.

This cell division consists of 4 stages namely:

1. Prophase
2. Metaphase
3. Anaphase
4. Telophase

The resting stage in between the 2 division is called interphase. Through interphase is regarded as a resting phase, the cell is engaged in several activities to prepare for division.

The following are the significant features of the stage.

- i) Chromosomes are drawn into long threads of chromatids.
- ii) The genetic material or chromosomes replicate to provide enough space for the two cells.

- iii) The cell manufactures and stores energy through respiration in preparation for cell division.
- iv) The centrioles replicate if present.

### Stage 1: prophase

- The chromosomes thicken and become visible.
- Each chromosome appears to consist of two chromatids lying parallel to each other and attached at a point called the centromere as shown below.
- The nucleolus disappears.
- The centrioles migrate to opposite poles and start forming microtubules known as spindle fibers. The region between the two opposite poles is known as the equator.
- The nuclear membrane disintegrates and disappears towards the end of prophase.

#### Early prophase.

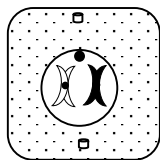

Centrioles at opposite

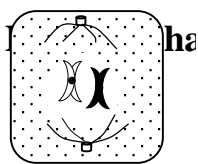

Centrioles form spindle fibers. The nuclear membrane disappears.

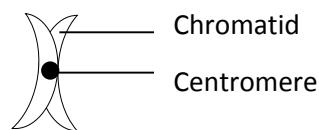

### Stage 2: metaphase

- Chromosomes move to the center of the cell and arrange themselves at the spindle equator.

- Chromosomes attach to the spindle fibers at the centromeres.
- Sister chromatids face opposite poles of the spindle.

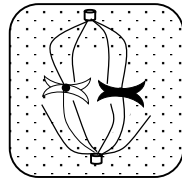

Chromosomes  
align at the

### Stage 3: anaphase

- Centromeres divide and the two chromatids of each chromosome move to opposite poles.
- Each chromatid now becomes a chromosome.
- Spindle fibers shorten as they pull the chromatids apart.

### Stage 4: Telophase

- The chromosomes reach the poles.
- The cell divides by constriction of the cell membrane in animals or by forming a cell wall plate in plants.
- The nuclear membrane reappears.
- Spindle fibers disintegrate (break down).
- The nucleolus reappears.
- Chromosomes uncoil, become threadlike and invisible.
- This leads to interphase and the cycle repeats.

### Animal cell at telophase.

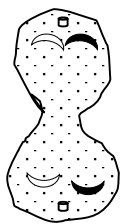

Chromosomes  
reach the poles  
and the cell  
constricts

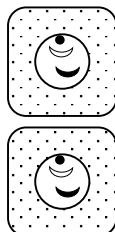

Nuclear  
membrane re-  
appears and two  
daughter cells are

**Note;** plant cells do not have centrioles but can form spindle fibers during cell division.

### **Major events during mitosis**

1. Replication of DNA, chromosomes and cell organelles during interphase.
2. Formation of the spindle and disappearance of the nuclear membrane during prophase.
3. Chromosomes align at the equator during metaphase.
4. Sister chromatids are pulled to opposite poles and they become chromosomes during anaphase.
5. Cells divide into two during telophase.

### **Significance/importance of mitosis**

1. Mitosis results into growth. As cells divide, they produce new similar cells. This causes an increase in the number of cells in an organism and consequently growth.
2. It brings about repair. During the course of life cells are damaged and they die. New cells are produced by mitosis to repair the body by replacing damaged and dead cells.
3. It is important in asexual reproduction. Cells divide by mitosis to form spores or tissues that develop into a new individual.
4. It maintains the genetic composition of the organism. Cells produced during mitosis are similar genetically to the parent cell. This ensures that the organisms' identity (genotype) does not change.
5. Gametes in bryophytes (mosses) are produced by mitosis.

### **Where mitosis occurs**

In man, it mainly occurs in;

- The bone marrow
- The epidermal cells of the gut

- The malpighian cells of the epidermis

In plants, it occurs in;

- The apical meristems
- The cambium

## MEIOSIS

This is a type of cell division where a cell divides into four haploid daughter cells each with half the number of chromosomes as the parent cell. It is also called reduction division because it halves the number of chromosomes in the daughter cells. Meiosis takes place in reproductive organs during the formation of reproductive cells (gametes).

Meiosis occurs in two major phases.

1. Meiosis I (first meiotic division)
2. Meiosis II (second meiotic division)

*The first meiotic division results into separation of homologous chromosomes while the second meiotic division results into separation of sister chromatids.*

Like in mitosis, during interphase, the cell carries out several activities to prepare for division. These include;

- Replication of the genetic material
- Replication of the centrioles
- Large stores of energy built up

## MEIOSIS 1

*The stages of meiosis are;*

### 1. Prophase 1

- This is the longest stage in meiosis. During this stage;
- The nucleolus disappears.
- Centrioles migrate to opposite poles.
- Spindle formation starts.

- Homologous chromosomes lie side by side. This is called **synapsis**. A pair of homologous chromosomes at this stage is called a **bivalent**.
- Chromatids of homologous chromosomes (homologous chromatids) exchange portions at certain points called chiasmata in a process called crossing over.
- The nuclear membrane disintegrates.

## 2. Metaphase 1

During metaphase I

- Spindle formation continues.
- Homologous chromosomes – now in a pair – align themselves at the equator of the spindle with their centromeres facing opposite poles.
- Spindle fibers attach at the centromere of each chromosome.

## 3. Anaphase 1

During anaphase I;

- Homologous chromosomes separate and they move to opposite poles.

## 4. telophase 1

During telophase I

- Chromosomes arrive at the poles.
- The cell divides into two as in mitosis.
- The nuclear membrane reforms in each of the new cells.

**Note:** A bivalent is a pair of homologous chromosomes. Bivalents are formed during prophase 1

### Structure of a bivalent

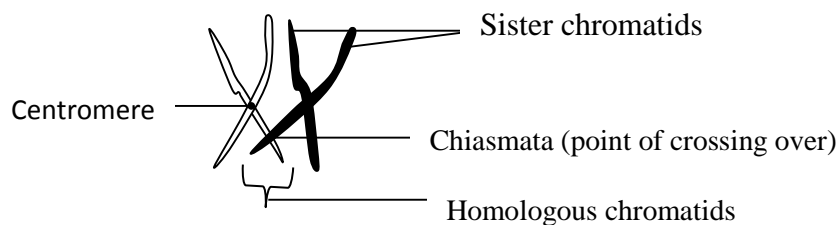

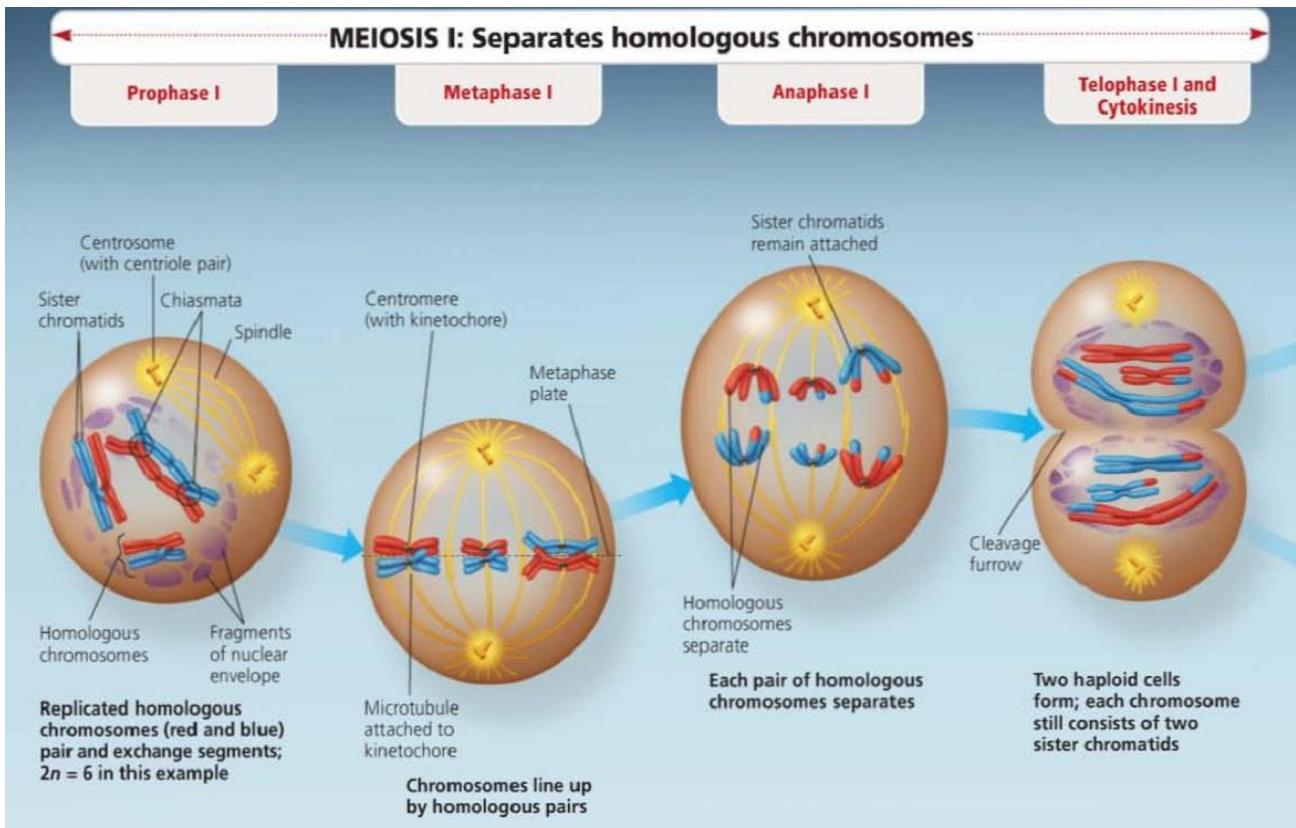

## MEIOSIS II

After meiosis I there is usually a short period of interphase but some times it does not occur.

Meiosis II is also divided into the following stages.

1. Prophase II
2. Metaphase II
3. Anaphase II
4. Telophase II

### 1. Prophase II

- A spindle starts to form.
- Centrioles replicate and migrate to opposite poles.
- The nuclear membrane disintegrates at the end of prophase II

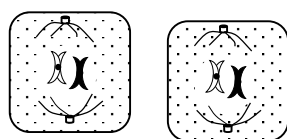

### 2. Metaphase II

During metaphase II;

- Chromosomes align at the equator with centromeres facing opposite poles.
- Centromeres divide and sister chromatids separate.
- Spindle fibers attach to the sister chromatids at the centromere.

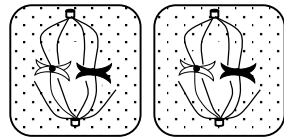

### 3. Anaphase II

During anaphase II;

- Chromatids separate and move to opposite poles.
- Chromatids now become chromosomes.

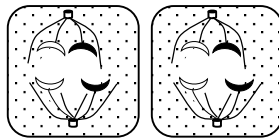

### 4. Telophase II

During telophase II;

- Each cell divides into two. These results into 4 daughter cells formed.
- The nuclear membrane reappears in each cell.
- Spindle fibers disappear.
- The nucleolus reappears.
- Chromosomes uncoil and become thread-like.

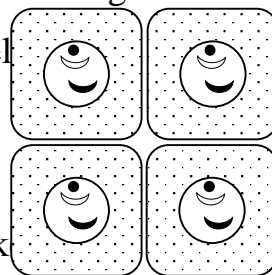

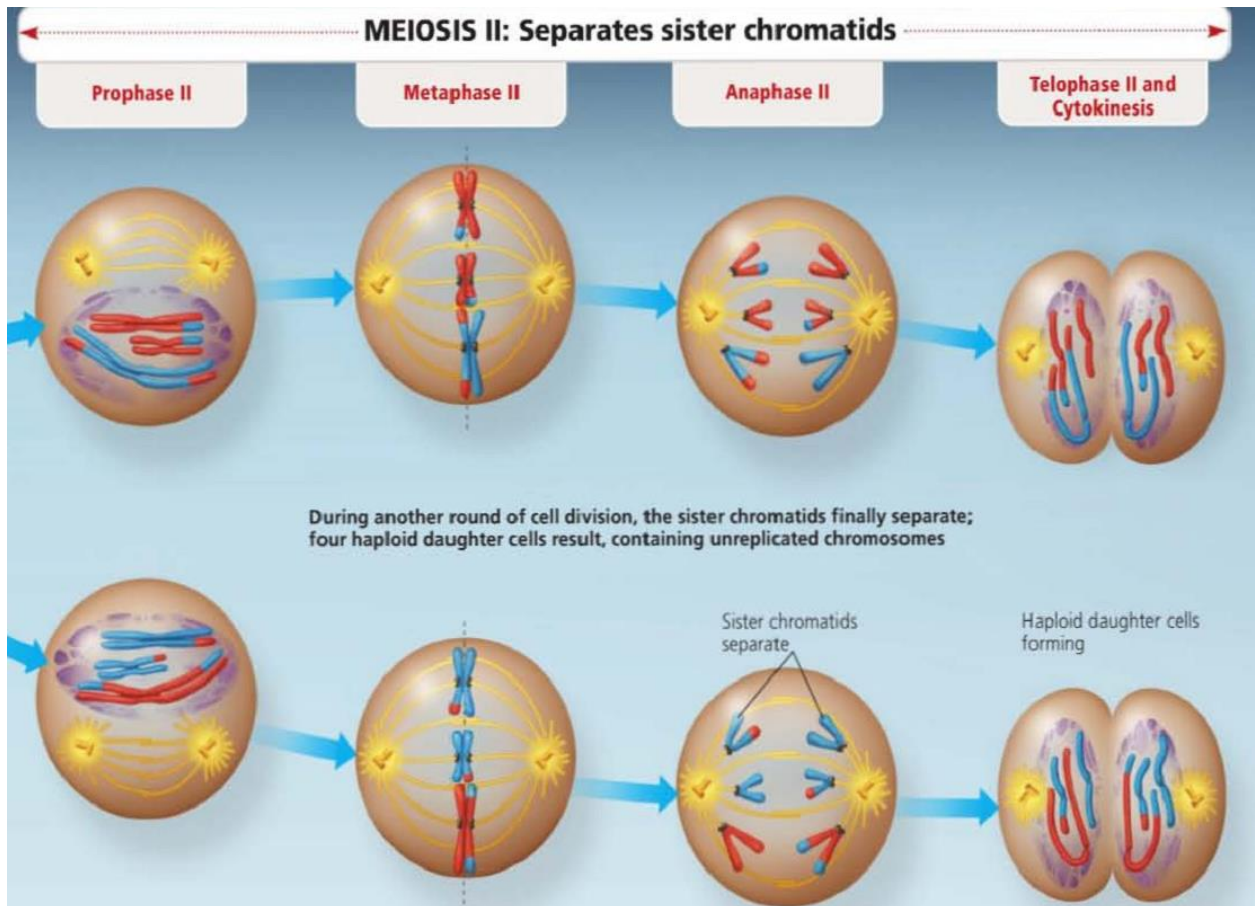

### Significance/importance of meiosis

1. It is important in formation of gametes.
2. It halves the chromosome number to ensure that the total number is restored during fertilization.
3. It introduces variations within cells through crossing over during prophase I
4. It results into rapid multiplication of cells since 4 are produced in a single division.
5. Since it occurs in reproductive cells, it results into varied offspring during sexual reproduction. This provides a basis for natural selection, which ensures evolution of the species.

### Comparison between mitosis and meiosis

#### Similarities:

1. Both are types of cell division.

2. They both involve replication of chromosomes.
3. They both involve similar stages e.g., prophase, metaphase, anaphase, telophase and interphase.
4. In both chromosomes arrange themselves at the equator.
5. In both a spindle is formed.
6. Both begin with a diploid parent cell.

**Differences:**

<b>Mitosis</b>	<b>Meiosis</b>
Occurs in somatic cells.	Occurs in reproductive cells.
Involves a single division of chromosomes and cytoplasm	Involves two divisions of chromosomes and cytoplasm.
Does not involve the process of synapsis	It involves synapsis
Crossing over does not occur	It involves crossing over between homologous chromatids.
Formation of bivalents does not occur.	There is formation of bivalents.
Two daughter cells are produced.	Four daughter cells are formed.
Diploid cells are formed.	Haploid cells are formed.
Daughter cells formed have the same number of chromosomes as the parent cell	Daughter cells formed have half the number of chromosomes compared to the parent cell
Does not involve formation of chiasmata.	It involves formation of chiasmata

## **ECOLOGY**

Ecology is the study of organisms in relation to their environment.

## **Definitions of terms used in ecology.**

### **1. Environment:**

This refers to everything in the surrounding of an organism that influences its life. The environment of a tadpole for example is everything in the water where it lives.

### **2. Biosphere**

This is the part of the earth and its atmosphere that is occupied by living things or where life exists. It's the largest habitat.

### **3. Habitat**

This is a place where an organism lives. In the habitat, the organism obtains water, shelter and it is able to reproduce there. The habitat of a tapeworm is the mammalian intestines.

### **4. Population**

This is the total group of organisms of the same species living in a particular place at a given time.

### **5. Ecological niche**

This refers to a particular place an organism occupies within a habitat and the role it plays there.

### **6. Community**

This is a collection of populations living and interacting with non-living components. It is therefore the total of all organisms in an area.

### **7. Autecology**

This is the study of only one species of organism in relation to its environment, e.g. the study of a frog in relation to its habitat.

### **8. Synecology**

This is the ecological study of a community of plants and animals in a particular area.

### **9. Ecosystem**

This is a unit of the environment consisting of both living (biotic) and nonliving (abiotic) components interacting to form a self-sustaining unit. E.g. living things

may include fish, cockroaches, and nonliving things may include lake, pond, forest, etc.

The two major factors within an ecosystem include:

- ✓ The flow of energy through an ecosystem.
- ✓ Cycling of matter within an ecosystem.

## **COMPONENTS OF AN ECOSYSTEM**

The ecosystem is made up of two components;

1. The abiotic component (non living component)
2. The biotic component (living component)

### **THE ABIOTIC COMPONENT OF THE ECOSYSTEM.**

This is the non-living component of the ecosystem. Living organisms interact with the non-living components in their community to form a self-sustaining unit called an ecosystem.

The abiotic components in the ecosystem include the soil factors (edaphic factors).

#### **Edaphic factors:**

These are physical and chemical factors in soil and atmosphere that influence the life and activities of living organisms. These factors affect different organisms differently. Such factors include.

- 1) **Light intensity.** Light intensity affects the process of photosynthesis in plants, visibility in some animals and causes responses such as phototropism.
- 2) **Temperature.** This affects the activity of enzymes in the body of organisms and therefore determines the overall activity of an organism. Temperature also affects germination of seeds.
- 3) **Water.** This is a very important edaphic factor. Water is a component of the bodies of living organisms. It is a raw material for photosynthesis, it aids dispersal of seeds, it is an agent of pollination, it is a habitat for some organisms, it is a condition for germination, etc.
- 4) **Humidity.** This is the amount of water vapour in the atmosphere. Humidity affects the rate of transpiration in plants; it also affects the rate at which water is lost from the bodies of animals through evaporation.
- 5) **PH.** This is the alkalinity or acidity of soil. PH affects the dissolution of mineral elements in water; it affects growth of plants and microbes in an area, etc.

- 6) **Nutrients.** Presence or absence of a particular nutrient in soil determines the organisms, which can grow in that soil. Nutrients are required for proper growth of all organisms in the ecosystem.
- 7) **Oxygen concentration.** Most of the organisms are aerobic, i.e. they require oxygen for their respiration. Oxygen is abundant in air (21% by volume) however in water the concentration of oxygen varies due to factors that affect its dissolution in water and over exploitation by organisms. This affects the growth of organisms in water. In such a case anaerobic organisms can thrive and aerobic ones die.

### **BIOTIC COMPONENTS**

This is made up of living organisms in the ecosystem. They are categorized into the following.

#### **i) Producers**

These are green plants and some bacteria that are able to manufacture their own food by use of light, chlorophyll, Carbondioxide and water in the process called photosynthesis and chemosynthesis. They are nutritionally referred to as autotrophs.

#### **ii) Consumers**

These are organisms, which are not capable of manufacturing their own food. The consumers get their food by feeding on other organisms.

### **LEVELS OF CONSUMERS**

Consumers are classified into feeding levels called trophic levels. The classification is based on the type of food they feed on.

The feeding levels/trophic levels of consumers include:

- ✓ Primary consumer
- ✓ Secondary consumer
- ✓ Tertiary consumer

#### **The primary consumers (1<sup>st</sup> order consumers):**

These are organisms that feed directly on plants (producers). They are called herbivores. Examples are cattle, grasshoppers, goats, sheep, etc.

**The secondary consumers (2<sup>nd</sup> order consumers):**

These are organisms that obtain their food by feeding on primary consumers. They are also referred to as carnivorous organisms since they feed on flesh. Examples include cats and reptiles.

**The tertiary consumers (3<sup>rd</sup> order consumers):**

These are organisms that obtain their food by feeding on the flesh of secondary consumers. These are usually big carnivorous animals like lions, crocodiles, vultures and tigers

**iii) The decomposers**

These are organisms that feed on dead decaying organic matter. They are commonly called saprophytes. The major examples are bacteria and fungi.

Decomposers are important because they bring about decay of plant and animal tissues. This helps in the recycling of materials in the soil.

They also reduce the amount of wastes and litter in the environment

**BIOTIC INTERACTIONS**

Each category of feeding is known as a trophic level. Feeding methods are useful in showing the relationship that exists in a community by means of food chains and food webs.

**TYPES OF FOOD RELATIONSHIPS****FOOD CHAIN**

This is a feeding relationship between organisms showing which organism feeds on what. It is always expressed in a linear fashion beginning with primary producers and ending with tertiary consumers.

Organisms at the beginning of a food chain are usually numerous while organisms at the end of the food chain are often large and few in number.

The food chain shows the passage of energy from producers to consumers. Energy from the sun is fixed by producers (plants). The herbivores eat the plants and obtain this energy. The carnivores feed on herbivores and obtain this energy. At successive levels some energy is lost. At the end of the food chain energy reduces.

### Example 1:

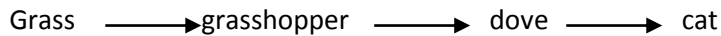

*In the food chain above, the grass is the primary producer, the grasshopper is the primary consumer, the dove is a secondary consumer and the cat is a tertiary consumer.*

Arrows are used to show the movement of energy from one organism to another. Energy moves from the producers to tertiary consumers through the food chain.

There are usually few links in the chain because as the links increase energy reduces and organisms feeding at the terminal end of the chain gain little energy.

Chemicals on the other hand accumulate in tissues and increase in succeeding levels in the food chain.

Elimination of one level from the food chain disrupts the food chain. For example in the above food chain, when the grasshoppers are eliminated from the ecosystem, the following occur.

- 1) The grass grows and increases in number because the grasshopper that used to feed on it has been removed.
- 2) The doves lack food because they feed on grasshoppers, which have been removed. This causes their numbers to drop.
- 3) The cats also reduce in number because as the doves die due to lack of food, the cats lack food and start to reduce because they feed on doves.

### Example 2

Draw a food chain for the following organisms;

- a) Vegetation, beetle, owl, fox

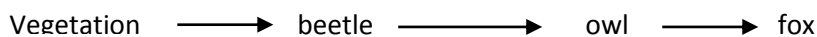

- b) cow, man, lion and grass.

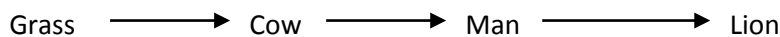

- c) Nile perch, algae, water flea and tilapia

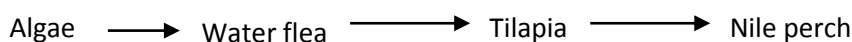

## FOOD WEB

A food web is a number of interlinked food chains. From the above food chains in example 1 and example 2a, the food web below can be obtained.

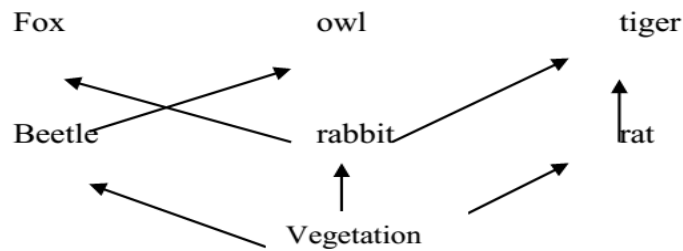

From the food chain b and c in example 2 above, the food web below can be drawn.

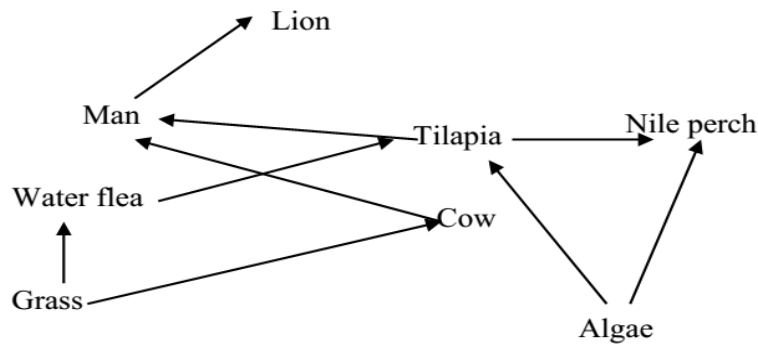

**Note.**

When drawing the food web, the organisms should be arranged in trophic levels. The produces should be at the bottom followed by primary consumers and tertiary consumers at the top of the food web.

## ECOLOGICAL PYRAMIDS

These are used to show either the number of organisms or energy present at each level in the food chain and food web. There are three types of pyramids namely;

1. Pyramid of numbers
2. Pyramid of biomass
3. Pyramid of energy

**1. Pyramid of numbers:**

This is used to show the number of individuals at each trophic level.

The number of organisms at each trophic level is counted and a pyramid is drawn with the primary producers at the base. The width of each rectangle represents the number of organisms at each trophic level.

**Illustration**



### Example 1

Draw a pyramid of numbers for 20 Nile perch, 40 planktons, 34 tilapia, 4 men

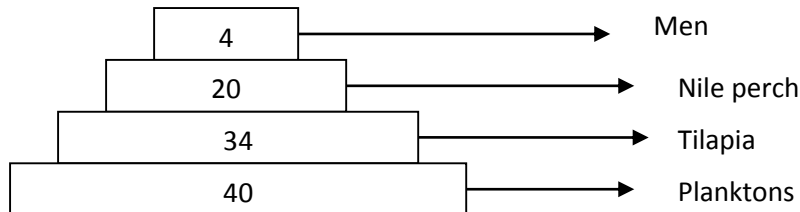

### Example 2.

Draw a pyramid of numbers for the food chain below.

1 Guava plant → 100 caterpillars → 20 birds

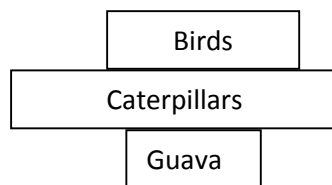

A big fruit tree may have several birds feeding on a fruit, man may be an alternate consumer of the birds while at the same time, several lice may be parasites to man.

The pyramid of numbers of such a chain may have the following form.

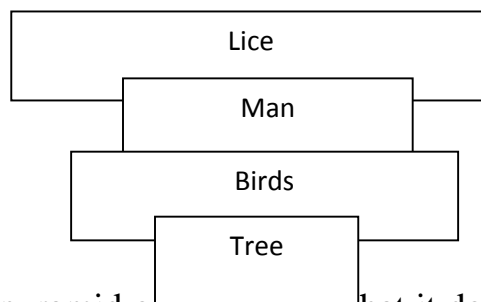

The problem with the pyramid of numbers is that it does not account for size of the organism at each trophic level. For this reason the pyramid of biomass is used.

**Question:**

Husnah carried out an ecological study in Kabowa. In one of the sections, she found 15 toads, 180 plants, 4 snakes and 120 grass hoppers. Use the information to answer the questions.

- Construct a possible food chain for the above information.
- State the trophic levels occupied by each of the organisms in the community.
- Draw the pyramid of number for the community.
- Explain what would happen to the rest of the organisms if all toads were destroyed.

**Solution:**

a) Plants → grass hopper → toad → snakes

b) Plants – producers

Grass hopper – primary consumer

Toad – secondary consumer

Snake – tertiary consumer

c) Pyramid of numbers

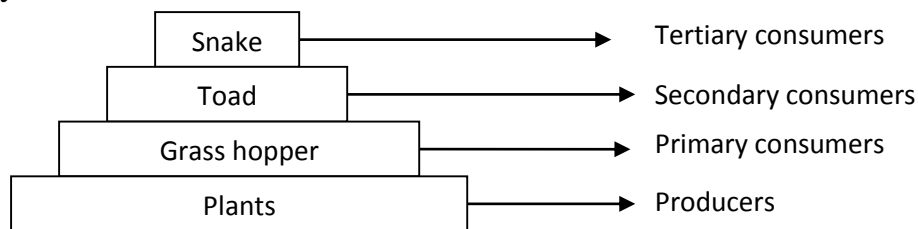

d) The number of grass hopper increases and that of plants decreases due to the increase in the number of grass hopper.

**2. Pyramid of biomass:**

This gives the mass of the organism at each trophic level. Biomass refers to the mass of a living organism. Biomass decreases from producers to tertiary consumers. Producers have a higher biomass than all other trophic levels.

Considering the food chain in the **example 2**, above, the pyramid of biomass would be.

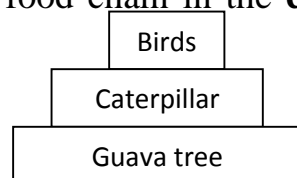

Even if the guava is one, it has a bigger biomass than caterpillars and caterpillars have a larger biomass than birds.

In most cases the pyramid of bio mass is constructed using dry weight of organisms. This is because the fresh mass of an organism varies so much with water content.

Dry weight is the mass of an organism without water.

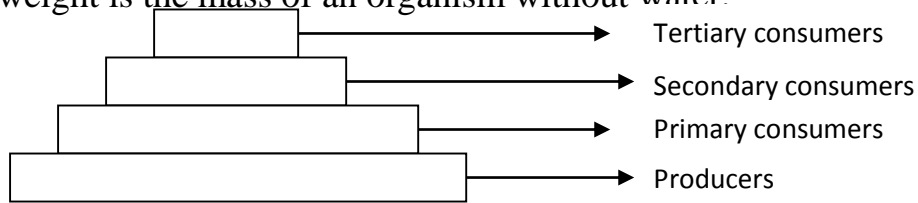

The problem with biomass is that it varies greatly as the organism grows. Using a pyramid of energy can solve this problem.

### 3. Pyramid of energy:

This shows the amount of energy at each trophic level. Energy decreases with succeeding trophic levels. Producers contain more energy than tertiary consumers. The pyramid of energy gives the r

#### Pyramid of energy.

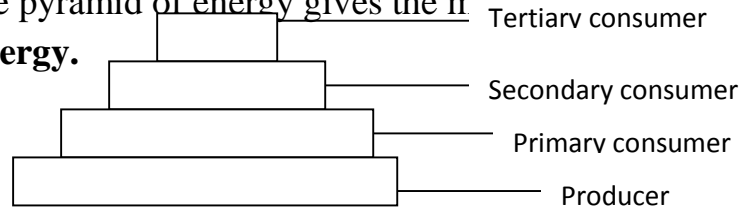

### Energy flow in an ecosystem

Energy flows through food chains and food webs. Energy is obtained from the sun by green plants. The plants trap light energy and use it to carry out photosynthesis. During photosynthesis, light energy is converted into chemical energy. When primary consumers eat the plants, they obtain this energy. The energy is then passed on to other organisms through their feeding relationships.

At each trophic (feeding) level there is loss of energy because;

- i) Some energy is used up during respiration.
- ii) Some energy is lost from herbivores in form of indigestible plant material.
- iii) Some organisms die before they are eaten.
- iv) Some of the chemical energy is converted into other forms such as sound, light energy, heat energy, which easily escapes from the organisms.

At each trophic level, decomposers (saprophytes) such as bacteria and fungi break down dead organic matter to release some of the energy locked in it.

## POPULATIONS

Population is the total number of organisms of same species living in a particular area at a given time.

Organisms live in a population in order to:

- ✓ Gain more protection as the population
- ✓ Have increased chances of gathering mates and breeding.
- ✓ Ability to get shelter

However organisms in a population face:

- ✓ High chances of overcrowding
- ✓ High competition among themselves for food, shelter, etc.
- ✓ Increased chances of predation.

## PATTERNS OF POPULATION DISPERSION

The distribution of individuals in an area is known as population dispersion. It refers to the way individuals in a population are distributed in a particular area in which they are living.

### Types of population dispersion

#### 1. Random dispersion.

This happens when the environment is uniform throughout the area and therefore there is no tendency to aggregate. There is no particular order of distribution

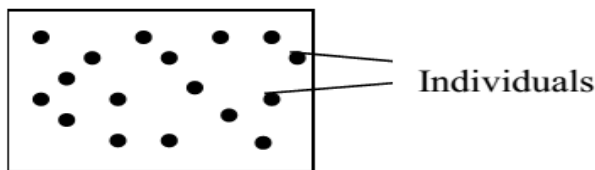

#### 2. Uniform dispersion.

This occurs when competition is very high due to scarcity of resources and the organisms are evenly distributed in all parts of the environment.

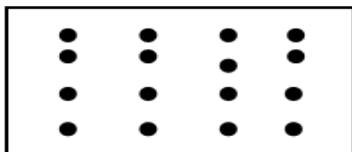

#### 3. Clumped dispersion

Here organisms are found in high numbers in particular areas and low numbers in other areas. This results from:

1. Self-dispersal
2. Resources being clumped
3. Tendency of individuals in an area to live together.
4. Territorial behaviour
5. Aggregate behaviour where organisms feed together in a group.

There are two types of clumped dispersal.

#### **Regular illustration**

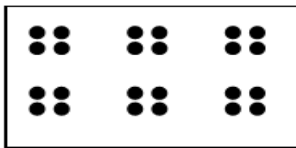

#### **Irregular illustration**



#### **Importance of distribution**

- ✓ Individuals acquire themselves enough space within which they can live and breed i.e. a home with enough resources and suitable breeding resources.
- ✓ It improves on the chances of obtaining a mate.

### **POPULATION GROWTH**

This refers to the increase in number of organisms of the same species. Growth takes place when the birth rate is higher than the death rate. The increase in number over a period of time when plotted on a graph makes what is known as a growth curve.

#### **Carrying capacity**

This is the total population the environment can support at a particular time without exhausting the resources.

#### **The population growth curve**

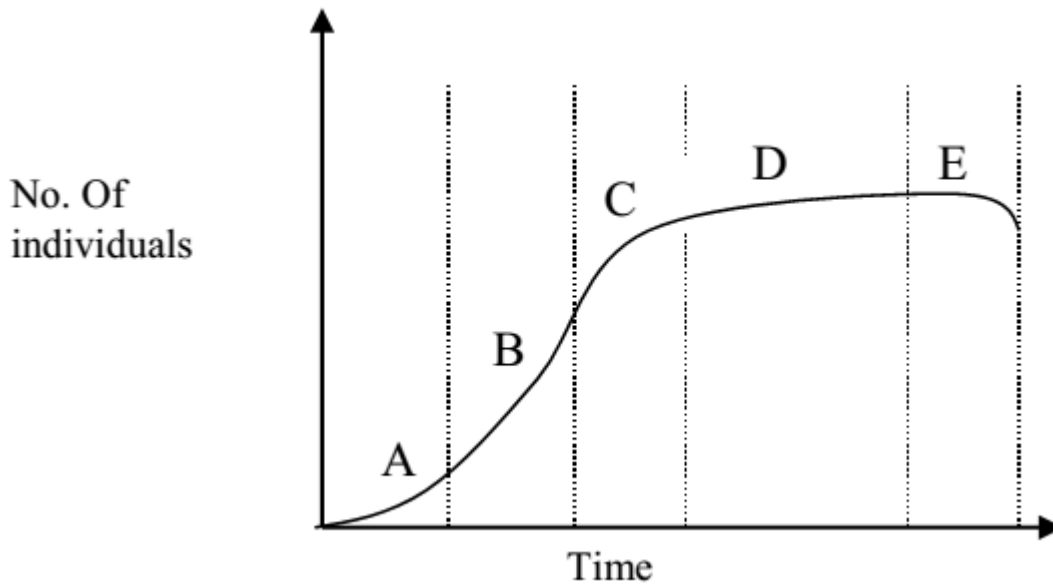

The growth curve is S-shaped and it is referred to as a sigmoid curve. It is divided into five phases.

**Phase A**

In this phase the rate of growth is low because the numbers of organisms multiplying are few and the organisms are still adapting to the conditions.

**Phase B**

The rate of growth increases because the number of reproducing organisms has increased and the organisms have adapted to the conditions.

**Phase C**

The rate of growth starts to slow down as the organisms start to die. This is due to the fact that their number has become big and they have started competing for food, shelter, mates and space. The available resources cannot support a big number of organisms.

**Phase D**

In this phase, the rate of birth is equal to the rate of death hence the population remains constant.

**Phase E**

The population is declining because the rate of birth is lower than the death rate. The organisms die at a higher rate due to competition between them and the exhaustion of resources.

**Growth of the human population**

The population is presently growing exponentially. This is shown in the human population growth curve below:

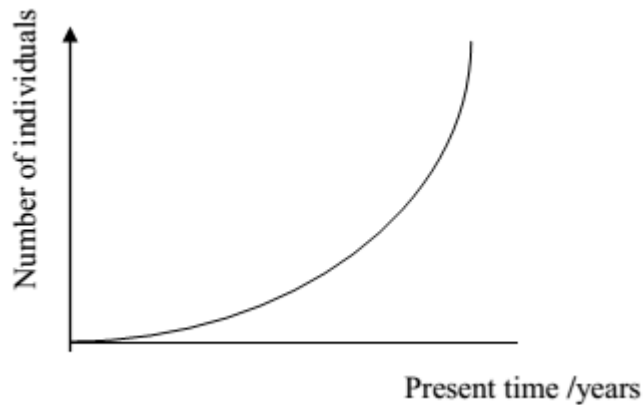

The exponential human growth is usually due to:

- ✓ Advancement in science and technology leading to prevention of infectious diseases.
- ✓ Early warning on natural catastrophes.
- ✓ Proper nutrition.
- ✓ Decrease in infant mortality.
- ✓ Increase in life expectancy in developing countries.
- ✓ Increasing agriculture hence leading into more food.

### **Factors affecting population growth**

These factors are grouped into two categories.

1. **Density dependent factors**; these are factors whose effect depend on the size of the population, e.g. food, diseases, space, pollution, predation, competition, light, etc.
2. **Density independent factors**; these are factors which affect the population regardless of the population size e.g. earth quakes, floods, droughts, thunderstorm, lightening, fire strong winds, etc.

### **POPULATION SIZE**

This refers to the number of organisms of the same species in a particular area at a particular time.

### **Determinants of population size**

Population size depends on the following factors.

1. **Natality** (birth rate). This is the frequency of birth. Increase in natality results into increase in population size.

2. **Mortality** (death rate). This is the frequency of deaths. When the death rate increases, the population size decreases.
3. **Emigration**. This is the movement of individuals out of the population. It results into a decrease in population size.
4. **Immigration**. This is the movement of individuals into the population. It causes the population to increase.

## **METHODS OF ESTIMATING POPULATION SIZE**

### **1. Direct count**

This is suitable for large organisms living in an open habitat, e.g. elephants, lions and buffaloes. In this method, one moves through the area along predetermined paths and counts the organisms in question. When counting aggressive animals, a low flying aircraft is used. Several counts are made and an average is taken to get an estimate of a particular area.

### **2. Aerial photography**

This is suitable for large organisms living in an open area. Photographs are taken from a low flying aircraft over the study area. When the photographs are developed the number of organisms in the photographs is determined. The photographs are taken several times and the average number is taken for the population of that particular organism in the area.

### **3. The quadrat**

This is a method used for small static organisms like plants or slow moving animals. A quadrat is a square metal or wooden frame of 1-meter long sides. It therefore encloses an area of  $1\text{m}^2$ . The quadrat is thrown at random in the study area and the individuals covered counted. Several quadrats are thrown at random and the average number of organisms is taken.

The average number is then multiplied by the total area of the study to get the estimated population.

### **4. Line transect method:**

This method involves lying along measuring tapes along a selected strip within the habitat. A record is made of the organisms touching or covered by a line at all points at regular intervals.

### 5. Belt transect method:

This is a strip usually a meter wide marked by putting a second line transect parallel to the other. The species between the line are carefully recorded.

### 6. Capture mark recapture method:

This is suitable for animals, which are fast moving. E.g. rats and grasshoppers.

In this method animals in an environment are captured and counted ( $n_1$ ). They are then marked and released back into the environment.

The traps are then laid after a given period of time.

The organisms captured are counted ( $n_2$ ).

The organisms that were marked and recaptured are also counted ( $n_3$ ). The population is then calculated from:

Total population =  $\frac{\text{number of individuals in 1}^{\text{st}} \text{ capture} \times \text{number of individuals in 2}^{\text{nd}} \text{ capture}}{\text{Number of individual in 2}^{\text{nd}} \text{ capture with a mark}}$

$$P = \frac{n_1 \times n_2}{n_3}$$

Where;

P = population

$n_1$  = number in the first capture

$n_2$  = number in the second capture

$n_3$  = number in the second capture which are marked.

### Examples

1. 30 rats were caught in the bush around the school. They were all marked with ink on the tails and released. After 3 days 20 rats were caught from the same area. 6 out of the 20 rats had a mark. Estimate the population of rats in this bush.

#### Solution.

Using.  $P = \frac{n_1 \times n_2}{n_3}$

P = population.

$n_1$  = 30

$n_2$  = 20

$n_3$  = 6

$$P = \frac{30 \times 20}{6}$$

= 100 rats.

**Assignment:**

Arthur captured and marked and replaced 45 cockroaches on the first day. She captured 26 cockroaches from the same area 17 of which were not marked. Estimate the population in the area.

## **INTERACTIONS BETWEEN POPULATION**

Individual organisms in the population do not live in isolation in a community. They are continuously interacting with each other in the following ways:

- ✓ Competition
- ✓ Predation
- ✓ Mutualism
- ✓ Parasitism

## **COMPETITION**

As the population of the individuals increase, the resources become limited and the organisms compete for them. Examples of resources competed for include, food, space, mates, etc. Competition is of two types;

- 1. Interspecific competition;** this is the competition between organisms of different species, e.g. the competition between goats and cattle for pastures.
- 2. Intraspecific competition;** this is the competition between organisms of the same species, e.g. the competition between goats for grass.

## **PREDATION**

This is the relationship between a predator and the prey.

A predator is an organism that hunts and kills another organism (prey) for food.

A prey is an organism that is hunted and killed for food.

## The graph showing the predator-prey relationship

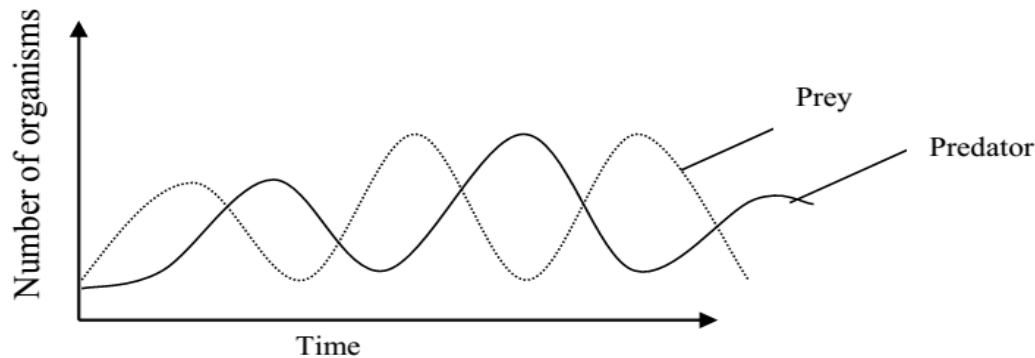

### Description and explanation of the graph:

The population of the prey is higher than that of the predator at the start. This leads to an increase in the number of predators.

The prey reaches a peak earlier than the predators. Further increase in the predator population leads to a decrease in the prey population due to the fact that they are being fed on by the predators. When the number of prey goes down, the predators starve and this makes their population to go down. When the predator number decreases below that of the prey, the population of the prey increases again due to the fact that the predators are few which would feed on them.

Note. Both the predator and prey control the population of each other.

### Adaptations of predators that enable them to feed on prey

1. They have keen eyesight to see their prey.
2. They have strong jaw muscles to tear flesh of the prey.
3. They have sharp claws to hold and kill their prey.
4. They move very fast to enable them chase the prey.
5. They have streamlined bodies to cut through air during movement.
6. Some have very sharp canines to tear flesh of their prey.
7. They have colours, which help them to camouflage.

### Adaptations of the prey to avoid being eaten by predators

1. They perceive sound with high accuracy and are able to sense their predators at a distance.
2. They are very fast in movement to escape from their predators.
3. They have developed structures for defense such as horns.
4. They normally move in groups to scare their predators.
5. They prefer to stay in areas, which give them good visibility such as grasslands.

6. They have colours, which help them to camouflage.
7. Mimicry; this is where a palatable harmless organism attains colours of an unpalatable harmful organism and it is confused for a harmful organism.

## **FEEDING RELATIONSHIPS BETWEEN ORGANISMS**

### **SYMBIOSIS**

This is the relationship between two organisms of different species in which both organisms derive benefits from the association.

#### **Examples**

1. In the stomach of cattle and sheep there are bacteria. These bacteria help to digest cellulose, which is used by the cow. The bacteria benefits by getting food and shelter from the cow.
2. The nitrogen-fixing bacteria in root nodules of leguminous plants. The bacteria provide nitrates to the plant by converting nitrogen to nitrates and the bacteria are protected in the root nodules. The bacteria may also use sugars produced by the plant during photosynthesis
3. The lichen is composed of a fungus and filament of algae. The fungus provides water and mineral salts to the algae and the fungus benefits by using the sugars produced by the algae

### **COMMENSALISM**

This is the relationship between the organisms of different species in which only one organism (commensal) benefits but the other organism neither benefits nor loses.

#### **Examples.**

1. The shark and the ramora. The ramora is a small fish that lives as a commensal attached to the shark by its sucker. When the shark feeds, the ramora feeds on left overs of the shark. The shark neither benefits nor loses.
2. The cattle/buffalos and the egret. The egret gets food in form of insects forced to fly by grazing animals. The cattle do not gain and do not lose.

### **PARASITISM**

This is the association between two organisms in which one (the parasite) is nutritionally dependent on the other (host). The host is harmed in the process.

Parasites are divided into two categories:

1. **Endo-parasites**; these are parasites that live inside the body of the host, e.g. plasmodium and HIV
2. **Ectoparasites**; these are parasites which live outside the body of the host, e.g. ticks, lice and flea.

## **Parasites can also be described as:**

**Obligate parasites;** these are parasites which cannot live without their hosts. Examples of obligate parasites are plasmodium and HIV.

**Facultative parasites;** these are parasites that can spend some time outside the bodies of their hosts. E.g. Ticks.

**Incidental parasites;** these are organisms that are not usually parasite but may become parasitic due to factors like lack of their normal food, increase in their numbers, etc. an example is *Entamoeba gingivalis*.

### **Problems faced by parasites**

- i) Finding the host may be difficult since most hosts keep on moving from one place to another.
- ii) Deficiency of food in case the host has similar deficiency.
- iii) They may be killed by the hosts' immune reactions.
- iv) Death of parasites incase the host dies due to starvation.
- v) Inabilities to live in a wide range of environment since most of them have low power of locomotion i.e. they are not able to live freely.

To overcome some of these problems, the parasites have a number of adaptations so as to cope up with their mode of life.

### **General adaptations of parasites**

1. They have means of attachment to the host.
2. They have penetrative devices for entering and feeding on the host
3. They show degeneration of unnecessary organs and systems to reduce on their body size in order to fit in the host. e.g. eyes
4. They produce many eggs, seeds or spores to enhance their survival.
5. They have vector intermediate hosts
6. They produce resistant stages to survive in periods when they are outside the host

### **Types of hosts**

#### **1. Intermediate host:**

This is the host in which the larvae stage of parasites develops from (secondary host).

#### **2. Primary host (infinite host):**

This is the host in which sexual reproduction of a parasite occurs from.

## EXAMPLES OF PARASITES

### 1. PLASMODIUM SPP

This is a protozoan parasite that causes malaria. It is transmitted from one person to another by the female anopheles mosquito. The mosquito acts as the vector.

#### Life cycle of plasmodium

- ✓ Mosquitoes bite a human and inject saliva to stop blood from clotting in its alimentally canal.
- ✓ In the process hundreds of parasites are moved from the mosquito into the person.
- ✓ The parasites move to the liver through the circulatory system.
- ✓ They burrow in the liver cells and reproduce very fast.
- ✓ Within one to two weeks, the daughter cells break out of the liver and move to invade the red blood cells.
- ✓ In the red blood cells they reproduce rapidly causing the cells to rupture and invade other red blood cells.
- ✓ They then attack new red blood cells causing them to rupture also.
- ✓ If a mosquito sucks blood from an infected person, it will take up these parasites in the red blood cells.
- ✓ The parasites reproduce in the mosquito and migrate to the salivary glands ready to infect the next person when that mosquito bites.

#### Note.

Each time the daughter cells of plasmodia are released, thousands of red blood cells rupture and the patient experiences chills accompanied by shivering and sweating. The patient may also become anemic due to loss of red blood cells.

#### Control of malaria

- ✓ Spraying the walls of dwelling places with insecticides. The insecticide may also be sprayed directly on the mosquito vector.
- ✓ Draining all stagnant water to prevent mosquitoes from breeding there.
- ✓ Removing broken bottles, old tins, old car tyres, e.t.c in which water collects. This also prevents breeding of mosquitoes.
- ✓ Sleeping under mosquito nets
- ✓ Treating the infected people using anti-malarial drugs.

## **2. THE TAPEWORM**

These are flatworms belonging to phylum platyhelminthes. There are two common species known.

- i) Taenia sagnata (beef tape worm)
- ii) Taenia solium (pork tape worm)

They live in the small intestine of humans attached to the wall of the small intestine by hooks and suckers. They absorb nutrients from the digested food.

### **Life cycle of a tapeworm**

- ✓ Within the infected human being, the segments containing fertilized eggs break off and pass out in faeces.
- ✓ These eggs then tend to become attached to leaf blades of vegetation.
- ✓ When the eggs are eaten by the pig or cow depending on the species of the tapeworm, they develop into embryos.
- ✓ The released embryos burrow through the intestinal walls into the blood, which transports them to the muscles.
- ✓ Within the muscles they develop into bladder worms.
- ✓ If uncooked or partially cooked, meat from an infected cow or pig is eaten, the bladder worms are released in the intestines where they develop into tapeworms.

### **Control**

1. Avoid eating raw or half cooked meat.
2. By regular de-worming of infected individuals
3. By proper disposal of wastes
4. Inspection of meat before it is considered fit for human consumption.

### **Adaptations of tapeworms to parasitic life**

- i) They have lost the alimentally canal hence absorb already digested food over the entire body surface by diffusion.
- ii) They have a thick cuticle to prevent attack by digestive enzymes of the host.
- iii) They produce substances that inactivate the enzymes of the host.
- iv) Each mature proglotids of the tapeworm contains both male and female reproductive organs (hermaphrodites) hence fertilizes itself.
- v) They produce large numbers of eggs to ensure their survival.
- vi) They have suckers for attachment to intestinal walls. This prevents the tape worm from being dislodged by host peristaltic movements
- vii) They have resistant stages in their lifecycles with secondary and intermediate hosts to ensure survival during adverse conditions.
- viii) There is loss of unwanted organs like locomotally organs, eyes, etc. to ensure that they occupy as little space as possible within the host.

ix) They have the ability to respire anaerobically and can survive in an oxygen free environment.

### 3. SCHISTOSOMES

These are flat worms known as flukes. They are parasites that cause bilharzia (schistosomiasis)

#### Life cycle

- ✓ Schistosoma requires the use of two hosts to complete its life cycle
- ✓ Eggs are shed in faeces or urine of an infected human
- ✓ Eggs can survive up to a week in dry land
- ✓ If faeces end up in water, larvae called miracidia hatch
- ✓ Find a snail and penetrate its foot
- ✓ Transform into primary sporocysts ( another larval form)
- ✓ Primary sporocysts multiply asexually into secondary sporocysts
- ✓ Travel to snails hepatopancreas
- ✓ Multiply asexually into many cercariae ( another larval form)
- ✓ Cercariae exit the snail into the water (survive for about 48 hours )
- ✓ Swim and attach to human skin with suckers
- ✓ Find a suitable spot (e.g a hair follicle) and penetrate the skin using special enzymes
- ✓ Transform into schistosomulae as they enter(another larval form)
- ✓ Only head parts enter, tails remain behind
- ✓ After a few days in rain, enter into the blood stream through dermal lymphatic vessels or blood venules
- ✓ Travel in blood stream to get to specific blood veins
- ✓ Schistosoma reaches maturity in 6-8 weeks in humans
- ✓ Developed adult male and female find each other and pair up
- ✓ Males make a gynaecophoric channel for longer thinner females to reside
- ✓ The pair travel to rectal and mesenteric veins
- ✓ Attach to venous wall with ventral and oral suckers
- ✓ Females lay eggs on endothelial lining of the venous capillary walls
- ✓ Some eggs are flushed by circulating blood ending up causing inflammation in organs like liver, lungs
- ✓ Most eggs travel to lumen of intestinal tract( for *S. mansoni*) ureters and bladder(for *S. haematobium*)
- ✓ Mature eggs produce special enzymes and can penetrate many membranes like renal veins or intestinal walls
- ✓ Eggs get out of the body in faeces or urine
- ✓ Cycle starts again

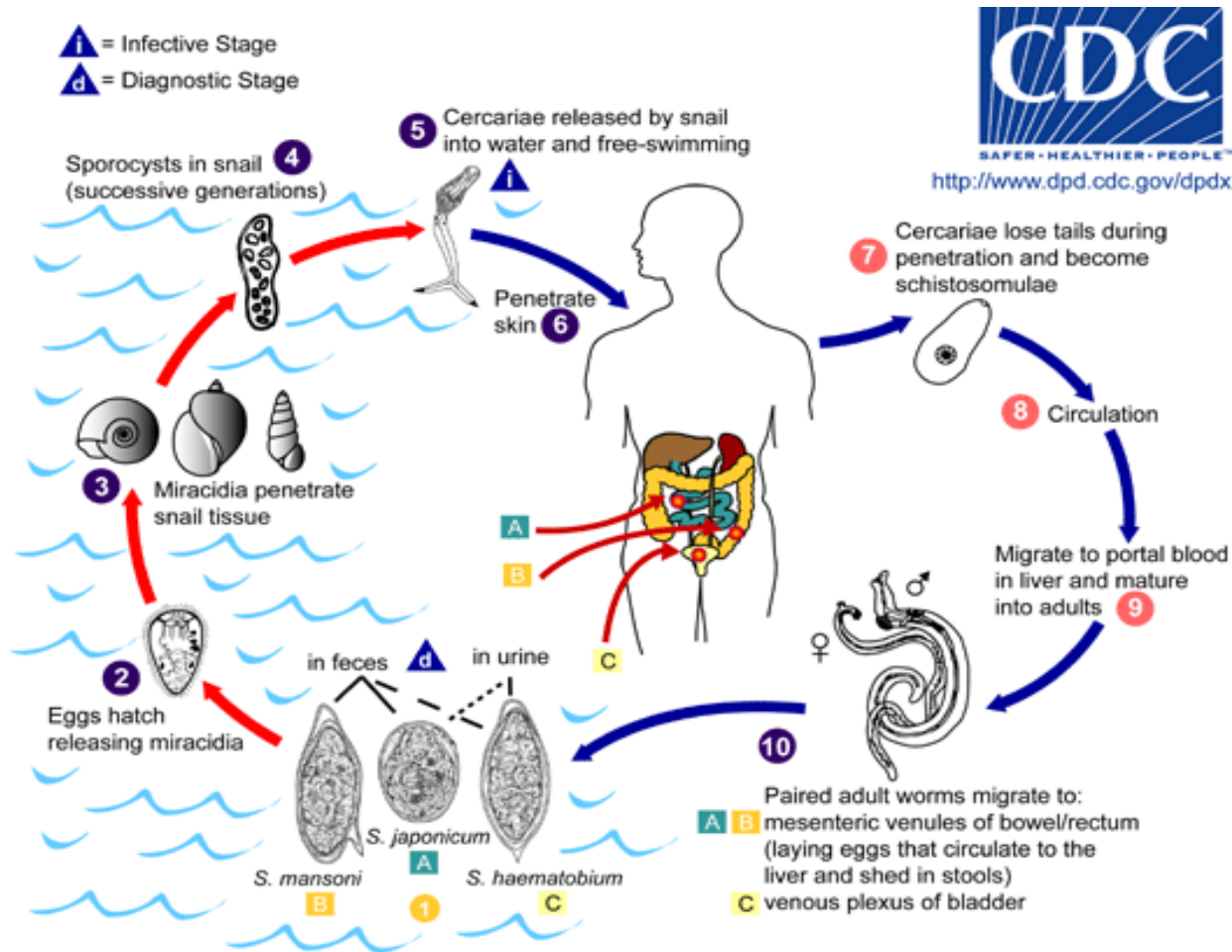

### Control

- i) Boil all the water for drinking and bathing
- ii) Proper disposal of feces and all wastes
- iii) Kill snails using chemicals
- iv) Treatment of water in swimming pools
- v) Drain water around homes.

### 4. TRYPANOSOMES

These are protozoan parasites living in the blood stream. There are several different types of trypanosomes and they cause the following diseases.

1. Sleeping sickness (trypanosomiasis)
2. Nagana in cattle
3. Chagas disease.

### Life cycle of trypanosomes

The trypanosomes are transmitted by tsetse flies, which act as vectors as well as intermediate hosts.

When the tsetse fly bites an infected person, it sucks the blood from the capillary containing trypanosomes. The parasites multiply in the body of the

tsetsefly and migrate to the salivary glands. When the fly bites a healthy person, it injects saliva, which contains trypanosomes into the blood of the normal person. These multiply and cause symptoms of the disease and the cycle repeats.

### **Control**

- i) Clearing of bushes to destroy habitats for tsetseflies.
- ii) Spraying tsetseflies using insecticides
- iii) Treatment of infected animals
- iv) Sleeping under treated nets
- v) Putting infected areas under quarantine.
- vi) Using fly traps to trap tsetseflies

## **ECOLOGICAL SUCCESSION**

This is the successive replacement of organisms in a community from simple one to the most complex ones gradually. This is a gradual change in the composition of organisms in the area.

There are two types of succession.

1. Primary succession
2. Secondary succession

### **1. Primary succession**

This is a type of succession where life begins from a bare rock or new pond, which has never been occupied by living organisms before. The pioneer plants in such areas are those, which can withstand dry conditions with low water content and high temperatures. The first organisms to inhabit such an area are called pioneer organisms.

### **Stages of succession on a bare rock**

#### **Stage 1**

The lichens grow on bare rock. When they die, they decompose to form a thin layer of soil, which traps some moisture.

#### **Stage 2**

Mosses start growing on the soil formed by the decayed lichens. When the mosses die, they decay to form more soil.

#### **Stage 3**

The soil formed favours the growth of ferns.

#### Stage 4

Grasses start to grow due to coming in of favourable conditions such as moisture, enough soil for anchorage of the plants. During this stage some rodents may start coming in.

#### Stage 5

Shrubs are formed and they finally develop into trees. The trees form the climax community after which no other changes take place.

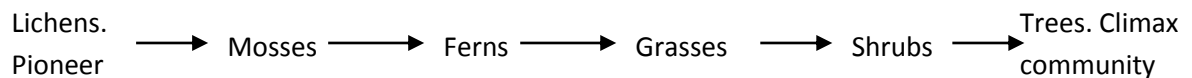

#### Succession in a new water pond



It takes several years for a climax community to be established. Any disturbance at any one level causes the process of succession to go back to the initial stages and it later on re-establishes. The ability of the community to re-establish after a disturbance is known as **resilience**.

A **climax community** is the final steady community that develops at the end of the succession process.

#### Characteristics of primary succession

- ✓ A pioneer community has very few species of plants and animals.
- ✓ The pioneer vegetation is shallow rooted
- ✓ The pioneer community colonizes a bare rock.
- ✓ It takes a long time to reach the climax community.

#### 2. Secondary succession

This is a type of succession, which takes place in an area, which has ever been occupied by organisms and destroyed by disasters like fire, floods and human activities. This type of succession is faster than primary succession.

#### Characteristics of secondary succession

- ✓ It begins on already formed soil or land.
- ✓ The pioneer community has a variety of plant and animal species.
- ✓ It takes a short time to reach the climax community
- ✓ The pioneer vegetation is of higher plants which are deep rooted.

### FIRE AS AN ECOLOGICAL FACTOR

### **Effects of fire to the ecosystem**

This is measured in the destruction made and it depends on the following factors.

1. Kind and amount of burning fuel e.g. grass generates less heat compared to wooden materials hence is less destructive.
2. Weather conditions. Fire is spread very fast in dry conditions and thus destroying a wide area of the eco system than in cold conditions. In cold conditions, fire spreads very slowly due to the high humidity hence causing less destruction.
3. Direction of wind. The effect of fire is great to the ecosystem if its burning against the direction of wind (back fire) because it burns in a particular area for a long period of time compared to forward fire.

### **Merits of fire**

- ✓ It breaks seed dormancy due to hard seed coat leading to fast germination.
- ✓ It increases recycling of nutrients in an ecosystem.
- ✓ It is used in selective weeding.
- ✓ It controls pests and diseases.
- ✓ It improves on herbage in an area.
- ✓ It improves on light penetration leading to rapid under growth in the forest.
- ✓ It improves on the visibility of the prey to predators by burning the vegetation cover down.

### **Demerits of fire**

- ✓ It destroys the habitat of animals which may cause extinction of some animals.
- ✓ It causes air pollution
- ✓ It destroys green plants which are producers of the community.
- ✓ It destroys animals in the ecosystem.
- ✓ It increases predation due to improved visibility.
- ✓ It leads to loss of some nutrients from the soil by decomposition e.g. humus and nitrates.

### **Forests as a renewable resource**

Forests are renewed by afforestation and avoiding deforestation.

### **Ecological importance of forests**

- ✓ They act as habitats of organisms.
- ✓ Source of food to organisms.
- ✓ Used in rain fall formation, this improves on the climate of an ecosystem.
- ✓ It forms soil by dropping litter which helps in decomposition into humus.

- ✓ Maintains plants and animal diversity.

### **Ecological effects of deforestation**

- ✓ Destruction of habitats of animals.
- ✓ It leads to soil erosion
- ✓ It leads to desertification.
- ✓ It increases CO<sub>2</sub> content in the atmosphere.
- ✓ Increases predation due to removal of vegetation cover.

### **Importance of forests to wild life conservation**

- ✓ They are sources of food to animals
- ✓ They are habitats to animals.
- ✓ Formation of rain falls to prevent drought.
- ✓ Reduces soil erosion thereby conserving soil fertility.
- ✓ Maintains the bio diversity for a variety of plant and animal species.
- ✓ Purifies the environment by removing CO<sub>2</sub> and adding oxygen.
- ✓ Provides a variety of litter that decomposes to form humus.
- ✓ Reduces predation of some wild animals.

## **POLLUTION**

This is the addition of substances to the environment to levels that harm or destroy living components of the environment (ecosystem). Substances that can cause pollution to the environment are called **pollutants**. E.g. sewerage, fertilizers, oil links, etc.

### **Types of pollution**

1. Water pollution
2. Air pollution
3. Noise pollution
4. Radioactive pollution
5. Sound pollution

### **Air pollution**

The main pollutants of air or atmosphere are poisonous gases e.g. SO<sub>2</sub>, CO<sub>2</sub>, NO<sub>2</sub>, and CO.

Some of these gases e.g. SO<sub>2</sub>, CO<sub>2</sub>, and CO form acidic components that destroy vegetation. Another air pollutant is smoke that causes poor vision, reduced light penetration, and reduction of photosynthesis by coating on plant leaves.

Excess gases in the atmosphere e.g. CO<sub>2</sub> and CFC<sup>s</sup> ( Chloro Floro Carbon) used in fridges cause global warming.

### **Water pollution**

This is as a result of addition of excess nutrients e.g. nitrates, phosphates, potassium to water bodies making them too nutritive leading to increased productivity of water. The highly productive lake is called eutrophic lake and the process of polluting water bodies by adding excess nutrients is called eutrophication. The main pollutants that cause eutrophication are fertilizers.

Domestic wastes drained in water bodies, industrial wastes e.g. detergents which contain a lot of phosphates and nitrates also cause eutrophication in the lake.

### **Eutrophication:**

This is the accumulation of nutrients (nitrates and phosphates) leading to increased growth of aquatic plants e.g. algae which decompose after death leading to a decrease of oxygen contents as a result of being utilized by decomposers of dead plants. Due to the decrease of oxygen content, in water, aquatic animals that need oxygen for respiration e.g. fish suffocate and die.

### **Soil pollution**

Use of excess fertilizers, herbicides, insecticides pollutes the soil. Excess herbicides and insecticides lead to death of living organisms in the soil there by reducing the rate of decomposition of dead matter.

Non degradable insecticides do not break down but accumulate in animals along the food chain to poisonous levels that can kill.

### **Activities of man that have led to the degradation of soil**

Environmental degradation is the process of destroying the quality of the environment. Human activities that have led to degradation of soil are:

1. Over stocking leading to over grazing that reduces the amount of vegetation cover to expose the soil there by encouraging soil erosion.
2. Deforestation exposing soil to agents of soil erosion.
3. Use of insecticides, pesticides and herbicides which cause the death of soil organisms hence affecting the rate of decomposition.
4. Burning of vegetation that removes the vegetation cover which encourages surface run off hence leading to soil erosion.

5. Mining, construction, quarrying leads to the destruction of soil structure which encourages soil erosion.
6. Digging or cultivating down slope also encourages soil erosion.

### **Radioactive pollution**

This is the release of radioactive chemicals into the environment in large amounts e.g atomic substances are from atomic bombs.

### **Human activities that lead to environmental pollution**

1. Drainage of excess un treated sewage into the water bodies causing eutrophication.
2. Application of excess fertilizers that are later eroded in water bodies.
3. Burning of vegetation that exposes the soil to erosion agent and it also leads to the emission of smoke which causes air pollution.
4. Emission of excess poisonous gases in the atmosphere e.g. SO<sub>2</sub>, CO<sub>2</sub> and CO form industries and automobiles which cause acidic rains.
5. Use of excess herbicides and insecticides which kill the soil organisms leading to decreased rate of decomposition.
6. Spilling of oil onto water bodies which leads to suffocation of aquatic animals.
7. Construction of noisy industries in town which cause sound pollution that can damage the hearing process of man.
8. Decomposition of non-biodegradable materials into the soil e.g. plastics, glass, etc. which destroy the soil structure.
9. Deforestation
10. Monoculture
11. Over stocking

### **UGANDA'S WATER BODIES**

The major water bodies in Uganda are lakes and rivers. They are pollution by sewage from industries; fertilizers used by man, oil from machines e.g. boat engines.

Water bodies are also invaded by water weeds especially water hyacinth which is a flowering plant which can also reproduce asexually and with a high rate of reproduction.

### **Effects of water hyacinth on water bodies**

- ✓ They hinder navigation
- ✓ They harbour dangerous animals e.g. snakes

- ✓ Reduction in the amount of fish in water bodies as some dies due to starvation.
- ✓ They reduce on the amount of light penetration in water column.
- ✓ Siltation of water bodies i.e. they become shallow as a result of death and decomposition of water hyacinth.
- ✓ Reduction in the amount of water in lakes as a result of increased rate of transpiration.
- ✓ They hinder smooth flow of water in lakes since they block the drainage channels.
- ✓ It has caused economic injuries to the country especially when trying to eradicate it.

### **Uses of water hyacinths**

- ✓ Production of biogas
- ✓ Feeds for cattle and pigs.
- ✓ A good fertilizer when used as mulches.
- ✓ A good raw material for art and craft.
- ✓ Raw material for making manure.

### **Methods of controlling the water hyacinth**

1. Physically or removing it manually by hand picking however it is not effective.
2. By use of machines (mechanical control) however the method is effective but expensive.
3. By using biological control methods e.g. use of bottles.
4. Use of herbicides (chemical control) and it involves the spraying of herbicides directly onto the weed. The method is quick but has the following demerits:
  - ✓ It contaminates water
  - ✓ Destruction of aquatic life especially fish
  - ✓ Pollution of water since the weed is not completely removed but decomposes in water.
  - ✓ It is expensive since it involves the use of space air crafts to apply it.